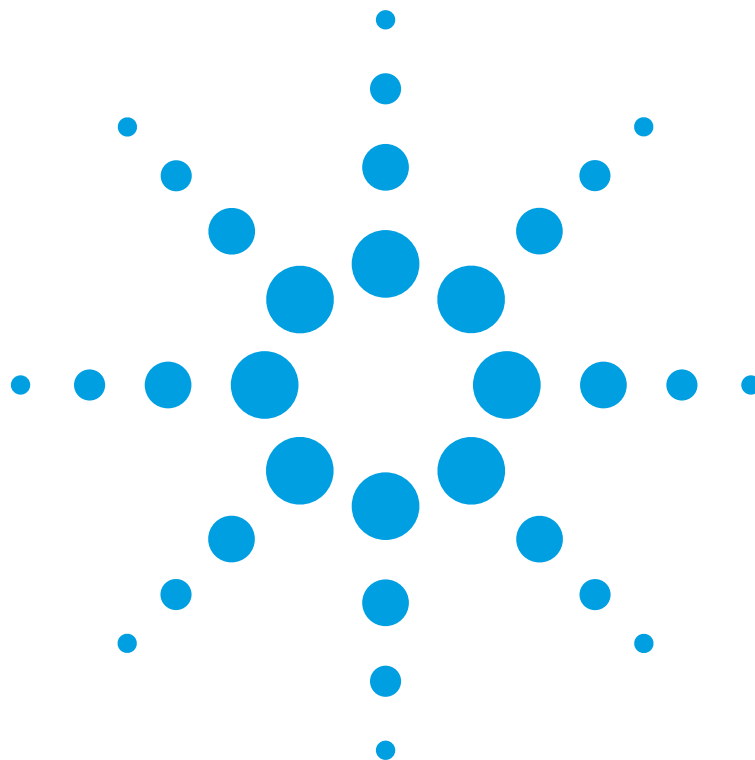


Agilent 8702E Lightwave Component Analyzer Reference



Agilent Technologies

© Copyright

Agilent Technologies 2001
All Rights Reserved. Reproduction, adaptation, or translation without prior written permission is prohibited, except as allowed under copyright laws.

Agilent Part No. 08702-91030
Printed in USA
March 2001

Agilent Technologies
Lightwave Division
3910 Brickway Boulevard-
Santa Rosa, CA 95403, USA

Notice.

The information contained in this document is subject to change without notice. Companies, names, and data used in examples herein are fictitious unless otherwise noted. Agilent Technologies makes no warranty of any kind with regard to this material, including but not limited to, the implied warranties of merchantability and fitness for a particular purpose. Agilent Technologies shall not be liable for errors contained herein or for incidental or consequential damages in connection with the furnishing, performance, or use of this material.

Restricted Rights Legend.

Use, duplication, or disclosure by the U.S. Government is subject to restrictions as set forth in subparagraph (c) (1) (ii) of the Rights in Technical Data and Computer Software clause at DFARS 252.227-7013 for DOD agencies, and subparagraphs (c) (1) and (c) (2) of the Commercial Computer Software Restricted Rights clause at FAR 52.227-19 for other agencies.

Warranty.

This Agilent Technologies instrument product is warranted against defects in material and workmanship for a period of one year from date of shipment. During the warranty period, Agilent Technologies will, at its option, either repair or replace products which prove to be defective. For warranty service or repair, this product must be returned to a service facility designated by Agilent Technologies. Buyer shall prepay shipping charges to Agilent Technologies and Agilent Technologies shall pay shipping charges to return the product to Buyer. However, Buyer shall pay all shipping charges, duties, and taxes for products returned to Agilent Technologies from another country.

Agilent Technologies warrants that its software and firmware designated by Agilent Technologies for use with an instrument will execute its programming instructions when properly installed on that instrument. Agilent Technologies does not warrant that the operation of the instrument, or software, or firmware will be uninterrupted or error-free.

Limitation of Warranty.

The foregoing warranty shall not apply to defects resulting from improper or inadequate maintenance by Buyer, Buyer-supplied software or interfacing, unauthorized modification or misuse, operation outside of the environmental specifications for the product, or improper site preparation or maintenance.

No other warranty is expressed or implied. Agilent Technologies specifically disclaims the implied warranties of merchantability and fitness for a particular purpose.

Exclusive Remedies.


The remedies provided herein are buyer's sole and exclusive remedies. Agilent Technologies shall not be liable for any direct, indirect, special, incidental, or consequential damages, whether based on contract, tort, or any other legal theory.


Safety Symbols. CAUTION


The *caution* sign denotes a hazard. It calls attention to a procedure which, if not correctly performed or adhered to, could result in damage to or destruction of the product. Do not proceed beyond a caution sign until the indicated conditions are fully understood and met.


WARNING


The *warning* sign denotes a hazard. It calls attention to a procedure which, if not correctly performed or adhered to, could result in injury or loss of life. Do not proceed beyond a warning sign until the indicated conditions are fully understood and met.

 The instruction manual symbol. The product is marked with this warning symbol when it is necessary for the user to refer to the instructions in the manual.

 The laser radiation symbol. This warning symbol is marked on products which have a laser output.

 The AC symbol is used to indicate the required nature of the line module input power.

 | The ON symbols are used to mark the positions of the instrument power line switch.

 ○ The OFF symbols are used to mark the positions of the instrument power line switch.

 The CE mark is a registered trademark of the European Community.

 The CSA mark is a registered trademark of the Canadian Standards Association.

 The C-Tick mark is a registered trademark of the Australian Spectrum Management Agency.

ISM1-A This text denotes the instrument is an Industrial Scientific and Medical Group 1 Class A product.

Typographical Conventions.

The following conventions are used in this book:

Key type for keys or text located on the keyboard or instrument.

Softkey type for key names that are displayed on the instrument's screen.

Display type for words or characters displayed on the computer's screen or instrument's display.

User type for words or characters that you type or enter.

Emphasis type for words or characters that emphasize some point or that are used as place holders for text that you type.

Contents

1 Menu Maps

2 Reference

- Instrument Options 2-3
- Available Accessories 2-5
- Power Cords 2-10
- Front Panel Features 2-12
- Analyzer Display 2-14
- Rear Panel Features and Connectors 2-16
- Unsupported Features 2-19
- Reference Documents 2-20
- Location of Softkeys 2-22
- Connectors, Adjustments, and Display Annotation 2-40
- Preset Conditions 2-43
- Power-on Conditions 2-51

3 Error Messages

- Error Messages in Alphabetical Order 3-3
- Error Messages in Numerical Order 3-24

4 Specifications and Regulatory Information

- Instrument Specifications 4-3
- Instrument Specifications (Option 011) 4-10
- Instrument General Characteristics 4-18
- Environmental Characteristics 4-22
- System E/E Characteristics 4-24
- System O/E Characteristics 4-53
- System E/O Characteristics 4-68
- System O/O Characteristics 4-83
- Lightwave Receiver Measurement Repeatability 4-94
- GPIB Interface 4-96
- Regulatory Information 4-97

5 Concepts

- How the Agilent 8702E Works 5-2
- How the Agilent 8702E Processes Data 5-5
- Using the Response Functions 5-10

Contents

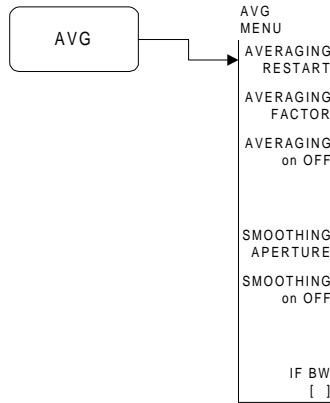
What is Measurement Calibration?	5-17
Understanding and Using Time Domain	5-67
Instrument Preset State and Memory Allocation	5-95



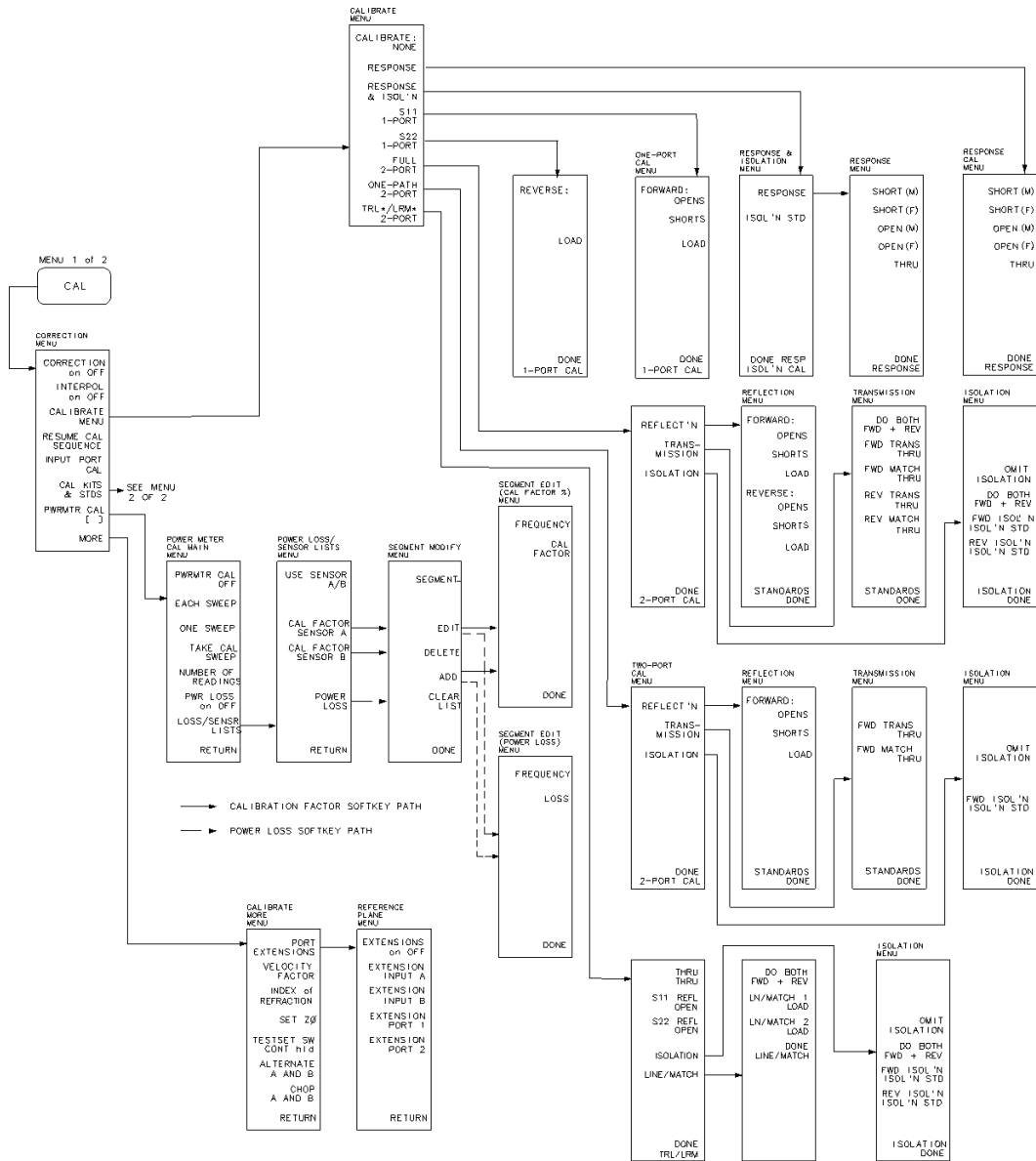
Menu Maps

Menu Maps

The menu maps that are in this chapter graphically represent the softkey menus. Maps for each softkey menu are shown in alphabetical order.

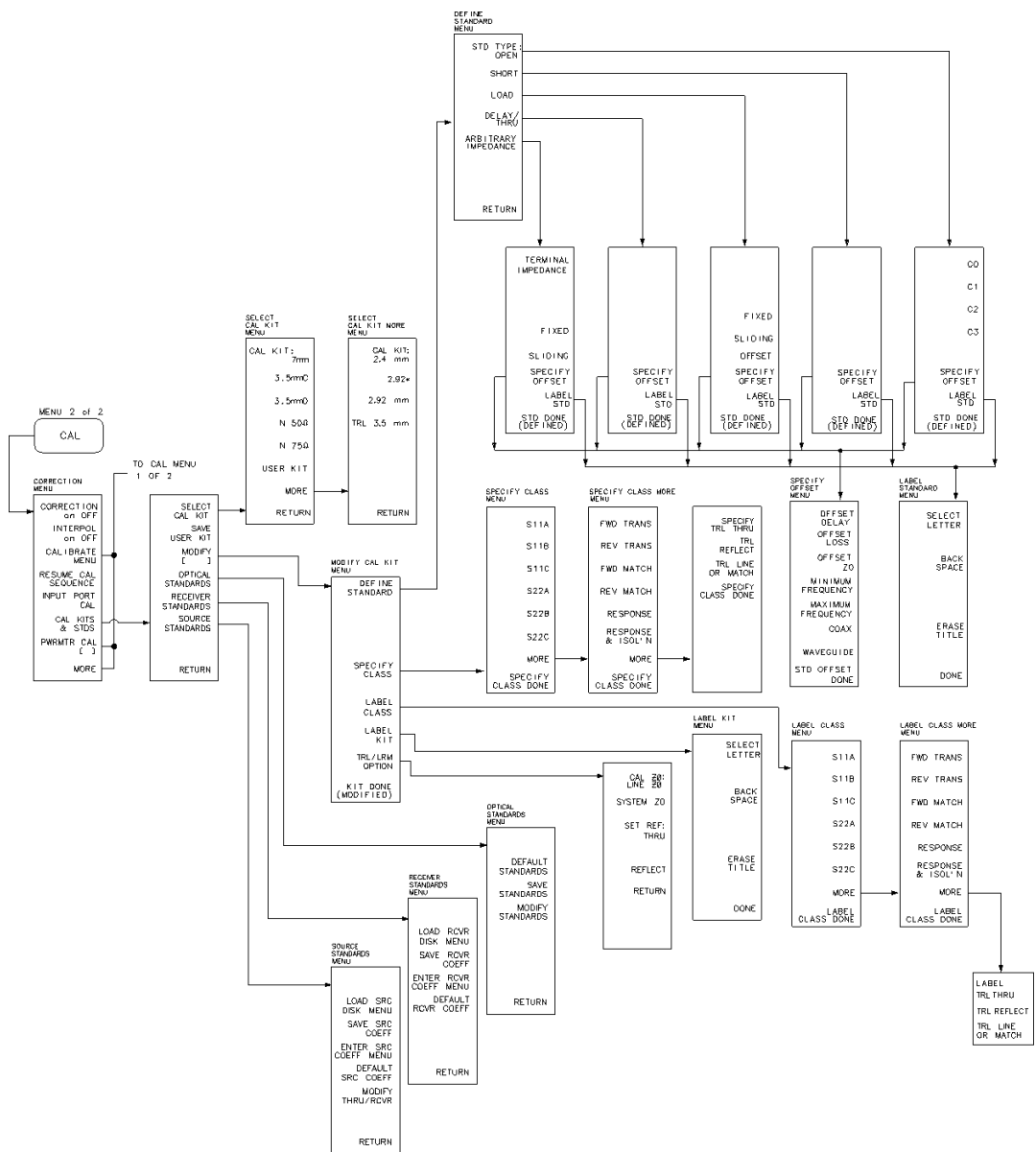


AVG menu map

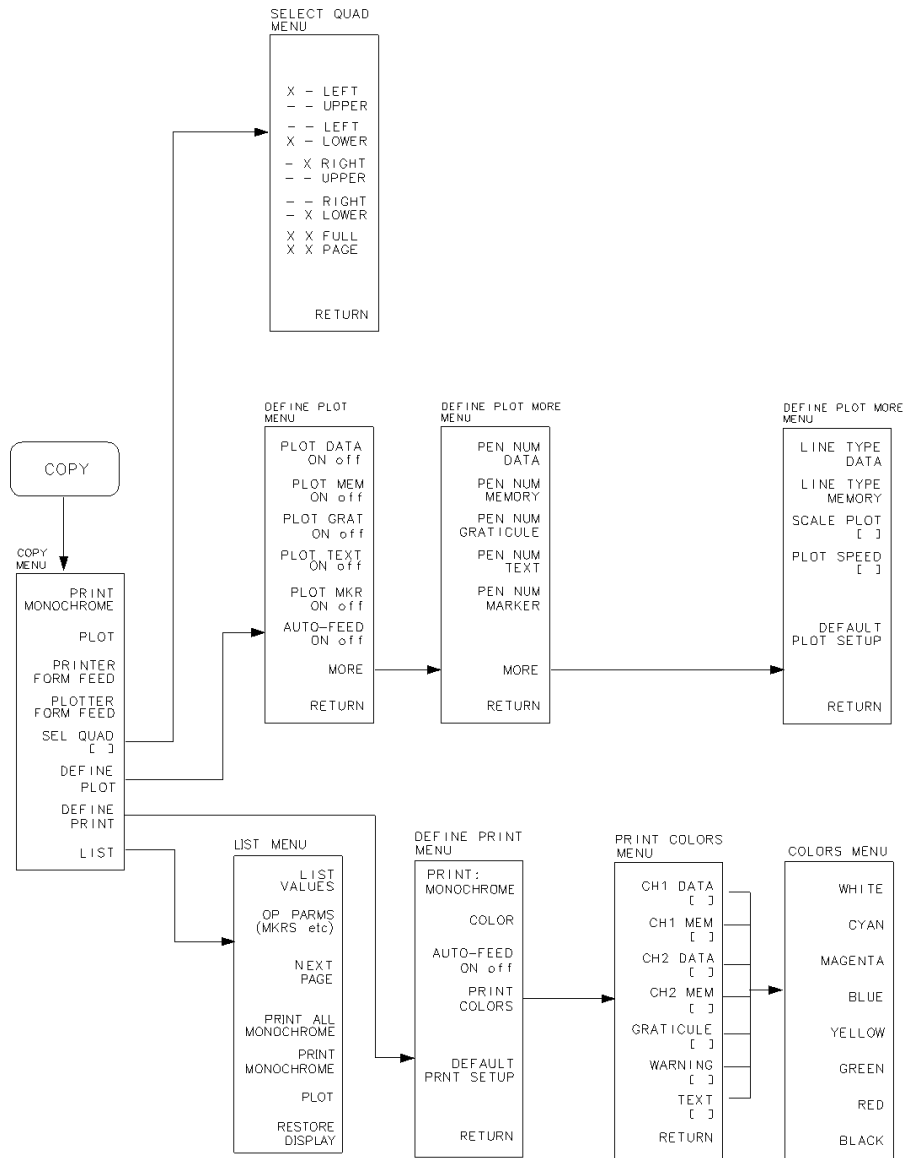


Menu Maps

Menu Maps



CAL menu map, 2 of 2

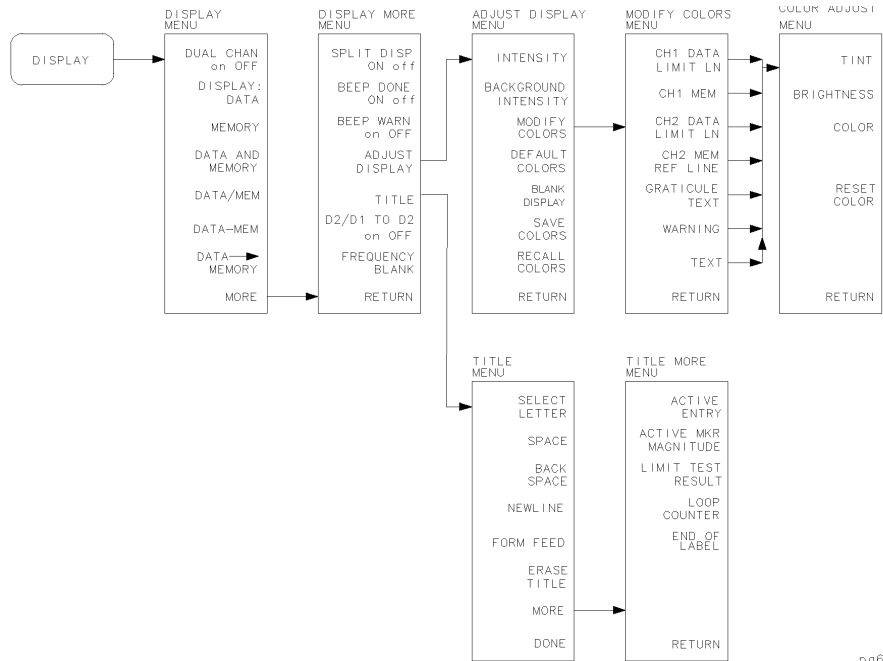


pg633d

COPY menu map

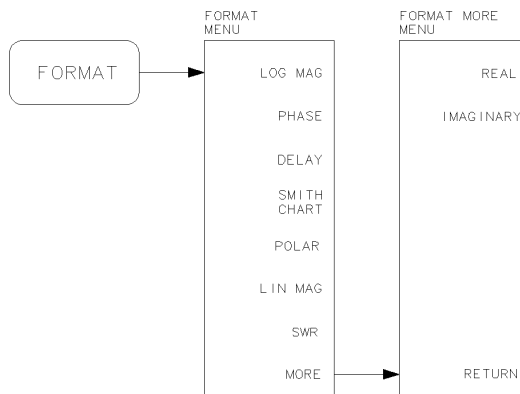
Menu Maps

Menu Maps



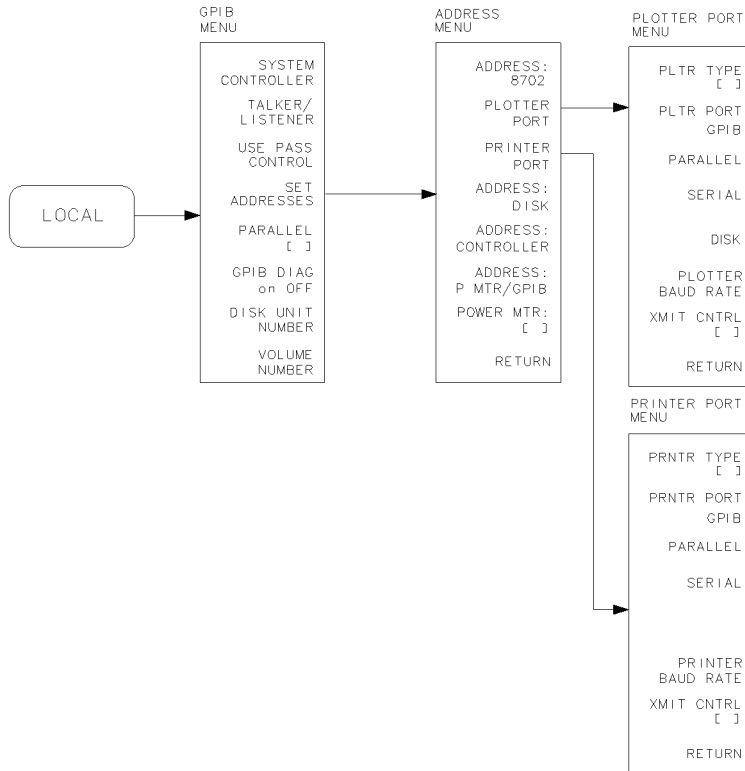
pg69d

DISPLAY menu map



pg67d

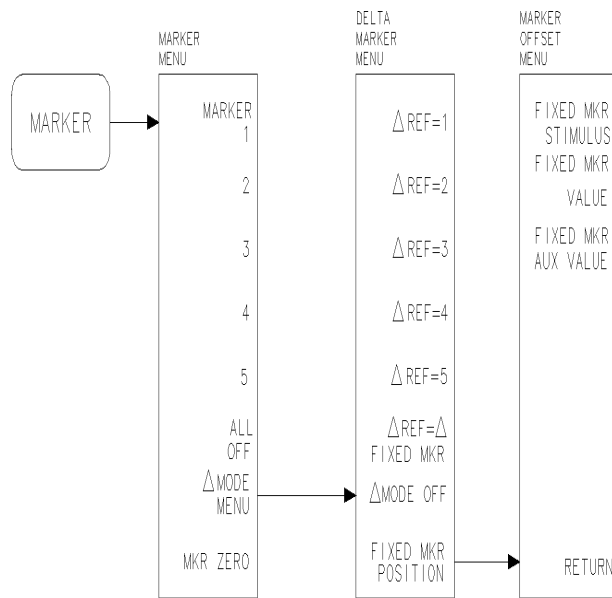
FORMAT menu map



pg630d

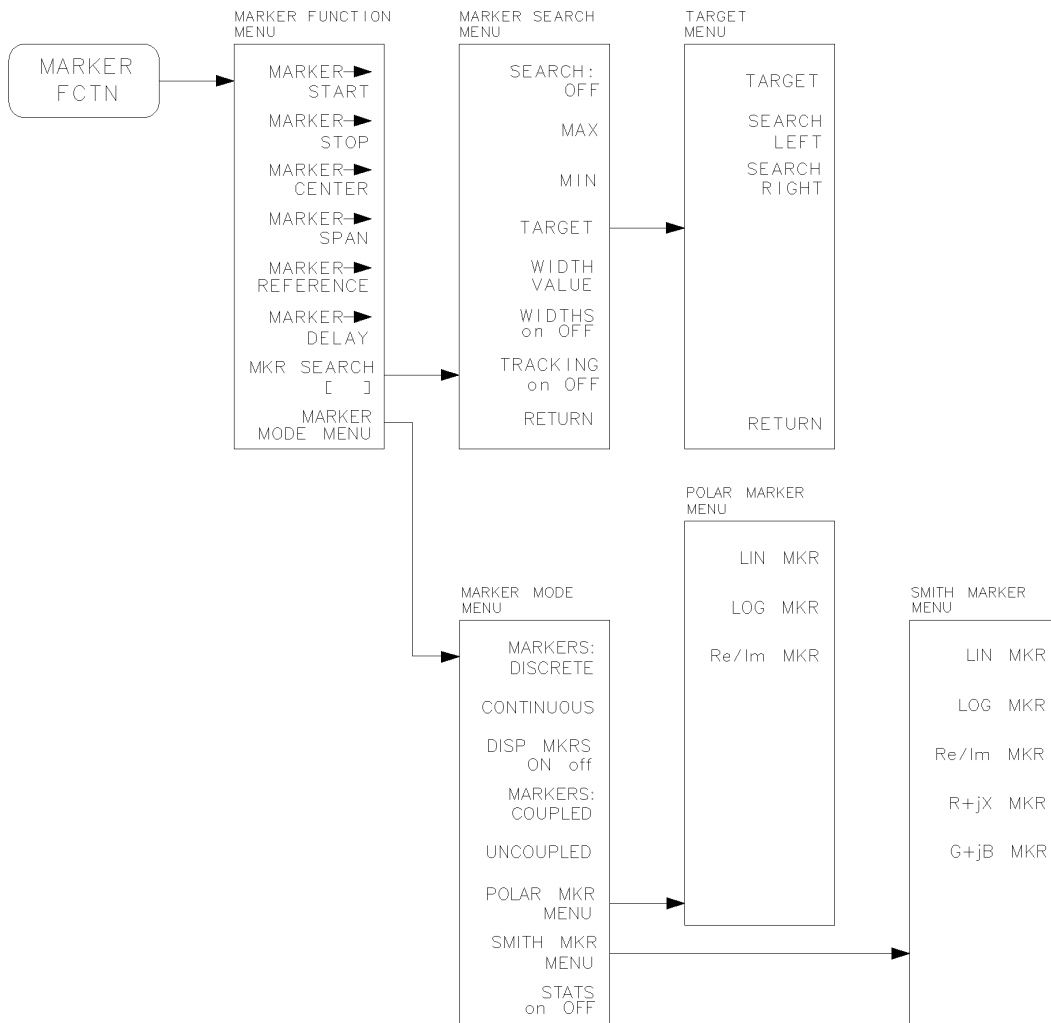
LOCAL menu map:

Menu Maps
Menu Maps



pg628d

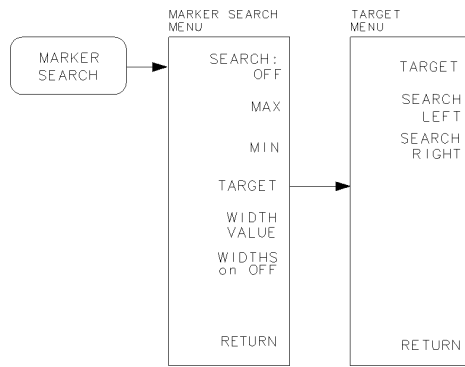
MARKER menu map



markfctn

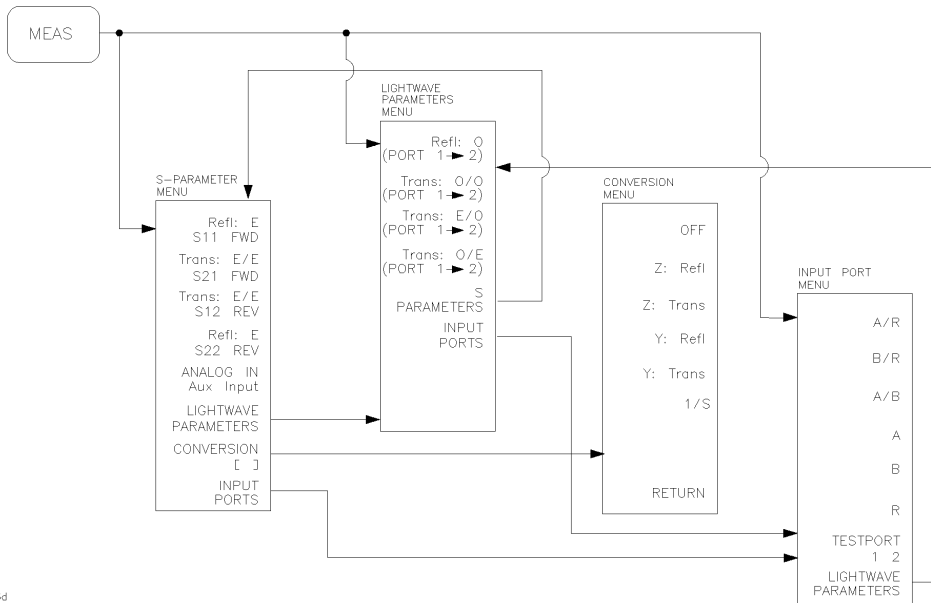
MARKER FCTN menu map

Menu Maps
Menu Maps



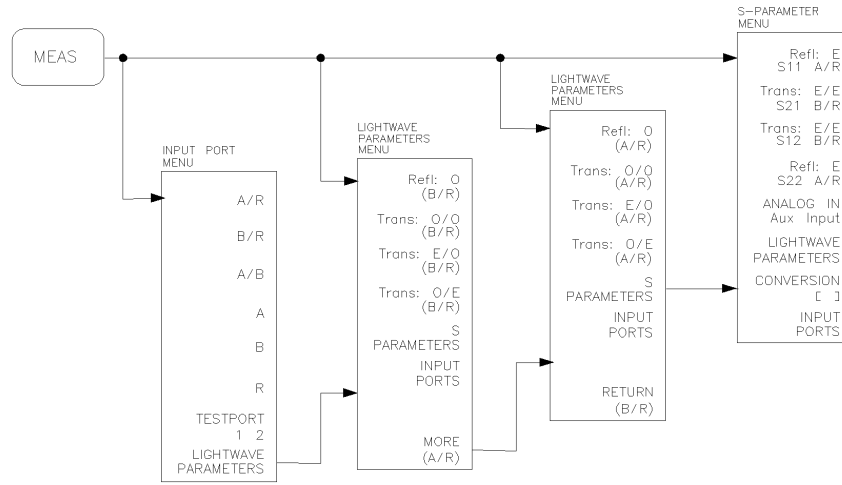
marksrch

MARKER SEARCH menu map

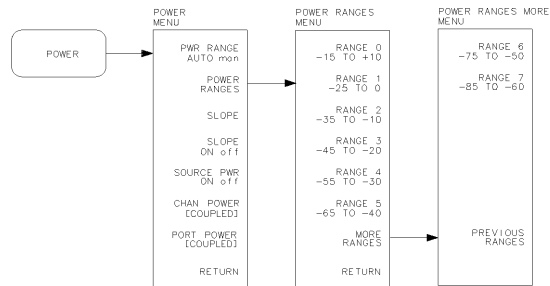


pg66d

MEAS menu map, standard and option 011 with test set



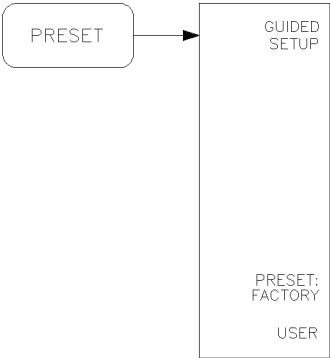
MEAS menu map, option 011, no test set



pg65a

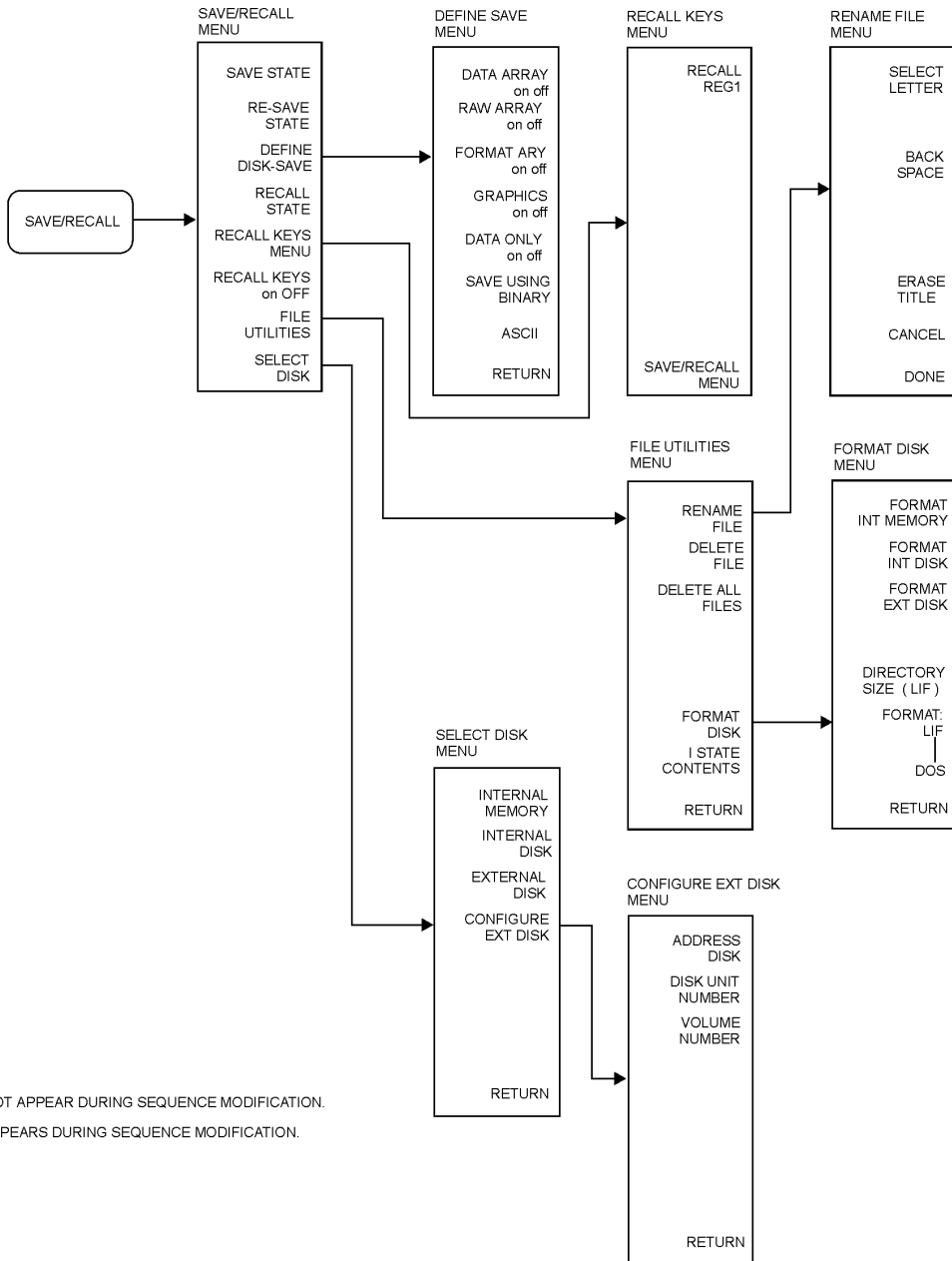
POWER menu map

Menu Maps



pg61

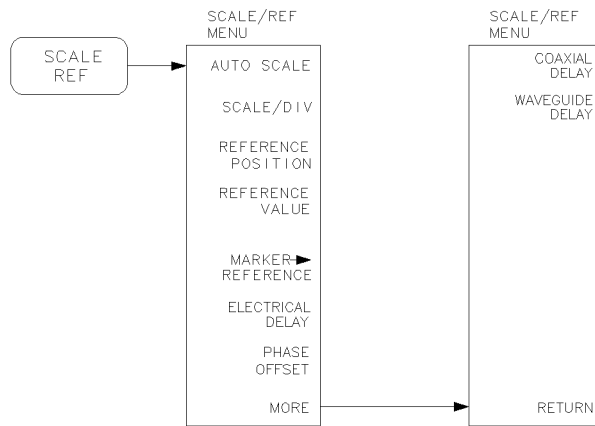
PRESET menu map



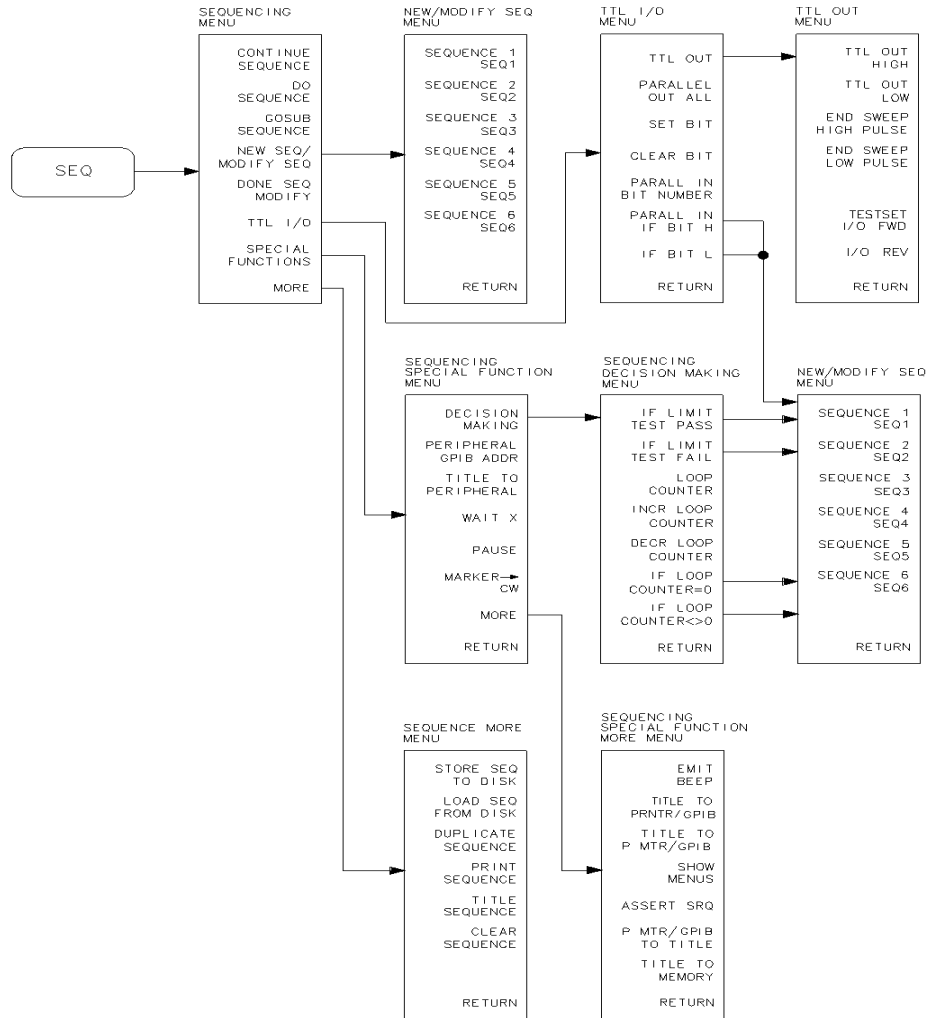
- 1 DOES NOT APPEAR DURING SEQUENCE MODIFICATION.
- 2 ONLY APPEARS DURING SEQUENCE MODIFICATION.

SAVE/RECALL menu map

Menu Maps
Menu Maps



SCALE REF menu map

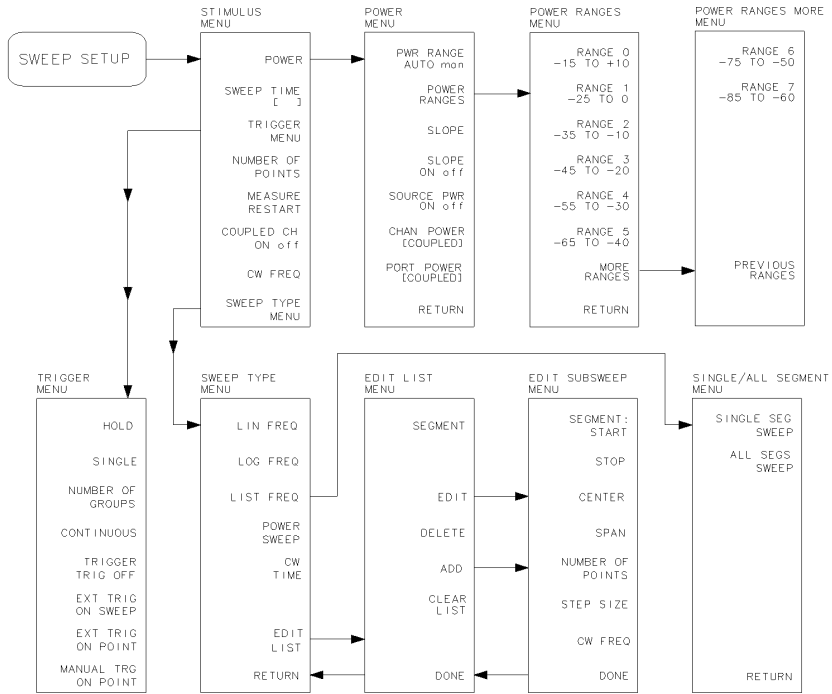


pg632d

SEQ menu map

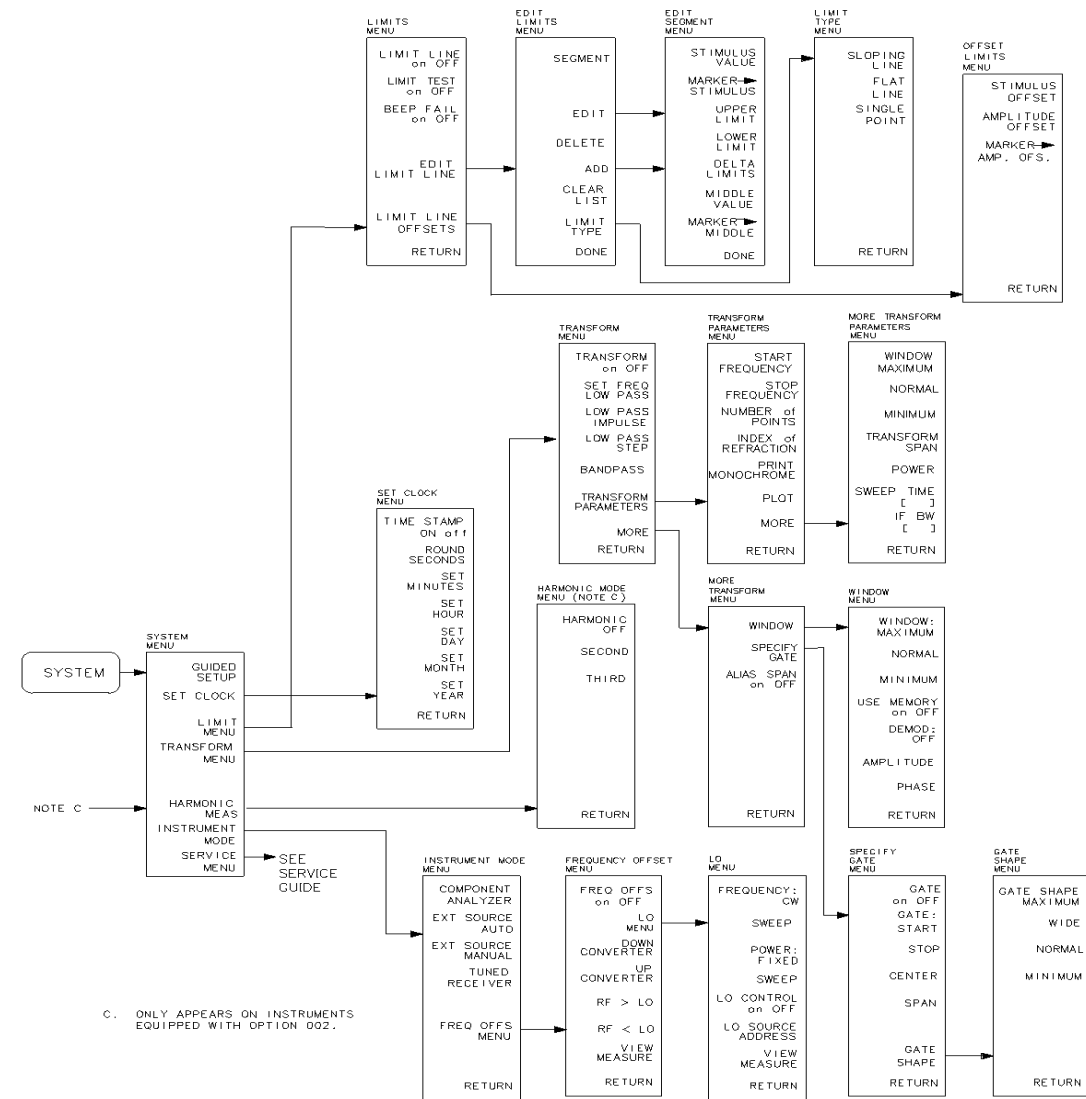
Menu Maps

Menu Maps



pg65d

SWEEP SETUP menu map



C. ONLY APPEARS ON INSTRUMENTS EQUIPPED WITH OPTION 002.

pg631d

SYSTEM menu map

Menu Maps

Menu Maps

Instrument Options	2-3
Available Accessories	2-5
Calibration Kits	2-5
Verification Kit	2-5
Test Port Return Cables	2-6
Adapter Kits	2-6
Transistor Test Fixtures	2-7
System Accessories Available	2-7
Power Cords	2-10
Front Panel Features	2-12
Analyzer Display	2-14
Rear Panel Features and Connectors	2-16
Unsupported Features	2-19
Reference Documents	2-20
General Measurement and Calibration Techniques	2-20
Fixtures and Non-coaxial Measurements	2-20
On-Wafer Measurements	2-21
Location of Softkeys	2-22
Connectors, Adjustments, and Display Annotation	2-40
Preset Conditions	2-43
Power-on Conditions	2-51

Reference

Reference

This chapter is a dictionary reference table of front and rear-panel connectors, front-panel keys (hardkeys), softkeys, and display annotations. With the exception of a few front-panel keys, softkeys control all instrument functions.

This chapter is designed for quick access of information. For example, during operation you may find a softkey or hardkey whose function is unfamiliar to you. Note the key name, find the key in this chapter, and note the applicable function. Some keys will have more than one function. Keys that begin with a symbol are listed at the front of the table.

Instrument Options

- Option 1D5** High Stability Frequency Reference. Option 1D5 offers ± 0.05 ppm temperature stability from 0 to 60°C (referenced to 25°C).
- Option 002** Harmonic Mode. Provides measurement of second or third harmonics of the test device's fundamental output signal. Frequency and power sweep are supported in this mode. Harmonic frequencies can be measured up to the maximum frequency of the receiver. However, the fundamental frequency may not be lower than 16 MHz.
- Option 006** Extends the maximum source and receiver frequency of the analyzer to 6 GHz.
- Option 011** Receiver Configuration. Option 011 allows front panel access to the R, A, and B samplers and receivers. The transfer switch, couplers, and bias tees have been removed. Therefore, external accessories are required to make most measurements.
- Option 075** 75 Ω Impedance. Option 075 offers 75 ohm impedance bridges with type-N test port connectors.
- Option 110** Deletes Time Domain. This option *removes* the time domain capability, which displays the time domain response of a network by computing the inverse Fourier transform of the frequency domain response. It shows the response of a test device as a function of time and distance. Displaying the reflection coefficient of a network versus time determines the magnitude and location of each discontinuity. Displaying the transmission coefficient of a network versus time determines the characteristics of individual transmission paths. Time domain operation retains all accuracy inherent with the correction that is active in the frequency domain. The time domain capability is useful for the design and characterization of such devices as SAW filters, SAW delay lines, RF cables, and RF antennas.

Instrument Options

Option 1CM

Rack Mount Flange Kit Without Handles. Option 1CM is a rack mount kit containing a pair of flanges and the necessary hardware to mount the instrument, with handles detached, in an equipment rack with 482.6 mm (19 inches) horizontal spacing.

Option 1CP

Rack Mount Flange Kit With Handles. Option 1CP is a rack mount kit containing a pair of flanges and the necessary hardware to mount the instrument with handles attached in an equipment rack with 482.6 mm (19 inches) spacing.

Available Accessories

Calibration Kits

The following calibration kits contain precision standards and required adapters of the indicated connector type. The standards (known devices) facilitate measurement calibration, also called vector error correction. Refer to the data sheet and ordering guide for additional information. Part numbers for the standards are in their manuals.

- Agilent 85031B 7 mm Calibration Kit
- Agilent 85032B 50 Ohm Type-N Calibration Kit
- Agilent 85033D 3.5 mm Calibration Kit
- Agilent 85036B 75 Ohm Type-N Calibration Kit
- Agilent 85039A 75 Ohm Type-F Calibration Kit

Verification Kit

Accurate operation of the analyzer system can be verified by measuring known devices other than the standards used in calibration, and comparing the results with recorded data.

Agilent 85029B 7 mm Verification Kit

This kit contains traceable precision 7 mm devices used to confirm the system's error-corrected measurement uncertainty performance. Also included is verification data on a 3.5 inch disk, together with a hard-copy listing. A system verification procedure is provided with this kit and is also located in the *Agilent 8702E Installation Guide*.

Test Port Return Cables

The following RF cables are used to connect a two-port device between the test ports. These cables provide shielding for high dynamic range measurements.

Agilent 11857D 7 mm Test Port Return Cable Set

This set consists of a pair of test port return cables that can be used in measurements of 7 mm devices. They can also be used with connectors other than 7 mm by using the appropriate precision adapters.

Agilent 11857B 75 Ohm Type-N Test Port Return Cable Set

This set consists of test port return cables for use with the Agilent 8702E Option 075.

Adapter Kits

Agilent 11852B 50 to 75 Ohm Minimum Loss Pad

This device converts impedance from 50 ohms to 75 ohms or from 75 ohms to 50 ohms. It is used to provide a low SWR impedance match between a 75 ohm device under test and the Agilent 8702E analyzer (without Option 075) or between the 50 Ω lightwave source and receiver and the Agilent 8702E Option 075.

Agilent 11853A 50 Ohm Type-N Adapter Kit

Agilent 11854A 50 Ohm BNC Adapter Kit

Agilent 11855A 75 Ohm Type-N Adapter Kit

Agilent 11856A 75 Ohm BNC Adapter Kit

These adapter kits contain the connection hardware required for making measurements on devices of the indicated connector type.

Transistor Test Fixtures

The following Agilent Technologies transistor test fixture is compatible with the Agilent 8702E. Additional test fixtures for transistors and other devices are available from Inter-Continental Microwave. To order their catalog, request Agilent Technologies literature number 5091-4254E, or contact Inter-Continental Microwave as follows:

1515 Wyatt Drive
Santa Clara, CA 95054-1524
(tel) 408 727-1596
(fax) 408 727-0105

Agilent 11608A Option 003 Transistor Fixture

This fixture is designed to be user-milled to hold stripline transistors for S-parameter measurements. Option 003 is pre-milled for 0.205 inch diameter disk packages, such as the HP¹ HPAC-200.

System Accessories Available

System Cabinet

The Agilent 85043D system cabinet is designed to rack mount the analyzer in a system configuration. The 132 cm (52 in) system cabinet includes a book-case, a drawer, and a convenient work surface.

Plotters and Printers

The analyzer is capable of plotting or printing displayed measurement results directly (without the use of an external computer) to a compatible peripheral. The analyzer supports GPIB, serial, and parallel peripherals. Most Hewlett-Packard desktop printers and plotters are compatible with the analyzer. Some common compatible peripherals are listed here (some are no longer available for purchase, but are listed here for your reference).

These plotters are compatible:

- HP 7440A ColorPro Eight-Pen Color Graphics Plotter
- HP 7470A Two-Pen Graphics Plotter
- HP 7475A Six-Pen Graphics Plotter
- HP 7550A/B High-Speed Eight-Pen Graphics Plotter

1. HP and Hewlett-Packard are registered trademarks of Hewlett-Packard Company.

Available Accessories

These printers are compatible:

- HP DeskJet 1200C (can also be used to plot)
- HP DeskJet 500
- HP C2170A, DeskJet 520
- HP DeskJet 500C
- HP DeskJet 540
- HP DeskJet 550C
- HP DeskJet 560C
- HP DeskJet 600, 660C, 682C, 690C, 850C, 870C, 1600C
- All LaserJets (LaserJet III and above can also be used to plot)
- HP C2621A DeskJet Portable InkJet
- PaintJet 3630A PaintJet Color Graphics Printer
- Epson printers which are compatible with the Epson ESC/P2 printer control language, such as the LQ570, are also supported by the analyzer. Older Epson printers, however, such as the FX-80, will not work with the analyzer.

Mass Storage

The analyzer has the capability of storing instrument states directly to its internal memory, to an internal disk, or to an external disk. The internal 3.5 inch floppy disk can be initialized in both LIF and DOS formats and is capable of reading and writing data in both formats. Using the internal disk drive is the preferred method, but all the capability of previous generation analyzers to use external disk drives still exists with the Agilent 8702E. Most external disks using CS80 protocol are compatible.

The analyzer does not support the LIF-HFS (hierarchy file system) directory format.

CAUTION

Do not use the older single-sided disks in the analyzer's internal drive.

GPIB Cables

A GPIB cable is required for interfacing the analyzer with a plotter, printer, external disk drive, or computer. The cables available are:

- Agilent 10833A GPIB Cable, 1.0 m (3.3 ft.)
- Agilent 10833B GPIB Cable, 2.0 m (6.6 ft.)
- Agilent 10833D GPIB Cable, 0.5 m (1.6 ft.)

Interface Cables

- HP C2951A Centronics (Parallel) Interface Cable, 3.0 m (9.9 ft.)
- HP C2913A RS-232C Interface Cable, 1.2 m (3.9 ft.)
- HP 24542G Serial Interface Cable, 3 m (9.9 ft.)
- HP C2950A Parallel Interface Cable, 2 m (6 ft.)

Keyboards



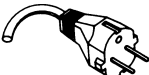


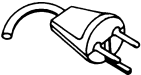
A keyboard can be connected to the analyzer for data input, such as titling files. The HP C1405B Option ABA keyboard, with the HP part number C1405-60015 adapter, is suitable for this purpose. Or, the analyzer is designed to accept most PC-AT-compatible keyboards with a standard DIN connector. Keyboards with a mini-DIN connector are compatible with the HP part number C1405-60015 adapter.

External Monitors The analyzer can drive both its internal display and an external monitor simultaneously. One compatible color monitor is the HP 35741A/B. (It is no longer available for purchase, but is listed here for your reference.)



External Monitor Requirements:

- 60 Hz vertical refresh rate
- 25.5 kHz horizontal refresh rate
- Standard VGA monitor

Power Cords

Plug Type	Cable Part No.	Plug Description	Length (in/cm)	Color	Country
	8120-1351	Straight *BS1363A	90/228	Gray	United Kingdom, Cyprus, Nigeria, Zimbabwe, Singapore
	8120-1703	90°	90/228	Mint Gray	
	8120-1369	Straight *NZSS198/ASC	79/200	Gray	Australia, New Zealand
	8120-0696	90°	87/221	Mint Gray	
	8120-1689	Straight *CEE7-Y11	79/200	Mint Gray	East and West Europe, Saudi Arabia, So. Africa, India (unpolarized in many nations)
	8120-1692	90°	79/200	Mint Gray	
	8120-2857p	Straight (Shielded)	79/200	Coco Brown	
	8120-1378	Straight *NEMA5-15P	90/228	Jade Gray	United States, Canada, Mexico, Philippines, Taiwan
	8120-1521	90°	90/228	Jade Gray	
	8120-1992	Straight (Medical) UL544	96/244	Black	
	8120-2104	Straight *SEV1011	79/200	Mint Gray	Switzerland
	8120-2296	1959-24507 Type 12 90°	79/200	Mint Gray	
	8120-2956	Straight *DHCK107	79/200	Mint Gray	Denmark
	8120-2957	90°	79/200	Mint Gray	

* Part number shown for plug is the industry identifier for the plug only. Number shown for cable is the Agilent Technologies part number for the complete cable including the plug.

Plug Type	Cable Part No.	Plug Description	Length (in/cm)	Color	Country
250V 	8120-4211	Straight SABS164	79/200	Jade Gray	Republic of South Africa
	8120-4600	90°	79/200		India
100V 	8120-4753	Straight MITI	90/230	Dark Gray	Japan
	8120-4754	90°	90/230		

* Part number shown for plug is the industry identifier for the plug only. Number shown for cable is the Agilent Technologies part number for the complete cable including the plug.

Front Panel Features

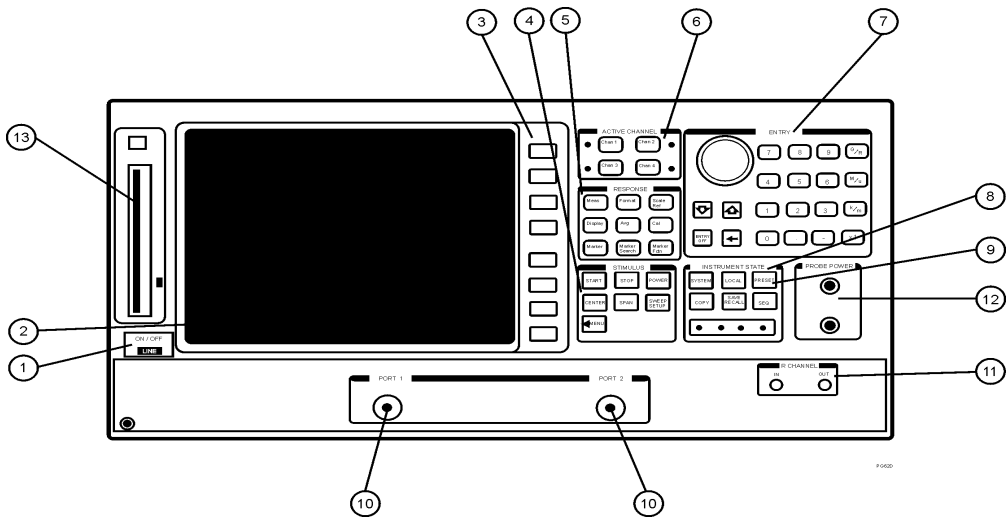


Figure 2-1. Agilent 8702E Front Panel

- 1** LINE switch. This switch controls ac power to the analyzer. 1 is on, 0 is off.
- 2** Display. This shows the measurement data traces, measurement annotation, and softkey labels. The display is divided into specific information areas, illustrated in [Figure 2-2](#).
- 3** Softkeys. These keys provide access to menus that are shown on the display.
- 4** STIMULUS function block. The keys in this block allow you to control the analyzer source's frequency, power, and other stimulus functions.
- 5** RESPONSE function block. The keys in this block allow you to control the measurement and display functions of the active display channel.
- 6** ACTIVE CHANNEL keys. The analyzer has four independent display channels.

These keys allow you to select the active channel, then any function entered will apply. Then any function you enter applies to this active channel.¹

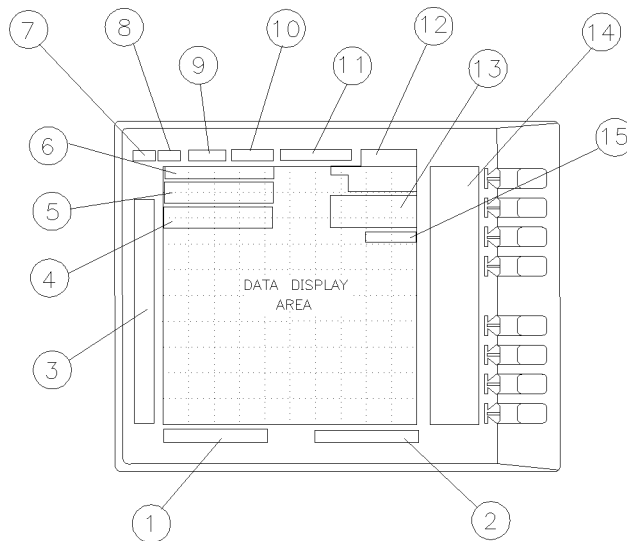
- 7** The ENTRY block. This block includes the knob, the step (\uparrow , \downarrow) keys, and the number pad. These allow you to enter numerical data and control the markers.
- 8** INSTRUMENT STATE function block. These keys allow you to control channel-independent system functions such as the following:
 - copying, save/recall, and GPIB controller mode
 - limit testing
 - external source mode
 - tuned receiver mode
 - frequency offset mode
 - test sequence function
 - harmonic measurements (Option 002)
 - time domain transform (Option 010)

GPIB STATUS indicators are also included in this block.

- 9** PRESET key. This key returns the instrument to either a known factory preset state or a user preset state that can be defined.
- 10** PORT 1 and PORT 2. These ports output a signal from the source and receive input signals from a device under test. PORT 1 allows you to measure S_{12} and S_{11} . PORT 2 allows you to measure S_{21} and S_{22} .
- 11** PROBE POWER connector. This connector (fused inside the instrument) supplies power to an active probe for in-circuit measurements of ac circuits.
- 12** R CHANNEL connectors. These connectors allow you to apply an input signal to the analyzer's R channel, for frequency offset mode.
- 13** Disk drive. This 3.5 inch drive allows you to store and recall instrument states and measurement results for later analysis.

1. Channels 3 and 4 are not functional selections with this model.

Analyzer Display



pg64d

Figure 2-2. Analyzer Display (Single Channel, Cartesian Format)

The analyzer display shows various measurement information:

- the grid where the analyzer plots the measurement data.
- the currently selected measurement parameters.
- the measurement data traces.

1 Stimulus Start Value. This value could be any one of the following:

- the start frequency of the source in frequency domain measurements.
- the start time in CW mode (0 seconds) or time domain measurements.
- the lowest power value in power sweep.

When the stimulus is in center/span mode, the center stimulus value is shown in this space.

2 Stimulus Stop Value. This value could be any one of the following:

- the stop frequency of the source in frequency domain measurements.
- the stop time in time domain measurements or CW sweeps.
- the upper limit of a power sweep.

When the stimulus is in center/span mode, the span is shown in this space. The stimulus values can be blanked.

3 Status Notations. This area shows the current status of various functions for the active channel.

4 Active Entry Area. This displays the active function and its current value.

5 Message Area. This displays prompts or error messages.

6 Title. This is a descriptive alphanumeric string title that you define and enter through an attached keyboard.

7 Active Channel. This is the number of the current active channel, selected with the ACTIVE CHANNEL keys. If dual channel is on with an overlaid display, both channel 1 and channel 2 appear in this area.

8 Measured Input(s). This shows the S-parameter, input, or ratio of inputs currently measured, as selected using the MEAS key. Also indicated in this area is the current display memory status.

9 Format. This is the display format that you selected using the FORMAT key.

10 Scale/Div. This is the scale that you selected using the SCALE/REF key, in units appropriate to the current measurement.

11 Reference Level. This value is the reference line in Cartesian formats or the outer circle in polar formats, whichever you selected using the SCALE/REF key. The reference level is also indicated by a small triangle adjacent to the graticule, at the left for channel 1 and at the right for channel 2.

12 Marker Values. These are the values of the active marker, in units appropriate to the current measurement.

13 Marker Stats, Bandwidth. These are statistical marker values that the analyzer calculates when you access the menus with the MKR FCTN key.

14 Softkey Labels. These menu labels redefine the function of the softkeys that are located to the right of the analyzer display.

15 Pass/Fail. During limit testing, the result will be annunciated as "PASS" if the limits are not exceeded, and "FAIL" if any points exceed the limits.

Rear Panel Features and Connectors

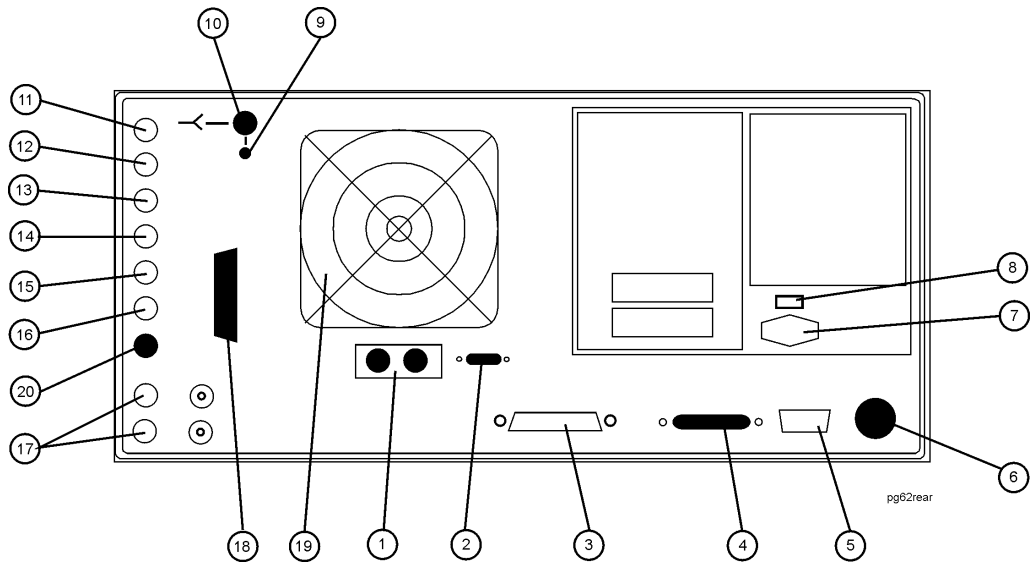


Figure 2-3. Agilent 8702E Rear Panel

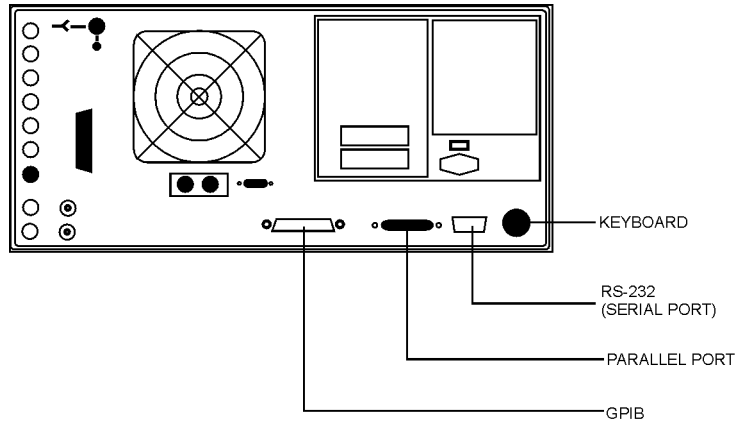
- 1** Serial number plate.
- 2** External Monitor. Standard VGA video output connector provides analog red, green, and blue video signals.
- 3** GPIB connector. This allows you to connect the analyzer to an external controller, compatible peripherals, and other instruments for an automated system.
- 4** PARALLEL connector. This connector allows the analyzer to output to a peripheral with a parallel input. Also included, is a general purpose input/output (GPIO) bus that can control eight output bits and read five input bits through test sequencing.
- 5** RS-232 connector. This connector allows the analyzer to output to a peripheral

with an RS-232 (serial) input.

- 6** KEYBOARD input (DIN) connector. This connector allows you to connect an external keyboard. This provides a more convenient means to enter a title for storage files, as well as a substitute for the analyzer's front panel keys. The keyboard must be connected to the analyzer before the power is switched on.
- 7** Power cord receptacle, with fuse.
- 8** Line voltage selector switch.
- 9** 10 MHZ REFERENCE ADJUST. (Option 1D5)
- 10** 10 MHZ PRECISION REFERENCE OUTPUT. (Option 1D5)
- 11** EXTERNAL REFERENCE INPUT connector. This allows for a frequency reference signal input that can phaselock the analyzer to an external frequency standard for increased frequency accuracy.
- 12** AUXILIARY INPUT connector. This allows for a dc or ac voltage input from an external signal source, such as a detector or function generator, which you can then measure using the S-parameter menu.
- 13** EXTERNAL AM connector. This allows for an external analog signal input that is applied to the ALC circuitry of the analyzer's source. This input analog signal amplitude modulates the RF output signal.
- 14** EXTERNAL TRIGGER connector. This allows connection of an external negative-going TTL-compatible signal that will trigger a measurement sweep. The trigger can be set to external through softkey functions.
- 15** TEST SEQUENCE. Outputs a TTL signal that can be programmed in a test sequence to be high or low, or pulse (10 μ seconds) high or low at the end of a sweep for robotic part handler interface.
- 16** LIMIT TEST. Outputs a TTL signal of the limit test results as follows:
 - Pass: TTL high
 - Fail: TTL low
- 17** BIAS INPUTS AND FUSES. These connector bias devices connected to port 1 and port 2. The fuses (1 A, 125 V) protect the port 1 and port 2 bias lines.
- 18** TEST SET INTERCONNECT. This allows you to connect an Agilent 8702E Option 011 analyzer to an Agilent 85046A/B or 85047A S-parameter test set using the interconnect cable supplied with the test set. The S-parameter test set is then fully controlled by the analyzer.
- 19** Fan.

Rear Panel Features and Connectors

20 Measurement Restart. This is port is not used.



qg612dr

Figure 2-4. Rear Panel Connectors

Unsupported Features

There are several new buttons on the Agilent 8702E front panel that are not supported. The following is a list of buttons that when depressed will indicate *Function Not Supported* on the LCD display.

- Channel 3
- Channel 4
- Return

Reference Documents

Hewlett-Packard Company, *Simplify Your Amplifier and Mixer Testing*, HP publication number 5956-4363

Hewlett-Packard Company, *RF and Microwave Device Test for the '90s - Seminar Papers*, HP publication number 5091-8804E

Hewlett-Packard Company, *Testing Amplifiers and Active Devices with the HP 8720 Network Analyzer*, Product Note 8720-1, HP publication number 5091-1942E

Hewlett-Packard Company, *Mixer Measurements using the HP 8753 Network Analyzer*, Product Note 8753-2A, HP publication number 5952-2771

General Measurement and Calibration Techniques

Blacka, Robert J., *TDR Gated Measurements of Stripline Terminations*, Reprint from *Microwave Product Digest*, HP publication number 5952-0359, March/April 1989

Montgomery, David, *Borrowing RF Techniques for Digital Design*, Reprint from *Computer Design*, HP publication number 5952-9335, May 1982

Rytting, Doug, *Advances in Microwave Error Correction Techniques*, Hewlett-Packard RF and Microwave Measurement Symposium paper, HP publication number 5954-8378, June 1987

Rytting, Doug, *Improved RF Hardware and Calibration Methods for Network Analyzers* Hewlett-Packard RF and Microwave Measurement Symposium paper, 1991

Fixtures and Non-coaxial Measurements

Hewlett-Packard Company, *Applying the HP 8510 TRL Calibration for Non-Coaxial Measurements*, Product Note 8510-8A, HP publication number 5091-3645E, February 1992

Hewlett-Packard Company, *Measuring Chip Capacitors with the HP 8520C Network Analyzers and Inter-Continental Microwave Test Fixtures*, Product Note 8510-17, HP publication number 5091-5674E, September 1992

Hewlett-Packard Company, *In-Fixture Microstrip Device Measurement Using TRL* Calibration*, Product Note 8720-2, HP publication number 5091-1943E, August 1991

Hewlett-Packard Company, *Calibration and Modeling Using the HP 83040 Modular Microcircuit Package*, Product Note 83040-2, HP publication number 5952-1907, May 1990

“Test Fixtures and Calibration Standards,” Inter-Continental Microwave Product Catalog, HP publication number 5091-4254E

Curran, Jim, *Network Analysis of Fixtured Devices*, Hewlett-Packard RF and Microwave Measurement Symposium paper, HP publication number 5954-8346, September 1986

Curran, Jim, *TRL Calibration for Non-Coaxial Measurements*, Hewlett-Packard Semiconductor Test Symposium paper

Elmore, Glenn and Louis Salz, “Quality Microwave Measurement of Packaged Active Devices,” *Hewlett-Packard Journal*, February 1987, *Measurement Techniques for Fixtured Devices*, HP 8510/8720 News, HP publication number 5952-2766, June 1990

On-Wafer Measurements

Hewlett-Packard Company, *On-Wafer Measurements Using the HP 8510 Network Analyzer and Cascade Microtech Wafer Probes*, Product Note 8510-6, HP publication number 5954-1579

Barr, J.T., T. Burcham, A.C. Davidson, E.W. Strid, *Advancements in On-Wafer Probing Calibration Techniques*, Hewlett-Packard RF and Microwave Measurement Symposium paper, 1991

Lautzenhiser, S., A. Davidson, D. Jones, *Improve Accuracy of On-Wafer Tests Via LRM Calibration*, Reprinting from *Microwaves and RF*, HP publication number 5952-1286, January 1990, *On-Wafer Calibration: Practical Considerations*, HP 8510/8720 News, HP publication number 5091-6837, February 1993

Location of Softkeys

Table 2-1. Location of Softkeys (1 of 18)

Softkey	Menu Location
Δ MODE MENU	Front-panel access key: MARKER
Δ MODE OFF	Front-panel access key: MARKER
Δ REF= 1	Front-panel access key: MARKER
Δ REF= 2	Front-panel access key: MARKER
Δ REF= 3	Front-panel access key: MARKER
Δ REF= 4	Front-panel access key: MARKER
Δ REF= 5	Front-panel access key: MARKER
Δ REF= Δ FIXED MKR	Front-panel access key: MARKER
1/S	Front-panel access key: MEAS
2.4 mm	Front-panel access key: CAL
2.92*	Front-panel access key: CAL
2.92 mm	Front-panel access key: CAL
3.5mmC	Front-panel access key: CAL
3.5mmD	Front-panel access key: CAL
7 mm	Front-panel access key: CAL
A	Front-panel access key: MEAS
A/B	Front-panel access key: MEAS
A/R	Front-panel access key: MEAS
ACTIVE ENTRY	Front-panel access key: DISPLAY
ACTIVE MKR MAGNITUDE	Front-panel access key: DISPLAY
ADD	Front-panel access key: CAL and MENU
ADDRESS: 8702	Front-panel access key: LOCAL
ADDRESS: CONTROLLER	Front-panel access key: LOCAL
ADDRESS: DISK	Front-panel access key: LOCAL
ADDRESS: DISK	Front-panel access key: SAVE/RECALL
ADDRESS: P MTR/GPIB	Front-panel access key: LOCAL
ADJUST DISPLAY	Front-panel access key: DISPLAY
ALIAS SPAN on OFF	Front-panel access key: SYSTEM

Table 2-1. Location of Softkeys (2 of 18)

Softkey	Menu Location
ALL OFF	Front-panel access key: MARKER
ALL SEGS SWEEP	Front-panel access key: SWEEP SETUP
ALTERNATE A AND B	Front-panel access key: CAL
AMPLITUDE	Front-panel access key: SYSTEM
AMPLITUDE OFFSET	Front-panel access key: SYSTEM
ANALOG IN Aux Input	Front-panel access key: MEAS
ARBITRARY IMPEDANCE	Front-panel access key: CAL
ASCII	Front-panel access key: SAVE/RECALL
ASSERT SRQ	Front-panel access key: SEQ
AUTO-FEED ON off	Front-panel access key: COPY
AUTO SCALE	Front-panel access key: SCALE REF
AVERAGING FACTOR	Front-panel access key: AVG
AVERAGING on OFF	Front-panel access key: AVG
AVERAGING RESTART	Front-panel access key: AVG
B	Front-panel access key: MEAS
B/R	Front-panel access key: MEAS
BACKGROUND INTENSITY	Front-panel access key: DISPLAY
BACKSPACE	Front-panel access key: CAL
BANDPASS	Front-panel access key: SYSTEM
BEEP DONE ON off	Front-panel access key: DISPLAY
BEEP FAIL on OFF	Front-panel access key: SYSTEM
BEEP WARN on OFF	Front-panel access key: DISPLAY
BLANK DISPLAY	Front-panel access key: DISPLAY
BRIGHTNESS	Front-panel access key: DISPLAY
C0	Front-panel access key: CAL
C1	Front-panel access key: CAL
C2	Front-panel access key: CAL
C3	Front-panel access key: CAL
CAL FACTOR	Front-panel access key: CAL
CAL FACTOR SENSOR A	Front-panel access key: CAL
CAL FACTOR SENSOR B	Front-panel access key: CAL
CAL KITS & STDS	Front-panel access key: CAL
CAL KIT: 2.4 mm	Front-panel access key: CAL
CAL KIT: 2.92*	Front-panel access key: CAL
CAL KIT: 2.92 mm	Front-panel access key: CAL
CAL KIT: 3.5mmC	Front-panel access key: CAL

Location of Softkeys**Table 2-1. Location of Softkeys (3 of 18)**

Softkey	Menu Location
CAL KIT: 3.5mmD	Front-panel access key: CAL
CAL KIT: 7mm	Front-panel access key: CAL
CAL KIT: N 50Ω	Front-panel access key: CAL
CAL KIT: N 75Ω	Front-panel access key: CAL
CAL KIT: TRL 3.5 mm	Front-panel access key: CAL
CALIBRATE MENU	Front-panel access key: CAL
CALIBRATE: NONE	Front-panel access key: CAL
CAL Z0 LINE Z0	Front-panel access key: CAL
CENTER	Front-panel access key: SWEEP SETUP
CENTER	Front-panel access key: SYSTEM
CH1 DATA []	Front-panel access key: COPY
CH1 DATA LIMIT LN	Front-panel access key: DISPLAY
CH1 MEM	Front-panel access key: DISPLAY
CH1 MEM []	Front-panel access key: COPY
CH2 DATA []	Front-panel access key: COPY
CH2 DATA LIMIT LN	Front-panel access key: DISPLAY
CH2 MEM []	Front-panel access key: COPY
CH2 MEM REF LINE	Front-panel access key: DISPLAY
CHAN POWER [COUPLED uncoupled]	Front-panel access key: SWEEP SETUP
CHOP A AND B	Front-panel access key: CAL
CLEAR BIT	Front-panel access key: SEQ
CLEAR LIST	Front-panel access key: CAL and SWEEP SETUP
CLEAR SEQUENCE	Front-panel access key: SEQ
COAX	Front-panel access key: CAL
COAXIAL DELAY	Front-panel access key: SCALE REF
COLOR	Front-panel access key: DISPLAY
COMPONENT ANALYZER	Front-panel access key: SYSTEM
CONFIGURE EXT DISK	Front-panel access key: SAVE/RECALL
CONTINUE SEQUENCE	Front-panel access key: SEQ
CONTINUOUS	Front-panel access key: SWEEP SETUP and MARKER FCTN
CONVERSION []	Front-panel access key: MEAS
CORRECTION on OFF	Front-panel access key: CAL
COUPLED	Front-panel access key: MARKER FCTN
COUPLED CH ON off	Front-panel access key: SWEEP SETUP
CW FREQ	Front-panel access key: SWEEP SETUP
CW TIME	Front-panel access key: SWEEP SETUP

Table 2-1. Location of Softkeys (4 of 18)

Softkey	Menu Location
D2/D1 TO D2 on OFF	Front-panel access key: DISPLAY
DATA AND MEMORY	Front-panel access key: DISPLAY
DATA ARRAY on off	Front-panel access key: SAVE/RECALL
DATA/MEM	Front-panel access key: DISPLAY
DATA – MEM	Front-panel access key: DISPLAY
DATA → MEMORY	Front-panel access key: DISPLAY
DATA ONLY on off	Front-panel access key: SAVE/RECALL
DECISION MAKING	Front-panel access key: SEQ
DECR LOOP COUNTER	Front-panel access key: SEQ
DEFAULT COLORS	Front-panel access key: DISPLAY
DEFAULT PLOT SETUP	Front-panel access key: COPY
DEFAULT PRNT SETUP	Front-panel access key: COPY
DEFAULT RCVR COEFF	Front-panel access key: CAL
DEFAULT SRC COEFF	Front-panel access key: CAL
DEFAULT STANDARDS	Front-panel access key: CAL
DEFINE DISK-SAVE	Front-panel access key: SAVE/RECALL
DEFINE PLOT	Front-panel access key: COPY
DEFINE PRINT	Front-panel access key: COPY
DEFINE STANDARD	Front-panel access key: CAL
DELAY	Front-panel access key: FORMAT
DELAY/THRU	Front-panel access key: CAL
DELETE	Front-panel access key: CAL, SWEEP SETUP and SYSTEM
DELETE ALL FILES	Front-panel access key: SAVE/RECALL
DELETE FILE	Front-panel access key: SAVE/RECALL
DELTA LIMITS	Front-panel access key: SYSTEM
DEMOD: OFF	Front-panel access key: SYSTEM
DIRECTORY SIZE (LIF)	Front-panel access key: SAVE/RECALL
DISCRETE	Front-panel access key: MARKER FCTN
DISK	Front-panel access key: LOCAL
DISK UNIT NUMBER	Front-panel access key: SAVE/RECALL
DISPLAY: DATA	Front-panel access key: DISPLAY
DISP MKRS ON off	Front-panel access key: MARKER FCTN
DO BOTH FWD + REV	Front-panel access key: CAL
DONE 1-PORT CAL	Front-panel access key: CAL
DONE 2-PORT CAL	Front-panel access key: CAL
DONE LINE/MATCH	Front-panel access key: CAL

Location of Softkeys**Table 2-1. Location of Softkeys (5 of 18)**

Softkey	Menu Location
DONE RESPONSE	Front-panel access key: CAL
DONE RESP ISOL'N CAL	Front-panel access key: CAL
DONE SEQ MODIFY	Front-panel access key: SEQ
DONE TRL/LRM	Front-panel access key: CAL
DO SEQUENCE	Front-panel access key: SEQ
DOS	Front-panel access key: SAVE/RECALL
DOWN CONVERTER	Front-panel access key: SYSTEM
DUAL CHAN on OFF	Front-panel access key: DISPLAY
DUPLICATE SEQUENCE	Front-panel access key: SEQ
EACH SWEEP	Front-panel access key: CAL
EDIT	Front-panel access key: CAL, SWEEP SETUP and SYSTEM
EDIT LIMIT LINE	Front-panel access key: SYSTEM
EDIT LIST	Front-panel access key: SWEEP SETUP
ELECTRICAL DELAY	Front-panel access key: SCALE REF
EMIT BEEP	Front-panel access key: SEQ
END OF LABEL	Front-panel access key: DISPLAY
END SWEEP HIGH PULSE	Front-panel access key: SEQ
END SWEEP LOW PULSE	Front-panel access key: SEQ
ENTER RCVR COEFF MENU	Front-panel access key: CAL
ENTER SRC COEFF MENU	Front-panel access key: CAL
ERASE TITLE	Front-panel access key: DISPLAY
EXT SOURCE AUTO	Front-panel access key: SYSTEM
EXT SOURCE MANUAL	Front-panel access key: SYSTEM
EXT TRIG ON POINT	Front-panel access key: SWEEP SETUP
EXT TRIG ON SWEEP	Front-panel access key: SWEEP SETUP
EXTENSION INPUT A	Front-panel access key: CAL
EXTENSION INPUT B	Front-panel access key: CAL
EXTENSION PORT 1	Front-panel access key: CAL
EXTENSION PORT 2	Front-panel access key: CAL
EXTENSIONS on OFF	Front-panel access key: CAL
EXTERNAL DISK	Front-panel access key: SAVE/RECALL
FACTORY	Front-panel access key: PRESET
FILE UTILITIES	Front-panel access key: SAVE/RECALL
FIXED	Front-panel access key: CAL
FIXED MKR AUX VALUE	Front-panel access key: MARKER
FIXED MKR POSITION	Front-panel access key: MARKER

Table 2-1. Location of Softkeys (6 of 18)

Softkey	Menu Location
FIXED MKR STIMULUS	Front-panel access key: MARKER
FIXED MKR VALUE	Front-panel access key: MARKER
FLAT LINE	Front-panel access key: SYSTEM
FORM FEED	Front-panel access key: DISPLAY
FORMAT ARY on off	Front-panel access key: SAVE/RECALL
FORMAT DISK	Front-panel access key: SAVE/RECALL
FORMAT: DOS	Front-panel access key: SAVE/RECALL
FORMAT EXT DISK	Front-panel access key: SAVE/RECALL
FORMAT INT DISK	Front-panel access key: SAVE/RECALL
FORMAT INT MEMORY	Front-panel access key: SAVE/RECALL
FORMAT: LIF	Front-panel access key: SAVE/RECALL
FORWARD:	Front-panel access key: CAL
FREQ OFFS MENU	Front-panel access key: SYSTEM
FREQ OFFS on OFF	Front-panel access key: SYSTEM
FREQUENCY	Front-panel access key: CAL
FREQUENCY BLANK	Front-panel access key: DISPLAY
FREQUENCY: CW	Front-panel access key: SYSTEM
FREQUENCY: SWEEP	Front-panel access key: SYSTEM
FULL 2-PORT	Front-panel access key: CAL
FULL PAGE	Front-panel access key: COPY
FWD ISOL'N ISOL'N STD	Front-panel access key: CAL
FWD MATCH	Front-panel access key: CAL
FWD MATCH THRU	Front-panel access key: CAL
FWD TRANS	Front-panel access key: CAL
FWD TRANS THRU	Front-panel access key: CAL
G+jB MKR	Front-panel access key: MARKER FCTN
GATE: CENTER	Front-panel access key: SYSTEM
GATE on OFF	Front-panel access key: SYSTEM
GATE SHAPE	Front-panel access key: SYSTEM
GATE SHAPE MAXIMUM	Front-panel access key: SYSTEM
GATE SHAPE MINIMUM	Front-panel access key: SYSTEM
GATE SHAPE NORMAL	Front-panel access key: SYSTEM
GATE SHAPE WIDE	Front-panel access key: SYSTEM
GATE: SPAN	Front-panel access key: SYSTEM
GATE: START	Front-panel access key: SYSTEM
GATE: STOP	Front-panel access key: SYSTEM

Location of Softkeys**Table 2-1. Location of Softkeys (7 of 18)**

Softkey	Menu Location
GOSUB SEQUENCE	Front-panel access key: SEQ
GRAPHICS on off	Front-panel access key: SAVE/RECALL
GRATICULE []	Front-panel access key: COPY
GRATICULE TEXT	Front-panel access key: DISPLAY
GUIDED SETUP	Front-panel access key: PRESET and SYSTEM
HARMONIC MEAS	Front-panel access key: SYSTEM
HARMONIC OFF	Front-panel access key: SYSTEM
HARMONIC SECOND	Front-panel access key: SYSTEM
HARMONIC THIRD	Front-panel access key: SYSTEM
HOLD	Front-panel access key: SWEEP SETUP
GP-IB DIAG on OFF	Front-panel access key: LOCAL
I/O FWD	Front-panel access key: SEQ
I/O REV	Front-panel access key: SEQ
IF BIT H	Front-panel access key: SEQ
IF BIT L	Front-panel access key: SEQ
IF BW []	Front-panel access key: AVG and SYSTEM
IF LIMIT TEST FAIL	Front-panel access key: SEQ
IF LIMIT TEST PASS	Front-panel access key: SEQ
IF LOOP COUNTER=0	Front-panel access key: SEQ
IF LOOP COUNTER < > 0	Front-panel access key: SEQ
IMAGINARY	Front-panel access key: FORMAT
INCR LOOP COUNTER	Front-panel access key: SEQ
INDEX of REFRACTION	Front-panel access key: CAL and SYSTEM
INPUT PORT CAL	Front-panel access key: CAL
INPUT PORTS	Front-panel access key: MEAS
INSTRUMENT MODE	Front-panel access key: SYSTEM
INTENSITY	Front-panel access key: DISPLAY
INTERNAL DISK	Front-panel access key: SAVE/RECALL
INTERNAL MEMORY	Front-panel access key: SAVE/RECALL
INTERPOL on OFF	Front-panel access key: CAL
1/S	Front-panel access key: MEAS
ISOLATION	Front-panel access key: CAL
ISOLATION DONE	Front-panel access key: CAL
ISOL'N STD	Front-panel access key: CAL
ISTATE CONTENTS	Front-panel access key: SAVE/RECALL
KIT DONE (MODIFIED)	Front-panel access key: CAL

Table 2-1. Location of Softkeys (8 of 18)

Softkey	Menu Location
LABEL CLASS	Front-panel access key: CAL
LABEL CLASS DONE	Front-panel access key: CAL
LABEL KIT	Front-panel access key: CAL
LABEL STD	Front-panel access key: CAL
LEFT LOWER	Front-panel access key: COPY
LEFT UPPER	Front-panel access key: COPY
LIF	Front-panel access key: SAVE/RECALL
LIGHTWAVE PARAMETERS	Front-panel access key: MEAS
LIMIT LINE OFFSETS	Front-panel access key: SYSTEM
LIMIT LINE on OFF	Front-panel access key: SYSTEM
LIMIT MENU	Front-panel access key: SYSTEM
LIMIT TEST on OFF	Front-panel access key: SYSTEM
LIMIT TEST RESULT	Front-panel access key: DISPLAY
LIMIT TYPE	Front-panel access key: SYSTEM
LINE/MATCH	Front-panel access key: CAL
LIN FREQ	Front-panel access key: SWEEP SETUP
LIN MAG	Front-panel access key: FORMAT
LIN MKR	Front-panel access key: MARKER FCTN
LINE/MATCH	Front-panel access key: CAL
LINE Z0:	Front-panel access key: CAL
LINE TYPE DATA	Front-panel access key: COPY
LINE TYPE MEMORY	Front-panel access key: COPY
LIST	Front-panel access key: COPY
LIST FREQ	Front-panel access key: SWEEP SETUP
LIST VALUES	Front-panel access key: COPY
LN/MATCH 1 LOAD	Front-panel access key: CAL
LN/MATCH 2 LOAD	Front-panel access key: CAL
LO CONTROL on OFF	Front-panel access key: SYSTEM
LO MENU	Front-panel access key: SYSTEM
LO SOURCE ADDRESS	Front-panel access key: SYSTEM
LOAD	Front-panel access key: CAL
LOAD RCVR DISK MENU	Front-panel access key: CAL
LOAD SEQ FROM DISK	Front-panel access key: SEQ
LOAD SRC DISK MENU	Front-panel access key: CAL
LOG FREQ	Front-panel access key: SWEEP SETUP
LOG MAG	Front-panel access key: FORMAT

Location of Softkeys**Table 2-1. Location of Softkeys (9 of 18)**

Softkey	Menu Location
LOG MKR	Front-panel access key: MARKER FCTN
LOOP COUNTER	Front-panel access key: DISPLAY and SEQ
LOSS	Front-panel access key: CAL
LOSS/SENSR LISTS	Front-panel access key: CAL
LOWER LIMIT	Front-panel access key: SYSTEM
LOW PASS IMPULSE	Front-panel access key: SYSTEM
LOW PASS STEP	Front-panel access key: SYSTEM
MANUAL TRG ON POINT	Front-panel access key: SWEEP SETUP
MARKER → AMP. OFS.	Front-panel access key: SYSTEM
MARKER → CENTER	Front-panel access key: MARKER FCTN
MARKER → CW	Front-panel access key: SEQ
MARKER → DELAY	Front-panel access key: MARKER FCTN
MARKER → MIDDLE	Front-panel access key: SYSTEM
MARKER → REFERENCE	Front-panel access key: MARKER FCTN and SCALE REF
MARKER → SPAN	Front-panel access key: MARKER FCTN
MARKER → START	Front-panel access key: MARKER FCTN
MARKER → STIMULUS	Front-panel access key: SYSTEM
MARKER → STOP	Front-panel access key: MARKER FCTN
MARKER 1, 2, 3, 4, and 5	Front-panel access key: MARKER
MARKER MODE MENU	Front-panel access key: MARKER FCTN
MARKERS: CONTINUOUS	Front-panel access key: MARKER FCTN
MARKERS: COUPLED	Front-panel access key: MARKER FCTN
MARKERS: DISCRETE	Front-panel access key: MARKER FCTN
MARKERS: UNCOUPLED	Front-panel access key: MARKER FCTN
MAX	Front-panel access key: MARKER FCTN and SRCH
MAXIMUM FREQUENCY	Front-panel access key: CAL
MEASURE RESTART	Front-panel access key: SWEEP SETUP
MEMORY	Front-panel access key: DISPLAY
MIDDLE VALUE	Front-panel access key: SYSTEM
MIN	Front-panel access key: MARKER FCTN and SRCH
MINIMUM FREQUENCY	Front-panel access key: CAL
MKR SEARCH []	Front-panel access key: MARKER FCTN and SRCH
MKR ZERO	Front-panel access key: MARKER
MODIFY []	Front-panel access key: CAL
MODIFY COLORS	Front-panel access key: DISPLAY

Table 2-1. Location of Softkeys (10 of 18)

Softkey	Menu Location
MODIFY STANDARDS	Front-panel access key: CAL
MODIFY THRU/RCVR	Front-panel access key: CAL
N 50Ω	Front-panel access key: CAL
N 75Ω	Front-panel access key: CAL
NEW SEQ/MODIFY SEQ	Front-panel access key: SEQ
NEWLINE	Front-panel access key: DISPLAY
NUMBER OF GROUPS	Front-panel access key: SWEEP SETUP
NUMBER OF POINTS	Front-panel access key: SYSTEM
NUMBER OF READINGS	Front-panel access key: CAL
OFFSET DELAY	Front-panel access key: CAL
OFFSET LOSS	Front-panel access key: CAL
OFFSET Z0	Front-panel access key: CAL
OMIT ISOLATION	Front-panel access key: CAL
ONE-PATH 2-PORT	Front-panel access key: CAL
ONE SWEEP	Front-panel access key: CAL
OP PARMS (MKRS etc.)	Front-panel access key: COPY
OPEN	Front-panel access key: CAL
OPTICAL STANDARDS	Front-panel access key: CAL
P MTR/GPIB TO TITLE	Front-panel access key: SEQ
NEXT PAGE	Front-panel access key: COPY
PARALLEL	Front-panel access key: LOCAL
PARALLEL []	Front-panel access key: LOCAL
PARALLEL OUT ALL	Front-panel access key: SEQ
PARALL IN BIT NUMBER	Front-panel access key: SEQ
PARALL IN IF BIT H	Front-panel access key: SEQ
PARALL IN IF BIT L	Front-panel access key: SEQ
PAUSE	Front-panel access key: SEQ
PEN NUM DATA	Front-panel access key: COPY
PEN NUM GRATICULE	Front-panel access key: COPY
PEN NUM MARKER	Front-panel access key: COPY
PEN NUM MEMORY	Front-panel access key: COPY
PEN NUM TEXT	Front-panel access key: COPY
PERIPHERAL GPIB ADDR	Front-panel access key: SEQ
PHASE	Front-panel access key: FORMAT and SYSTEM
PHASE OFFSET	Front-panel access key: SCALE REF
PLOT	Front-panel access key: COPY and SYSTEM

Location of Softkeys**Table 2-1. Location of Softkeys (11 of 18)**

Softkey	Menu Location
PLOT DATA ON off	Front-panel access key: COPY
PLOT GRAT ON off	Front-panel access key: COPY
PLOT MEM ON off	Front-panel access key: COPY
PLOT MKR ON off	Front-panel access key: COPY
PLOT SPEED []	Front-panel access key: COPY
PLOT TEXT ON off	Front-panel access key: COPY
PLOTTER BAUD RATE	Front-panel access key: LOCAL
PLOTTER FORM FEED	Front-panel access key: COPY
PLOTTER PORT	Front-panel access key: LOCAL
PLTR PORT GPIB	Front-panel access key: LOCAL
PLTR TYPE []	Front-panel access key: LOCAL
POLAR	Front-panel access key: FORMAT
POLAR MKR MENU	Front-panel access key: MARKER FCTN
PORT EXTENSIONS	Front-panel access key: CAL
PORT POWER [COUPLED uncoupled]	Front-panel access key: SWEEP SETUP and PWR
POWER	Front-panel access key: SWEEP SETUP, SYSTEM and PWR
POWER: FIXED	Front-panel access key: SYSTEM
POWER LOSS	Front-panel access key: CAL
POWER MTR: []	Front-panel access key: LOCAL
POWER RANGES	Front-panel access key: SWEEP SETUP and PWR
POWER: SWEEP	Front-panel access key: SWEEP SETUP and PWR
PRESET: FACTORY	Front-panel access key: PRESET
PRESET: USER	Front-panel access key: PRESET
PRINT: COLOR	Front-panel access key: COPY
PRINT COLORS	Front-panel access key: COPY
PRINT: MONOCHROME	Front-panel access key: COPY
PRINT ALL MONOCHROME	Front-panel access key: COPY
PRINT MONOCHROME	Front-panel access key: COPY and SYSTEM
PRINT SEQUENCE	Front-panel access key: SEQ
PRINTER BAUD RATE	Front-panel access key: LOCAL
PRINTER FORM FEED	Front-panel access key: COPY
PRINTER PORT	Front-panel access key: LOCAL
PRNTR PORT GPIB	Front-panel access key: LOCAL
PRNTR TYPE []	Front-panel access key: LOCAL
PWR LOSS on OFF	Front-panel access key: CAL
PWR RANGE AUTO man	Front-panel access key: MENU and PWR

Table 2-1. Location of Softkeys (12 of 18)

Softkey	Menu Location
PWRMTR CAL []	Front-panel access key: CAL
PWRMTR CAL OFF	Front-panel access key: CAL
R	Front-panel access key: MEAS
R+jX MKR	Front-panel access key: MARKER FCTN
RANGE 0 –15 TO +10	Front-panel access key: SWEEP SETUP and PWR
RANGE 1 –25 TO 0	Front-panel access key: SWEEP SETUP and PWR
RANGE 2 –35 TO –10	Front-panel access key: SWEEP SETUP and PWR
RANGE 3 –45 TO –20	Front-panel access key: SWEEP SETUP and PWR
RANGE 4 –55 TO –30	Front-panel access key: SWEEP SETUP and PWR
RANGE 5 –65 TO –40	Front-panel access key: SWEEP SETUP and PWR
RANGE 6 –75 TO –50	Front-panel access key: SWEEP SETUP and PWR
RANGE 7 –85 TO –60	Front-panel access key: SWEEP SETUP and PWR
RAW ARRAY on/off	Front-panel access key: SAVE/RECALL
Re/Im MKR	Front-panel access key: MARKER FCTN
REAL	Front-panel access key: FORMAT
RECALL COLORS	Front-panel access key: DISPLAY
RECALL KEYS MENU	Front-panel access key: SAVE/RECALL
RECALL KEYS ON/OFF	Front-panel access key: SAVE/RECALL
RECALL REG1 – 7	Front-panel access key: SAVE/RECALL
RECALL STATE	Front-panel access key: SAVE/RECALL
RECEIVER STANDARDS	Front-panel access key: CAL
REFERENCE POSITION	Front-panel access key: SCALE REF
REFERENCE VALUE	Front-panel access key: SCALE REF
Refl: E S11 FWD	Front-panel access key: MEAS
Refl: E S22 (B/R)	Front-panel access key: MEAS
Refl: E S22 REV	Front-panel access key: MEAS
Refl: O (PORT 1→2)	Front-panel access key: MEAS
REFLECT	Front-panel access key: CAL
REFLECT'N	Front-panel access key: CAL
RENAME FILE	Front-panel access key: SAVE/RECALL
RE-SAVE STATE	Front-panel access key: SAVE/RECALL
RESET COLOR	Front-panel access key: DISPLAY
RESPONSE	Front-panel access key: CAL
RESPONSE & ISOL'N	Front-panel access key: CAL
RESPONSE & MATCH	Front-panel access key: CAL
RESTORE DISPLAY	Front-panel access key: COPY

Location of Softkeys**Table 2-1. Location of Softkeys (13 of 18)**

Softkey	Menu Location
RESUME CAL SEQUENCE	Front-panel access key: CAL
REV ISOL'N ISOL'N STD	Front-panel access key: CAL
REV MATCH	Front-panel access key: CAL
REV MATCH THRU	Front-panel access key: CAL
REV TRANS	Front-panel access key: CAL
REV TRANS THRU	Front-panel access key: CAL
REVERSE:	Front-panel access key: CAL
RF > LO	Front-panel access key: SYSTEM
RF < LO	Front-panel access key: SYSTEM
RIGHT LOWER	Front-panel access key: COPY
RIGHT UPPER	Front-panel access key: COPY
ROUND SECONDS	Front-panel access key: SYSTEM
S11 1-PORT	Front-panel access key: CAL
S11 REFL OPEN	Front-panel access key: CAL
S11A	Front-panel access key: CAL
S11B	Front-panel access key: CAL
S11C	Front-panel access key: CAL
S22 1-PORT	Front-panel access key: CAL
S22 REFL OPEN	Front-panel access key: CAL
S22A	Front-panel access key: CAL
S22B	Front-panel access key: CAL
S22C	Front-panel access key: CAL
SAVE/RECALL MENU	Front-panel access key: SAVE/RECALL
SAVE COLORS	Front-panel access key: DISPLAY
SAVE RCVR COEFF	Front-panel access key: CAL
SAVE SRC COEFF	Front-panel access key: CAL
SAVE STANDARDS	Front-panel access key: CAL
SAVE STATE	Front-panel access key: SAVE/RECALL
SAVE USER KIT	Front-panel access key: CAL
SAVE USING BINARY	Front-panel access key: SAVE/RECALL
SCALE/DIV	Front-panel access key: SCALE REF
SCALE PLOT []	Front-panel access key: COPY
SEARCH LEFT	Front-panel access key: MARKER FCTN and SRCH
SEARCH: MAX	Front-panel access key: MARKER FCTN and SRCH
SEARCH: MIN	Front-panel access key: MARKER FCTN and SRCH
SEARCH: OFF	Front-panel access key: MARKER FCTN and SRCH

Table 2-1. Location of Softkeys (14 of 18)

Softkey	Menu Location
SEARCH RIGHT	Front-panel access key: MARKER FCTN and SRCH
SECOND	Front-panel access key: SYSTEM
SEGMENT	Front-panel access key: CAL, SWEEP SETUP and SYSTEM
SEGMENT: CENTER	Front-panel access key: SWEEP SETUP
SEGMENT: SPAN	Front-panel access key: SWEEP SETUP
SEGMENT: START	Front-panel access key: SWEEP SETUP
SEGMENT: STOP	Front-panel access key: SWEEP SETUP
SEL QUAD []	Front-panel access key: COPY
SELECT CAL KEY	Front-panel access key: CAL
SELECT CAL KIT	Front-panel access key: CAL
SELECT DISK	Front-panel access key: SAVE/RECALL
SELECT LETTER	Front-panel access key: CAL, DISPLAY and SAVE/RECALL
SEQUENCE 1 SEQ1	Front-panel access key: SEQ
SEQUENCE 2 SEQ2	Front-panel access key: SEQ
SEQUENCE 3 SEQ3	Front-panel access key: SEQ
SEQUENCE 4 SEQ4	Front-panel access key: SEQ
SEQUENCE 5 SEQ5	Front-panel access key: SEQ
SEQUENCE 6 SEQ6	Front-panel access key: SEQ
SERIAL	Front-panel access key: LOCAL
SERVICE MENU	Front-panel access key: SYSTEM
SET ADDRESSES	Front-panel access key: LOCAL
SET BIT	Front-panel access key: SEQ
SET CLOCK	Front-panel access key: SYSTEM
SET DAY	Front-panel access key: SYSTEM
SET FREQ LOW PASS	Front-panel access key: SYSTEM
SET HOUR	Front-panel access key: SYSTEM
SET MINUTES	Front-panel access key: SYSTEM
SET MONTH	Front-panel access key: SYSTEM
SET REF	Front-panel access key: CAL
SET YEAR	Front-panel access key: SYSTEM
SET Z0	Front-panel access key: CAL
SHORT	Front-panel access key: CAL
SINGLE	Front-panel access key: SWEEP SETUP
SINGLE POINT	Front-panel access key: SYSTEM
SINGLE SEG SWEEP	Front-panel access key: SWEEP SETUP
SLIDING OFFSET	Front-panel access key: CAL

Location of Softkeys**Table 2-1. Location of Softkeys (15 of 18)**

Softkey	Menu Location
SLOPE	Front-panel access key: SWEEP SETUP
SLOPE ON off	Front-panel access key: SWEEP SETUP
SLOPING LINE	Front-panel access key: SYSTEM
SMITH CHART	Front-panel access key: FORMAT
SMITH MKR MENU	Front-panel access key: MARKER FCTN
SMOOTHING APERTURE	Front-panel access key: AVG
SMOOTHING on OFF	Front-panel access key: AVG
SOURCE PWR ON off	Front-panel access key: SWEEP SETUP and PWR
SOURCE STANDARDS	Front-panel access key: CAL
SPAN	Front-panel access key: SWEEP SETUP
SPAN	Front-panel access key: SYSTEM
S PARAMETERS	Front-panel access key: MEAS
SPECIAL FUNCTIONS	Front-panel access key: SEQ
SPECIFY CLASS	Front-panel access key: CAL
SPECIFY CLASS DONE	Front-panel access key: CAL
SPECIFY GATE	Front-panel access key: SYSTEM
SPECIFY OFFSET	Front-panel access key: CAL
SPECIFY TRL THRU	Front-panel access key: CAL
SPLIT DISP ON off	Front-panel access key: DISPLAY
STANDARDS DONE	Front-panel access key: CAL
START	Front-panel access key: SWEEP SETUP
START FREQUENCY	Front-panel access key: SYSTEM
STATS on OFF	Front-panel access key: MARKER FCTN
STD DONE (DEFINED)	Front-panel access key: CAL
STD OFFSET DONE	Front-panel access key: CAL
STD TYPE:LOAD	Front-panel access key: CAL
STD TYPE: OPEN	Front-panel access key: CAL
STD TYPE: SHORT	Front-panel access key: CAL
STEP SIZE	Front-panel access key: SWEEP SETUP
STIMULUS VALUE	Front-panel access key: SYSTEM
STIMULUS OFFSET	Front-panel access key: SYSTEM
STOP	Front-panel access key: SWEEP SETUP
STOP FREQUENCY	Front-panel access key: SYSTEM
STORE SEQ TO DISK	Front-panel access key: SEQ
SWEEP TIME []	Front-panel access key: SWEEP SETUP and SYSTEM
SWEEP TYPE MENU	Front-panel access key: SWEEP SETUP

Table 2-1. Location of Softkeys (16 of 18)

Softkey	Menu Location
SWR	Front-panel access key: FORMAT
SYSTEM CONTROLLER	Front-panel access key: LOCAL
SYSTEM Z0	Front-panel access key: CAL
TAKE CAL SWEEP	Front-panel access key: CAL
TALKER/LISTENER	Front-panel access key: LOCAL
TARGET	Front-panel access key: MARKER FCTN
TERMINAL IMPEDANCE	Front-panel access key: CAL
TESTPORT 1 2	Front-panel access key: MEAS
TESTSET SW CONT hld	Front-panel access key: CAL
TEXT	Front-panel access key: DISPLAY
TEXT []	Front-panel access key: COPY
THIRD	Front-panel access key: SYSTEM
THRU	Front-panel access key: CAL
THRU THRU	Front-panel access key: CAL
TIME STAMP ON off	Front-panel access key: SYSTEM
TINT	Front-panel access key: DISPLAY
TITLE	Front-panel access key: DISPLAY
TITLE SEQUENCE	Front-panel access key: SEQ
TITLE TO MEMORY	Front-panel access key: SEQ
TITLE TO P MTR/GPIB	Front-panel access key: SEQ
TITLE TO PERIPHERAL	Front-panel access key: SEQ
TITLE TO PRNTR/GPIB	Front-panel access key: SEQ
TRACKING on OFF	Front-panel access key: MARKER FCTN
Trans: E/E S11 (A/R)	Front-panel access key: MEAS
Trans: E/E S12 REV	Front-panel access key: MEAS
Trans: E/E S21 (B/R)	Front-panel access key: MEAS
Trans: E/E S21 FWD	Front-panel access key: MEAS
Trans: E/O (PORT 1→2)	Front-panel access key: MEAS
Trans: O/E (PORT 1→2)	Front-panel access key: MEAS
Trans: O/O (PORT 1→2)	Front-panel access key: MEAS
TRANSFORM MENU	Front-panel access key: SYSTEM
TRANSFORM on OFF	Front-panel access key: SYSTEM
TRANSFORM PARAMETERS	Front-panel access key: SYSTEM
TRANSFORM SPAN	Front-panel access key: SYSTEM
TRANSMISSION	Front-panel access key: CAL
TRIGGER MENU	Front-panel access key: SWEEP SETUP

Location of Softkeys**Table 2-1. Location of Softkeys (17 of 18)**

Softkey	Menu Location
TRIGGER: TRIG OFF	Front-panel access key: SWEEP SETUP
TRL/LRM OPTION	Front-panel access key: CAL
TRL*/LRM* 2-PORT	Front-panel access key: CAL
TRL 3.5 mm	Front-panel access key: CAL
TRL LINE OR MATCH	Front-panel access key: CAL
TRL REFLECT	Front-panel access key: CAL
TTL I/O	Front-panel access key: SEQ
TTL OUT	Front-panel access key: SEQ
TTL OUT HIGH	Front-panel access key: SEQ
TTL OUT LOW	Front-panel access key: SEQ
TUNED RECEIVER	Front-panel access key: SYSTEM
UNCOUPLED	Front-panel access key: MARKER FCTN
UP CONVERTER	Front-panel access key: SYSTEM
UPPER LIMIT	Front-panel access key: SYSTEM
USE MEMORY on OFF	Front-panel access key: SYSTEM
USE PASS CONTROL	Front-panel access key: LOCAL
USER	Front-panel access key: PRESET
USER KIT	Front-panel access key: CAL
USE SENSOR A / B	Front-panel access key: CAL
VELOCITY FACTOR	Front-panel access key: CAL
VIEW MEASURE	Front-panel access key: SYSTEM
VOLUME NUMBER	Front-panel access key: LOCAL
WAIT X	Front-panel access key: SEQ
WARNING	Front-panel access key: DISPLAY
WARNING []	Front-panel access key: COPY
WAVEGUIDE	Front-panel access key: CAL
WAVEGUIDE DELAY	Front-panel access key: SCALE REF
WIDE	Front-panel access key: SYSTEM
WIDTH VALUE	Front-panel access key: MARKER FCTN
WIDTHS on OFF	Front-panel access key: MARKER FCTN
WINDOW	Front-panel access key: SYSTEM
WINDOW: MAXIMUM	Front-panel access key: SYSTEM
WINDOW: MINIMUM	Front-panel access key: SYSTEM
WINDOW: NORMAL	Front-panel access key: SYSTEM
XMIT CNTRL []	Front-panel access key: LOCAL
Y: Refl	Front-panel access key: MEAS

Table 2-1. Location of Softkeys (18 of 18)

Softkey	Menu Location
Y: Trans	Front-panel access key: MEAS
Z: Refl	Front-panel access key: MEAS
Z: Trans	Front-panel access key: MEAS

Connectors, Adjustments, and Display Annotation

Table 2-2. Connectors, Adjustments, and Display Annotation (1 of 3)

Key	Description
↑ = display annotation	Fast sweep indicator. This symbol is displayed in the status notation block when sweep time is less than 1.0 second. When sweep time is greater than 1.0 second, this symbol moves along the displayed trace.
* = display annotation	Source parameters changed: measured data in doubt until a complete fresh sweep has been taken.
10 MHZ PRECISION REFERENCE connector	Option 1D5
ADJ adjustment	This adjusts the frequency of the Option 1D5 10 MHz reference.
AUX INPUT connector	This allows for a dc or ac voltage input from an external signal source, such as a detector or function generator, which you can then measure, using the S-parameter menu.
Avg = display annotation	Sweep-to-sweep averaging is on. The averaging count is shown immediately below.
BIAS CONNECT connector	These connect bias devices connected to port 1 and port 2. The fuses (1 A, 125 V) protect the port 1 and port 2 bias lines.
C? = display annotation	Stimulus parameters have changed from the error-corrected state, or interpolated error correction is on.
C2 = display annotation	Full two-port error-correction is active when either the power range for each port is different (uncoupled), or the TESTSET HOLD is activated.
Cor = display annotation	Error correction is on.
Del = display annotation	Electrical delay has been added or subtracted, or port extensions are active.
DIN KYBD connector	This connector is used for the optional AT-compatible keyboard for titles and remote front-panel operation. This provides a more convenient means to enter a title for storage files, as well as substitute for the analyzer's front panel keyboard. The keyboard must be connected to the analyzer before the power is switched on.
Disk drive	This 3.5 inch drive allows you to store and recall instrument states and measurement results for later analysis.
ext = display annotation	Waiting for an external trigger.

Table 2-2. Connectors, Adjustments, and Display Annotation (2 of 3)

Key	Description
EXT AM connector	This allows for an external analog signal input that is applied to the ALC circuitry of the analyzer's source. This input analog signal amplitude modulates the RF output signal.
EXT MON connector	Standard VGA Connector.
EXT REF connector	This allows for a frequency reference signal input that can phaselock the analyzer to an external frequency standard for increased frequency accuracy.
EXT TRIG connector	This allows connection of an external negative-going TTL-compatible signal that will trigger a measurement sweep. The trigger can be set to external through softkey functions.
Gat = display annotation	Gating is on.
H=2 = display annotation	Harmonic mode is on, and the second harmonic is being measured. (Harmonics Option 002 only.)
H=3 = display annotation	Harmonic mode is on, and the third harmonic is being measured. (Harmonics Option 002 only.)
Hld = display annotation	Hold sweep.
GPIB connector	This connector allows communication with compatible devices including external controllers, printers, plotters, disk drives, and power meters.
LIMIT TEST connector	Outputs a TTL signal of the limit test results. A TTL high state indicates a "pass" condition. A TTL low state indicates a "fail" condition.
LINE key	This switch controls ac power to the analyzer. 1 is on, 0 is off. Refer to Table 2-5, "Power-on Conditions (versus Preset)," on page 2-51 , for more information.
man = display annotation	Waiting for manual trigger.
Of? = display annotation	Frequency offset mode error, the IF frequency is not within 10 MHz of expected frequency. LO inaccuracy is the most likely cause.
Ofs = display annotation	Frequency offset mode is on.
P? = display annotation	Source power is unlevelled at start or stop of sweep.
PØ = display annotation	Source power has been automatically set to minimum, due to receiver overload.
PARALLEL PORT connector	This connector is used with parallel (or Centronics interface) peripherals such as printers and plotters. It can also be used as a general purpose I/O port, with control provided by test sequencing functions.
PC = display annotation	Power meter calibration is on.
PC? = display annotation	The analyzer's source could not be set to the desired level, following a power meter calibration.
PORT 1 and PORT 2 connectors	These ports output a signal from the source and receive input signals from a device under test. PORT 1 allows you to measure S12 and S11. PORT 2 allows you to measure S21 and S22.
PRESET key	This key returns the instrument to either a known factory preset state, or a user preset state that can be defined. Refer to "Preset Conditions" on page 2-43 for more information.

Connectors, Adjustments, and Display Annotation**Table 2-2. Connectors, Adjustments, and Display Annotation (3 of 3)**

Key	Description
PRm = display annotation	Power range is in manual mode.
PROBE POWER connector	This connector (fused inside the instrument) supplies power to an active probe for in-circuit measurements of ac circuits.
R CHANNEL connectors	These connectors allow you to apply an input signal to the analyzer's R channel, for frequency offset mode.
RS-232 connector	This connector allows the analyzer to output to a peripheral with an RS-232 (serial) input. This includes printers and plotters.
Smo = display annotation	Trace smoothing is on.
TEST SEQ connector	This connector outputs a TTL signal which can be programmed by the user in a test sequence to be high or low. By default, this output provides an end-of-sweep TTL signal. (For use with part handlers).
TEST SET I/O INTERCONNECT connector	This allows you to connect an Agilent 8702E Option 011 analyzer to an Agilent 85046A/B or 85047A S-parameter test set using the interconnect cable supplied with the test set. The S-parameter test set is then fully controlled by the analyzer.
tsH = display annotation	Indicates that the test set hold mode is engage. That is, a mode of operation is selected which would cause repeated switching of the step attenuator. This hold mode may be overridden.

Preset Conditions

When the PRESET key is pressed, the analyzer reverts to a known state called the factory preset state. This state is defined in [Table 2-4 on page 2-44](#). There are subtle differences between the preset state and the power-up state. These differences are documented in [Table 2-5 on page 2-51](#). If power to battery-protected memory is lost, the analyzer will have certain parameters set to default settings.

When line power is cycled, or the PRESET key is pressed, the analyzer performs a self-test routine. Upon successful completion of that routine, the instrument state is set to the conditions shown in [Table 2-4 on page 2-44](#). The same conditions are true following a “PRES;” “*RST;” or “RST;” command over GPIB, although the self-test routines are not executed.

You also can configure an instrument state and define it as your user preset state:

- a** Set the instrument state to your desired preset conditions.
- b** Save the state (SAVE/RECALL menu).
- c** Rename that register to “UPRESET”.
- d** Press PRESET, *PRESET: USER*.

The PRESET key is now toggled to the *USER* selection and your defined instrument state will be recalled each time you press PRESET and when you turn power on. You can toggle back to the factory preset instrument state by pressing PRESET and selecting *FACTORY*.

NOTE

When you send a preset over GPIB, you will always get the factory preset. You can, however, activate the user-defined preset over GPIB by recalling the register in which it is stored.

Preset Conditions**Table 2-3. Preset Display Formats**

Format	Scale	Reference	
		Position	Value
Log Magnitude (dB)	10.0	5.0	0.0
Phase (degree)	90.0	5.0	0.0
Group Delay (ns)	10.0	5.0	0.0
Smith Chart	1.00	–	1.0
Polar	1.00	–	1.0
Linear Magnitude	0.1	0.0	0.0
Real	0.2	5.0	0.0
Imaginary	0.2	5.0	0.0
SWR	1.00	0.0	1.0

Table 2-4. Preset Conditions (1 of 7)

Preset Conditions	Preset Value
Analyzer Mode	Component Analyzer Mode
Analyzer Mode	Component Analyzer Mode
Frequency Offset	Off
Operation Offset Value	0
Harmonic Operation	Off
Stimulus Conditions	
Sweep Type	Linear Frequency
Display Mode	Start/Stop
Trigger Type	Continuous
External Trigger	Off
Sweep Time	100 ms, Auto Mode
Start Frequency	300 kHz
Frequency Span (std.)	2999.97 MHz
Frequency Span (Opt. 006)	5999.97 MHz
Start Time	0
Time Span	100 ms
CW Frequency	1000 MHz

Table 2-4. Preset Conditions (2 of 7)

Preset Conditions	Preset Value
Source Power	0 dBm
Power Slope	0 dB/GHz; Off
Start Power	-15.0 dBm
Power Span	25 dB
Coupled Power	On
Source Power	On
Coupled Channels	On
Coupled Port Power	On
Power Range	Auto; Range 0
Number of Points	201
Frequency List	
Frequency List	Empty
Edit Mode	Start/Stop, Number of Points
Response Conditions	
Parameter	Channel 1: S11; Channel 2: S21
Conversion	Off
Format	Log Magnitude (all inputs)
Display	Data
Color Selections	Same as before PRESET
Dual Channel	Off
Active Channel	Channel 1
Frequency Blank	Disabled
Split Display	On
Intensity	If set to $\geq 50\%$, PRESET has no effect. If set to $< 50\%$, PRESET increases intensity to 50%.
Beeper: Done	On
Beeper: Warning	Off
D2/D1 to D2	Off
Title	Channel 1 = Empty Channel 2 = Empty
IF Bandwidth	3000 Hz

Preset Conditions**Table 2-4. Preset Conditions (3 of 7)**

Preset Conditions	Preset Value
Averaging Factor	16; Off
Smoothing Aperture	1% SPAN; Off
Phase Offset	0 Degrees
Electrical Delay	0 ns
Scale/Division	10 dB/Division
Calibration	
Correction	Off
Calibration Type	None
Calibration Kit	3.5 mm
System Z0	50 ohms
Velocity Factor	1
Extensions	Off
Port 1	0 s
Port 2	0 s
Input A	0 s
Input B	0 s
Chop A and B	On
Power Meter Calibration	Off
Number of Readings	1
Power Loss Correction	Off
Sensor A/B	A
Interpolated Error Correction	Off
Markers (coupled)	
Markers 1, 2, 3, 4, 5	1 GHz; All Markers Off
Last Active Marker	1
Reference Marker	None
Marker Mode	Continuous
Display Markers	On
Delta Marker Mode	Off
Coupling	On
Marker Search	Off
Marker Target Value	-3 dB
Marker Width Value	-3 dB; Off

Table 2-4. Preset Conditions (4 of 7)

Preset Conditions	Preset Value
Marker Tracking	Off
Marker Stimulus Offset	0 Hz
Marker Value Offset	0 dB
Marker Aux Offset (Phase)	0 Degrees
Marker Statistics	Off
Polar Marker	Lin Mkr
Smith Marker	R + jX Mkr
Limit Lines	Off
Limit Lines	Off
Limit Testing	Off
Limit List	Empty
Edit Mode	Upper/Lower Limits
Stimulus Offset	0 Hz
Amplitude Offset	0 dB
Limit Type	Sloping Line
Beep Fail	Off
Time Domain	Off
Transform	Off
Transform Type	Bandpass
Start Transform	-20 nanoseconds
Transform Span	40 nanoseconds
Gating	Off
Gate Shape	Normal
Gate Start	-10 nanoseconds
Gate Span	20 nanoseconds
Demodulation	Off
Window	Normal
Use Memory	Off
System Parameters	Last Active State
GPIB Addresses	Last Active State
GPIB Mode	Last Active State

Preset Conditions**Table 2-4. Preset Conditions (5 of 7)**

Preset Conditions	Preset Value
Focus	Last Active State
Clock Time Stamp	On
Preset: Factory/User	Last Selected State
Copy Configuration	
Parallel Port	Last Active State
Plotter Type	Last Active State
Plotter Port	Last Active State
Plotter Baud Rate	Last Active State
Plotter Handshake	Last Active State
GPIB Address	Last Active State
Printer Type	Last Active State
Printer Port	Last Active State
Printer Baud Rate	Last Active State
Printer Handshake	Last Active State
Printer GPIB Address	Last Active State
Disk Save Configuration (Define Store)	
Data Array	Off
Raw Data Array	Off
Formatted Data Array	Off
Graphics	Off
Data Only	Off
Directory Size	Default ^a
Save Binary	Binary
Select Disk	Internal Memory
Disk Format	LIF
Sequencing ^b	
Loop Counter	0
TTL OUT	High
Service Modes	
GPIB Diagnostic	Off

Table 2-4. Preset Conditions (6 of 7)

Preset Conditions	Preset Value
Source Phase Lock	Loop On
Sampler Correction	On
Spur Avoidance	On
Aux Input Resolution	Low
Analog Bus Mode	11 (Aux Input)
Plot	
Plot Data	On
Plot Memory	On
Plot Graticule	On
Plot Text	On
Plot Marker	On
Autofeed	On
Plot Quadrant	Full Page
Scale Plot	Full
Plot Speed	Fast
Pen Number:	
Ch1 Data	2
Ch2 Data	3
Ch1 Memory	5
Ch2 Memory	6
Ch1 Graticule	1
Ch2 Graticule	1
Ch1 Text	7
Ch2 Text	7
Ch1 Marker	7
Ch2 Marker	7
Line Type:	
Ch1 Data	7
Ch2 Data	7
Ch1 Memory	7
Ch2 Memory	7
Print	
Printer Mode	Last Active State
Auto-Feed	On

Preset Conditions**Table 2-4. Preset Conditions (7 of 7)**

Preset Conditions	Preset Value
Printer Colors	
Ch1 Data	Magenta
Ch1 Mem	Green
Ch2 Data	Blue
Ch2 Mem	Red
Graticule	Cyan
Warning	Black
Text	Black

- a. The directory size is calculated as 0.013% of the floppy disk size (which is approximately 256) or 0.005% of the hard disk size.
- b. Pressing PRESET turns off sequencing modify (edit) mode and stops any running sequence.

Power-on Conditions

Table 2-5. Power-on Conditions (versus Preset)

GPIB MODE	Talker/listener.
SAVE REGISTERS	Power meter calibration data and calibration data not associated with an instrument state are cleared.
COLOR DISPLAY	Default color values.
INTENSITY	Factory stored values. The factory values can be changed by running the appropriate service routine. Refer to the <i>Agilent 8753D Service Guide</i> .
SEQUENCES	Sequence 1 through 5 are erased.
DISK DIRECTORY	Cleared.

Reference

Power-on Conditions

Error Messages in Alphabetical Order 3-3
Error Messages in Numerical Order 3-24

Error Messages

Error Messages

This chapter contains the information to help you interpret any error messages that may be displayed on the Agilent 8702E or transmitted by the instrument over GPIB.

Some messages described in this chapter are for information only and do not indicate an error condition. These messages are not numbered and so they will not appear in the numerical listing.

Error Messages in Alphabetical Order

ABORTING COPY OUTPUT

Information Message

This message is displayed briefly if you have pressed LOCAL to abort a copy operation. If the message is not subsequently replaced by error message number 25, *PRINT ABORTED*, the copy device may be hung. Press LOCAL once more to exit the abort process and verify the status of the copy device. At this point, the copy device will probably have an error condition which must be fixed. (For example: out of paper or paper jam.)

ADDITIONAL STANDARDS NEEDED TO COVER SPAN

Error Number 68

Error correction for the selected calibration class cannot be computed until you have measured all the necessary standards to cover the current frequency span.

ADDRESSED TO TALK WITH NOTHING TO SAY

Error Number 31

You have sent a read command to the analyzer (such as ENTER 716) without first requesting data with an appropriate output command (such as OUTPUT DATA). The analyzer has no data in the output queue to satisfy the request.

ALL REGISTERS HAVE BEEN USED

Error Number 200

You have used all of the available registers; you can store no more instrument states even though you may still have sufficient memory. There are 31 registers available, plus the present instrument state.

ASCII: MISSING 'BEGIN' STATEMENT

Error Number 193

The citifile you just downloaded over GPIB or via disk was not properly organized. The analyzer is unable to read the "BEGIN" statement.

ASCII: MISSING 'CITIFILE' STATEMENT

Error Number 194

Error Messages in Alphabetical Order

The citifile you just downloaded over the GPIB or via disk was not properly organized. The analyzer is unable to read the “CITIFILE” statement.

ASCII: MISSING 'DATA' STATEMENT

Error Number 195

The citifile you just downloaded over the GPIB or via disk was not properly organized. The analyzer is unable to read the “DATA” statement.

ASCII: MISSING 'VAR' STATEMENT

Error Number 196

The citifile you just downloaded over the GPIB or via disk was not properly organized. The analyzer is unable to read the “VAR” statement.

AVERAGING INVALID ON NON-RATIO MEASURE

Error Number 13

You cannot use sweep-to-sweep averaging in single-input measurements. Sweep-sweep averaging is valid only for ratioed measurements (A/R, B/R, A/B, and S-parameters). You can use noise reduction techniques, such as narrower IF bandwidth, for single input measurements.

BAD FREQ FOR HARMONIC OR FREQ OFFSET

Error Number 181

You turned on time domain or recalled a calibration that resulted in start and stop frequencies that are beyond the allowable limits.

BATTERY FAILED. STATE MEMORY CLEARED

Error Number 183

The battery protection of the battery-operated memory has failed. The memory has been cleared. Refer to the *Agilent 8753D Service Guide* for battery replacement instructions.

BATTERY LOW! STORE SAVE REGS TO DISK

Error Number 184

The battery protection of the memory is in danger of failing. If this occurs, all of the instrument state registers stored in memory will be lost. Save these states to a disk and refer to the *Agilent 8702E User's Guide* for battery replacement instructions.

BLOCK INPUT ERROR

Error Number 34

The analyzer did not receive a complete data transmission. This is usually caused by an interruption of the bus transaction. Clear by pressing the LOCAL key or aborting the I/O process at the controller.

BLOCK INPUT LENGTH ERROR

Error Number 35

The length of the header received by the analyzer did not agree with the size of the internal array block. Refer to the *Agilent 8702E Programmer's Guide* for instructions on using analyzer input commands.

CALIBRATION ABORTED

Error Number 74

You have changed the active channel during a calibration so the calibration in progress was terminated. Make sure the appropriate channel is active and restart the calibration.

CALIBRATION REQUIRED

Error Number 63

A calibration set could not be found that matched the current stimulus state or measurement parameter. You will have to perform a new calibration.

CANNOT FORMAT DOS DISKS ON THIS DRIVE

Error Number 185

You have attempted to initialize a floppy disk to DOS format on an external disk drive that does not support writing to all 80 tracks of the double density (gray) and high density disks (usually black). The older single-sided disks (blue) had only 66 tracks and some disk drives were limited to accessing that number of tracks. To format the disk, either choose another external disk drive or use the analyzer's internal disk drive.

CANNOT MODIFY FACTORY PRESET

Error Number 199

You have attempted to rename, delete, or otherwise alter the factory preset state. The factory preset state is permanently stored in memory and cannot be altered. If your intent was to create a user preset state, you must create a new instrument state, save it, and then rename it to "UPRESET".

CANNOT READ/WRITE HFS FILE SYSTEM

Error Number 203

The disk is being accessed by the analyzer and is found to contain an HFS (hierarchical file system). The analyzer does not support HFS.

CAN'T CHANGE-ANOTHER CONTROLLER ON BUS

Error Number 37

You must remove the active controller from the bus or the controller must relinquish the bus before the analyzer can assume the system controller mode.

Error Messages in Alphabetical Order

CAN'T STORE/LOAD SEQUENCE, INSUFFICIENT MEMORY

Error Number 127

Your sequence transfer to or from a disk could not be completed due to insufficient memory.

CH1 (CH2) TARGET VALUE NOT FOUND

Error Number 159

Your target value for the marker search function does not exist on the current data trace.

CONTINUOUS SWITCHING NOT ALLOWED

Error Number 10

Your current measurement requires the power range to switch between channel 1 and channel 2. To protect the attenuator from undue mechanical wear, it will not be switched continuously. The "tsH" (test set hold) indicator in the left margin of the display indicates that the inactive channel has been put in the sweep hold mode.

COPY: device not responding; copy aborted

Error Number 170

The printer or plotter is not accepting data. Verify the cable connections, GPIB addresses, and otherwise ensure that the copy device is ready.

COPY OUTPUT COMPLETED

Information Message

The analyzer has completed outputting data to the printer or plotter. The analyzer can now accept another copy command.

CORRECTION AND DOMAIN RESET

Error Number 65

When you change the frequency range, sweep type, or number of points, error-correction is switched off and the time domain transform is recalculated, without error-correction. You can either correct the frequency range, sweep type, or number of points to match the calibration or perform a new calibration. Then perform a new time domain transform.

CORRECTION CONSTANTS NOT STORED

Error Number 3

A store operation to the EEPROM was not successful. You must change the position of the jumper on the A9 CPU assembly.

CORRECTION TURNED OFF

Error Number 66

Critical parameters in your current instrument state do not match the parameters for the calibration set, therefore correction has been turned off. The critical instrument state parameters are sweep type, start frequency, frequency span, and number of points.

CURRENT PARAMETER NOT IN CAL SET

Error Number 64

Correction is not valid for your selected measurement parameter. Either change the measurement parameters or perform a new calibration.

D2/D1 INVALID WITH SINGLE CHANNEL

Error Number 130

You can only make a D2/D1 measurement if both channels are on.

D2/D1 INVALID. CH1 CH2 NUM PTS DIFFERENT

Error Number 152

You can only make a D2/D1 measurement if both channels have the same number of points.

DEADLOCK

Error Number 111

A fatal firmware error occurred before instrument preset completed. Call your local Agilent Technologies service office.

DEMODULATION NOT VALID

Error Number 17

Demodulation is only valid for the CW time mode.

DEVICE: not on, not connect, wrong addr

Error Number 119

The device at the selected address cannot be accessed by the analyzer. Verify that the device is switched on, and check the GPIB connection between the analyzer and the device. Ensure that the device address recognized by the analyzer matches the GPIB address set on the device itself.

DIRECTORY FULL

Error Number 188

There is no room left in the directory to add files. Either delete files or get a new disk.

DISK HARDWARE PROBLEM

Error Number 39

The disk drive is not responding correctly. Refer to the disk drive operating manual.

Error Messages in Alphabetical Order

DISK IS WRITE PROTECTED

Error Number 48

The store operation cannot write to a write-protected disk. Slide the write-protect tab over the write-protect opening in order to write data on the disk.

DISK MEDIUM NOT INITIALIZED

Error Number 40

You must initialize the disk before it can be used.

DISK MESSAGE LENGTH ERROR

Error Number 190

The analyzer and the external disk drive are not communicating properly. Check the GPIB connection and then try substituting another disk drive to isolate the problem instrument.

DISK: not on, not connected, wrong addr

Error Number 38

The disk cannot be accessed by the analyzer. Verify power to the disk drive, and check the GPIB connection between the analyzer and the disk drive. Ensure that the disk drive address recognized by the analyzer matches the GPIB address set on the disk drive itself.

DISK READ/WRITE ERROR

Error Number 189

There may be a problem with your disk. Try a new floppy disk. If a new floppy disk does not eliminate the error, check hardware problems.

DISK WEAR - REPLACE DISK SOON

Error Number 49

Cumulative use of the disk is approaching the maximum. Copy files as necessary using an external controller. If no controller is available, load instrument states from the old disk and store them to a newly initialized disk using the save/recall features of the analyzer. Discard the old disk.

DOMAIN RESET

Error Number 67

Time domain calculations were reset due to a change in the frequency range, sweep type, or number of points. Perform a new time domain transform on the new state.

DOS NAME LIMITED TO 8 CHARS + 3 CHAR EXTENSION

Error Number 180

A DOS file name must meet the following criteria:

- minimum of 1 character
- first character must be an alphabetic; the remaining characters must be alphanumeric or underscores
- format is *filename.ext*
 - maximum of 8 characters in the filename
 - maximum of 3 characters in the extension field
 - a dot separates the filename from the extension field (the dot is not part of the name on the disk)

DUPLICATING TO THIS SEQUENCE NOT ALLOWED

Error Number 125

A sequence cannot be duplicated to itself.

EXCEEDED 7 STANDARDS PER CLASS

Error Number 72

When modifying calibration kits, you can define a maximum of seven standards for any class.

EXTERNAL SOURCE MODE REQUIRES CW TIME

Error Number 148

An external source can only be phase locked and measured in the CW time sweep mode.

EXT SOURCE NOT READY FOR TRIGGER

Error Number 191

There is a hardware problem with the external source. Verify the connections between the analyzer and the external source. If the connections are correct, refer to the source operating manual.

EXT SRC: NOT ON/CONNECTED OR WRONG ADDR

Error Number 162

The analyzer is unable to communicate with the external source. Check the connections and the GPIB address on the source.

FILE NOT COMPATIBLE WITH INSTRUMENT

Information Message

You cannot recall user graphics that had been saved on an earlier model of analyzer with a monochrome display. These files cannot be used with the Agilent 8702E.

FILE NOT FOUND

Error Number 192

Error Messages in Alphabetical Order

The requested file was not found on the current disk medium.

FILE NOT FOUND OR WRONG TYPE

Error Number 197

During a resave operation, either the file was not found or the type of file was not an instrument state file.

FIRST CHARACTER MUST BE A LETTER

Error Number 42

The first character of a disk file title or an internal save register title must be an alphabetic character.

FORMAT NOT VALID FOR MEASUREMENT

Error Number 75

Conversion measurements (Z or Y reflection and transmission) are not valid with Smith chart and SWR formats.

FORMATTING DATA

Information Message

The list information is being processed for a list data output to a copy device and stored in the copy spool buffer. During this time, the analyzer's resources are dedicated to this task (which takes less than a few seconds.)

FREQ OFFSET ONLY VALID IN COMPONENT ANALYZER MODE

Error Number 140

You can only make frequency offset measurements in the component analyzer mode.

FUNCTION NOT VALID

Error Number 14

The function you requested is incompatible with the current instrument state.

FUNCTION NOT VALID DURING MOD SEQUENCE

Error Number 131

You cannot perform sequencing operations while a sequence is being modified.

FUNCTION NOT VALID FOR INTERNAL MEMORY

Error Number 201

The function you selected only works with disk files.

FUNCTION ONLY VALID DURING MOD SEQUENCE

Error Number 164

You can only use the GOSUB SEQUENCE capability when you are building a sequence. Attempting to use this softkey at any other time returns an error message and no action is taken.

GPIB COPY IN PROGRESS, ABORT WITH LOCAL

Error Number 169

A GPIB copy was already in progress when you requested the GPIB for another function. To abort the first copy, press LOCAL, otherwise the GPIB is unavailable until the first copy is completed.

ILLEGAL UNIT OR VOLUME NUMBER

Error Number 46

The disk unit or volume number set in the analyzer is not valid. Refer to the disk drive operating manual.

INIT DISK removes all data from disk

Information Message

Continuing with the initialize operation will *destroy* any data currently on the disk.

INITIALIZATION FAILED

Error Number 47

The disk initialization failed, probably because the disk is damaged.

INSTRUMENT STATE MEMORY CLEARED

Error Number 56

All instrument state registers have been cleared from memory along with any saved calibration data, memory traces, and calibration kit definitions. Additionally, all user-settable selections, (such as GPIB addresses) are set to their defaults.

INSUFFICIENT MEMORY

Error Number 51

Your last front panel or GPIB request could not be implemented due to insufficient memory space. In some cases, this is a fatal error from which you can escape only by presetting the instrument.

INSUFFICIENT MEMORY FOR PRINT/PLOT

Error Number 168

There is not enough memory available for the print or plot function. Increase the available memory by changing or eliminating a memory-intensive operation such as reducing the number of points in the sweep.

Error Messages in Alphabetical Order

INSUFFICIENT MEMORY, PWR MTR CAL OFF

Error Number 154

There is not enough memory space for the power meter calibration array. Increase the available memory by clearing one or more save/recall registers, or reduce memory requirements by reducing the number of points.

INVALID CAL DATA FILE

Error Number 142

The calibration file you are attempting to read does not contain valid data.

INVALID KEY

Error Number 2

You pressed an undefined softkey.

LIST MODE OFF: INVALID WITH LO FREQ

Error Number 182

List mode has been turned off in the frequency offset mode because it is incompatible with your selected LO frequency.

LIST TABLE EMPTY

Error Number 9

The frequency list is empty. To implement list frequency mode, add segments to the list table.

LOAD RECEIVER CAL DATA FROM DISK FILE

Error Number 134

You are attempting to measure a receiver cal standard that has not been defined. Define by loading cal data from the appropriate file.

LOAD SOURCE CAL DATA FROM DISK FILE

Error Number 135

You are attempting to measure a source cal standard that has not been defined. Define by loading cal data from the appropriate file.

LOG SWEEP REQUIRES 2 OCTAVE MINIMUM SPAN

Error Number 150

A logarithmic sweep is only valid if the stop frequency is greater than four times the start frequency. For frequency spans of less than two octaves, the sweep type automatically reverts to linear sweep.

LOW PASS: FREQ LIMITS CHANGED

Information Message

The frequency domain data points must be harmonically related from dc to the stop frequency. That is, $\text{stop} = n \times \text{start}$, where n = number of points. If this condition is not true when a low pass mode (step or impulse) is selected and transform is turned on, the analyzer resets the start and stop frequencies. The stop frequency is set close to the entered stop frequency, and the start frequency is set equal to stop/n .

MEMORY FOR CURRENT SEQUENCE IS FULL

Error Number 132

All the memory in the sequence you are modifying is filled with instrument commands.

MORE SLIDES NEEDED

Error Number 71

When you use a sliding load (in a user-defined calibration kit), you must set at least three slide positions to complete the calibration.

NO CALIBRATION CURRENTLY IN PROGRESS

Error Number 69

The *RESUME CAL SEQUENCE* softkey is not valid unless a calibration is already in progress. Start a new calibration.

NO DISK MEDIUM IN DRIVE

Error Number 41

You have no disk in the current disk unit. Insert a disk or check the disk unit number stored in the analyzer.

NO FAIL FOUND

Service Error Number 114

The self-diagnose function of the instrument operates on an internal test failure. At this time, no failure has been detected.

NO FILE(S) FOUND ON DISK

Error Number 45

No files of the type created by an analyzer store operation were found on the disk. If you requested a specific file title, that file was not found on the disk.

NO IF FOUND: CHECK R INPUT LEVEL

Error Number 5

The first IF signal was not detected during pre-tune. Check the front panel R channel jumper. If there is no visible problem with the jumper, refer to the *Agilent 8753D Service Guide* for troubleshooting.

Error Messages in Alphabetical Order

NO LIMIT LINES DISPLAYED

Error Number 144

You can turn limit lines on but they cannot be displayed on polar or Smith chart display formats.

NO MARKER DELTA -SPAN NOT SET

Error Number 15

You must turn the delta marker mode on, with at least two markers displayed, in order to use the *MARKER* → *SPAN* softkey function.

NO MEMORY AVAILABLE FOR INTERPOLATION

Error Number 123

You cannot perform interpolated error correction due to insufficient memory.

NO MEMORY AVAILABLE FOR SEQUENCING

Error Number 126

You cannot modify the sequence due to insufficient memory.

NO PHASE LOCK: CHECK R INPUT LEVEL

Error Number 7

The first IF signal was detected at pre-tune, but phase lock could not be acquired. Refer to the *Agilent 8753D Service Guide* for troubleshooting.

NO SPACE FOR NEW CAL. CLEAR REGISTERS

Error Number 70

You cannot store a calibration set due to insufficient memory. You can free more memory by clearing a saved instrument state from an internal register (which may also delete an associated calibration set if all the instrument states using the calibration kit have been deleted.) You can store the saved instrument state and calibration set to a disk before clearing them. After deleting the instrument states, press PRESET to run the memory packer.

NOT ALLOWED DURING POWER METER CAL

Error Number 198

When the analyzer is performing a power meter calibration, the GPIB bus is unavailable for other functions such as printing or plotting.

NOT ENOUGH SPACE ON DISK FOR STORE

Error Number 44

The store operation will overflow the available disk space. Insert a new disk or purge files to create free disk space.

INSUFFICIENT

Error Number 143

You are attempting a response and match calibration on a parameter other than E/O or O/E.

NO VALID MEMORY TRACE

Error Number 54

If you are going to display or otherwise use a memory trace, you must first store a data trace to memory.

NO VALID STATE IN REGISTER

Error Number 55

You have requested the analyzer, over GPIB (or by sequencing), to load an instrument state from an *empty* internal register.

ONLY LETTERS AND NUMBERS ARE ALLOWED

Error Number 43

You can only use alpha-numeric characters (and underscores) in disk file titles or internal save register titles. Other symbols are not allowed, except for the “underscore” symbol.

OPTIONAL FUNCTION; NOT INSTALLED

Error Number 1

The function you requested requires a capability provided by an option to the standard analyzer. That option is not currently installed. (Option 002 harmonic measurement capability, Option 006 6 GHz operation, Option 110 deletes time domain transform, and Option 075 75 ohm impedance.)

OVERLOAD ON INPUT A, POWER REDUCED

Error Number 58

See error number 57.

OVERLOAD ON INPUT B, POWER REDUCED

Error Number 59

See error number 57.

OVERLOAD ON INPUT R, POWER REDUCED

Error Number 57

You have exceeded approximately +20 dBm at one of the test ports. The RF output power is automatically reduced to –85 dBm. The annotation P↓ appears in the left margin of the display to indicate that the power trip function has been activated. When this occurs, reset the power to a lower level, then toggle the *SOURCE PWR on OFF* softkey to switch on the power again.

Error Messages in Alphabetical Order

PARALLEL PORT NOT AVAILABLE FOR GPIO

Error Number 165

You have defined the parallel port as COPY for sequencing in the GPIB menu. To access the parallel port for general purpose I/O (GPIO), set the selection to *GPIO*.

PARALLEL PORT NOT AVAILABLE FOR COPY

Error Number 167

You have defined the parallel port as general purpose I/O (GPIO) for sequencing. The definition was made under the LOCAL key menus. To access the parallel port for copy, set the selection to *PARALLEL [COPY]*.

PHASE LOCK CAL FAILED

Error Number 4

An internal phase lock calibration routine is automatically executed at power-on, preset, and any time a loss of phase lock is detected. This message indicates that phase lock calibration was initiated and the first IF detected, but a problem prevented the calibration from completing successfully. Refer to the *Agilent 8753D Service Guide* and execute pre-tune correction test 48.

This message may appear if you connect a mixer between the RF output and R input before turning on frequency offset mode. Ignore it: it will go away when you turn on frequency offset. This message may also appear if you turn on frequency offset mode before you define the offset.

PHASE LOCK LOST

Error Number 8

Phase lock was acquired but then lost. Refer to the *Agilent 8753D Service Guide* for troubleshooting information.

PLOT ABORTED

Error Number 27

When you press the LOCAL key, the analyzer aborts the plot in progress.

PLOTTER: not on, not connect, wrong addr

Error Number 26

The plotter does not respond to control. Verify power to the plotter, and check the GPIB connection between the analyzer and the plotter. Ensure that the plotter address recognized by the analyzer matches the GPIB address set on the plotter itself.

PLOTTER NOT READY-PINCH WHEELS UP

Error Number 28

The plotter pinch wheels clamp the paper in place. If you raise the pinch wheels, the plotter indicates a “not ready” status on the bus.

POSSIBLE FALSE LOCK

Error Number 6

Phase lock has been achieved, but the source may be phase locked to the wrong harmonic of the synthesizer. Perform the source pre-tune correction routine documented in the “Adjustments and Correction Constants” chapter in the *Agilent 8753D Service Guide*.

POWER UNLEVELED

Error Number 179

There is either a hardware failure in the source or you have attempted to set the power level too high. Check to see if the power level you set is within specifications. If it is, refer to the *Agilent 8753D Service Guide* for troubleshooting. You will only receive this message over the GPIB. On the analyzer, P? is displayed.

POW MET INVALID

Error Number 116

The power meter indicates an out-of-range condition. Check the test setup.

POW MET NOT SETTLED

Error Number 118

Sequential power meter readings are not consistent. Verify that the equipment is set up correctly. If so, preset the instrument and restart the operation.

POW MET: not on/connected or wrong addr

Error Number 117

The power meter cannot be accessed by the analyzer. Verify that the power meter address and model number set in the analyzer match the address and model number of the actual power meter.

POWER SUPPLY HOT!

Error Number 21

The temperature sensors on the A8 post-regulator assembly have detected an over-temperature condition. The power supplies regulated on the post-regulator have been shut down.

POWER SUPPLY SHUT DOWN!

Error Number 22

One or more supplies on the A8 post-regulator assembly have been shut down due to an over-current, over-voltage, or under-voltage condition.

Error Messages in Alphabetical Order

PRESS [SWEEP SETUP], SELECT CW (IF) FREQ, THEN SWEPT LO

Error Number 161

When you are sweeping the RF and LO, the IF must be fixed.

PRINT ABORTED

Error Number 25

When you press the LOCAL key, the analyzer aborts output to the printer.

print color not supported with EPSON

Error Number 178

You have defined the printer type as EPSON-P2. Color print is not supported with this printer. The print will abort.

PRINTER: busy

Error Number 176

The parallel port printer is not accepting data.

PRINTER: error

Error Number 175

The parallel port printer is malfunctioning. The analyzer cannot complete the copy function.

PRINTER: not connected

Error Number 173

There is no printer connected to the parallel port.

PRINTER: not handshaking

Error Number 177

The printer at the parallel port is not responding.

PRINTER: not on line

Error Number 172

The printer at the parallel port is not set on line.

PRINTER: not on/connected or wrong addr

Error Number 24

The printer does not respond to control. Verify power to the printer, and check the GPIB connection between the analyzer and the printer. Ensure that the printer address recognized by the analyzer matches the GPIB address set on the printer itself.

PRINTER: paper error

Error Number 171

There is a paper-related problem with the parallel port printer such as a paper jam or out-of-paper condition.

PRINTER: power off

Error Number 174

The power to the printer at the parallel port is off.

PRINT/PLOT IN PROGRESS, ABORT WITH LOCAL

Error Number 166

If a print or plot is in progress and you attempt a second print or plot, this message is displayed and the second attempt is ignored. To abort a print or plot in progress, press LOCAL.

PROBE POWER SHUT DOWN!

Error Number 23

The analyzer biasing supplies to the Agilent 85024A external probe are shut down due to excessive current. Troubleshoot the probe, and refer to the power supply troubleshooting section of the *Agilent 8753D Service Guide*.

PROCESSING DISPLAY LIST

Information Message

The display information is being processed for a screen print to a copy device and stored in the copy spool buffer. During this time, the analyzer's resources are dedicated to this task (which takes less than a few seconds.)

REQUESTED DATA NOT CURRENTLY AVAILABLE

Error Number 30

The analyzer does not currently contain the data you have requested. For example, this condition occurs when you request error term arrays and no calibration is active.

SAVE FAILED. INSUFFICIENT MEMORY

Error Number 151

You cannot store an instrument state in an internal register due to insufficient memory. Increase the available memory by clearing one or more save/recall registers and pressing PRESET. The instrument state may also be saved to disk.

SELECTED SEQUENCE IS EMPTY

Error Number 124

The sequence you attempted to run does not contain instrument commands.

SELF TEST #n FAILED

Service Error Number 112

Error Messages in Alphabetical Order

Internal test #n has failed. Several internal test routines are executed at instrument preset. The analyzer reports the first failure detected. Refer to the *Agilent 8753D Service Guide* for troubleshooting information on internal tests and the self-diagnose feature.

SEQUENCE ABORTED

Error Number 157

The sequence running was stopped prematurely when you pressed the LOCAL key.

SEQUENCE MAY HAVE CHANGED, CAN'T CONTINUE

Error Number 153

When you pause a sequence, you cannot continue it if you have modified it. You must start the sequence again.

SLIDES ABORTED (MEMORY REALLOCATION)

Error Number 73

You cannot perform sliding load measurements due to insufficient memory. Reduce memory usage by clearing save/recall registers, then repeat the sliding load measurements.

SOURCE PARAMETERS CHANGED

Error Number 61

Some of the stimulus parameters of the instrument state have been changed, because you have turned correction on. A calibration set for the current measurement parameter was found and activated. The instrument state was updated to match the stimulus parameters of the calibration state.

This message also appears when you have turned on harmonic mode or frequency offset and the present frequency range cannot be used with one of these modes.

SOURCE POWER TRIPPED, RESET UNDER POWER SWEEP SETUP

Information Message

You have exceeded the maximum power level at one of the inputs and power has been automatically reduced. The annotation P↓ indicates that power trip has been activated. When this occurs, reset the power and then press SWEEP SETUP, *POWER, SOURCE PWR on OFF*, to switch on the power. This message follows error numbers 57, 58, and 59.

STARTING COPY SPOOLER

Information Message

The analyzer is beginning to output data from the spool buffer to the copy device. The analyzer resumes normal operation; the data is being output to the copy device in the background.

STOP/CW FREQ + OFFSET MUST BE < 3 GHz

Error Number 141

The output frequency of the mixer cannot violate the minimum/maximum frequency of the analyzer.

SWEEP MODE CHANGED TO CW TIME SWEEP

Error Number 187

If you select external source auto or manual instrument mode and you do not also select CW mode, the analyzer is automatically switched to CW.

SWEEP TIME INCREASED

Error Number 11

You have made instrument changes that cause the analyzer sweep time to be automatically increased. Some parameter changes that cause an increase in sweep time are narrower IF bandwidth, an increase in the number of points, and a change in sweep type.

SWEEP TIME TOO FAST

Error Number 12

The fractional-N and digital IF circuits have lost synchronization. Refer to the *Agilent 8753D Service Guide* for troubleshooting information.

SWEEP TRIGGER SET TO HOLD

Information Message

The instrument is in a hold state and is no longer sweeping.

SWEEP TYPE CHANGED TO LINEAR SWEEP

Error Number 145

If you have the frequency list mode active when you change the instrument mode to harmonic measurements and the list frequencies do not fall in the allowable frequency range of these modes the list mode is automatically turned off.

SYNTAX ERROR

Error Number 33

You have improperly formatted a GPIB command. Refer to the *Agilent 8702E Programmer's Guide* for proper command syntax.

SYST CTRL OR PASS CTRL IN LOCAL MENU

Error Number 36

Error Messages in Alphabetical Order

The analyzer is in talker/listener mode. In this mode, the analyzer cannot control a peripheral device on the bus. Use the local menu to change to system controller or pass control mode.

TEST ABORTED

Error Number 113

You have prematurely stopped a service test.

THIS LIST FREQ INVALID IN HARM/3 GHZ RNG

Error Number 133

You have set frequencies in the list that are outside of the allowable frequency range for harmonic measurements, or are greater than 3 GHz on instruments without Option 006. Reduce the frequency range of the list.

TOO MANY NESTED SEQUENCES. SEQ ABORTED

Error Number 164

You can only nest sequences to a maximum level of six. The sequence will abort if you nest more than six.

TOO MANY SEGMENTS OR POINTS

Error Number 50

You can have a maximum of 30 segments or 1632 points in frequency list mode. In power meter calibrations, you can have a maximum of 12 segments for power sensor cal factors and power loss functions.

TRANSFORM, GATE NOT ALLOWED

Error Number 16

You can perform a time domain transformation only in linear and CW sweep types.

TROUBLE! CHECK SETUP AND START OVER

Service Error Number 115

Your equipment setup for the adjustment procedure in progress is not correct. Check the setup diagram and instructions in the *Agilent 8753D Service Guide*. Start the procedure again.

WAITING FOR CLEAN SWEEP

Information Message

In single sweep mode, the instrument ensures that all changes to the instrument state, if any, have been implemented before taking the sweep. The command that you have initiated is being processed and will not be complete until the new sweep is completed. An asterisk * is displayed in the left margin of the LCD until a complete fresh sweep has been taken.

WAITING FOR DISK

Information Message

This message is displayed between the start and finish of a read or write operation to a disk.

WAITING FOR GPIB CONTROL

Information Message

You have instructed the analyzer to use pass control (USEPASC). When you send the analyzer an instruction that requires active controller mode, the analyzer requests control of the bus and simultaneously displays this message. If the message remains, the system controller is not relinquishing the bus.

WRITE ATTEMPTED WITHOUT SELECTING INPUT TYPE

Error Number 32

You have sent the data header “#A” to the analyzer with no preceding input command (such as INPUDATA). The instrument recognized the header but did not know what type of data to receive. Refer to the *Agilent 8702E Programmer's Guide* for command syntax information.

WRONG DISK FORMAT, INITIALIZE DISK

Error Number 77

You have attempted to store, load, or read file titles, but your disk format does not conform to the Logical Interchange Format (LIF). You must initialize the disk before reading or writing to it.

Error Messages in Numerical Order

Table 3-1. Numerical Listing of Error Messages (1 of 7)

Error Number	Error
1	OPTIONAL FUNCTION; NOT INSTALLED
2	INVALID KEY
3	CORRECTION CONSTANTS NOT STORED
4	PHASE LOCK CAL FAILED
5	NO IF FOUND: CHECK R INPUT LEVEL
6	POSSIBLE FALSE LOCK
7	NO PHASE LOCK: CHECK R INPUT LEVEL
8	PHASE LOCK LOST
9	LIST TABLE EMPTY
10	CONTINUOUS SWITCHING NOT ALLOWED
11	SWEEP TIME INCREASED
12	SWEEP TIME TOO FAST
13	AVERAGING INVALID ON NON-RATIO MEASURE
14	FUNCTION NOT VALID
15	NO MARKER DELTA - SPAN NOT SET
16	TRANSFORM, GATE NOT ALLOWED
17	DEMODULATION NOT VALID
18	not used

Table 3-1. Numerical Listing of Error Messages (2 of 7)

Error Number	Error
19	LIST TABLE EMPTY: occurs if user selects LIST sweep type but there is no list frequency table
20	AIR FLOW RESTRICTED: CHECK FAN FILTER
21	POWER SUPPLY HOT!
22	POWER SUPPLY SHUT DOWN!
23	PROBE POWER SHUT DOWN!
24	PRINTER: not on, not connect, wrong addr
25	PRINT ABORTED
26	PLOTTER: not on, not connect, wrong addr
27	PLOT ABORTED
28	PLOTTER NOT READY-PINCH WHEELS UP
30	REQUESTED DATA NOT CURRENTLY AVAILABLE
31	ADDRESSED TO TALK WITH NOTHING TO SAY
32	WRITE ATTEMPTED WITHOUT SELECTING INPUT TYPE
33	SYNTAX ERROR
34	BLOCK INPUT ERROR
35	BLOCK INPUT LENGTH ERROR
36	SYST CTRL OR PASS CTRL IN LOCAL MENU
37	CAN'T CHANGE-ANOTHER CONTROLLER ON BUS
38	DISK: not on, not connected, wrong addr
39	DISK HARDWARE PROBLEM
40	DISK MEDIUM NOT INITIALIZED
41	NO DISK MEDIUM IN DRIVE
42	FIRST CHARACTER MUST BE A LETTER
43	ONLY LETTERS AND NUMBERS ARE ALLOWED

Error Messages in Numerical Order**Table 3-1. Numerical Listing of Error Messages (3 of 7)**

Error Number	Error
44	NOT ENOUGH SPACE ON DISK FOR STORE
45	NO FILE(S) FOUND ON DISK
46	ILLEGAL UNIT OR VOLUME NUMBER
47	INITIALIZATION FAILED
48	DISK IS WRITE PROTECTED
49	DISK WEAR-REPLACE DISK SOON
50	TOO MANY SEGMENTS OR POINTS
51	INSUFFICIENT MEMORY
52	not used
54	NO VALID MEMORY TRACE
55	NO VALID STATE IN REGISTER
56	INSTRUMENT STATE MEMORY CLEARED
57	OVERLOAD ON INPUT R, POWER REDUCED
58	OVERLOAD ON INPUT A, POWER REDUCED
59	OVERLOAD ON INPUT B, POWER REDUCED
61	SOURCE PARAMETERS CHANGED
63	CALIBRATION REQUIRED
64	CURRENT PARAMETER NOT IN CAL SET
65	CORRECTION AND DOMAIN RESET
66	CORRECTION TURNED OFF
67	DOMAIN RESET
68	ADDITIONAL STANDARDS NEEDED TO COVER SPAN
69	NO CALIBRATION CURRENTLY IN PROGRESS
70	NO SPACE FOR NEW CAL CLEAR REGISTERS

Table 3-1. Numerical Listing of Error Messages (4 of 7)

Error Number	Error
71	MORE SLIDES NEEDED
72	EXCEEDED 7 STANDARDS PER CLASS
73	SLIDES ABORTED (MEMORY REALLOCATION)
74	CALIBRATION ABORTED
75	FORMAT NOT VALID FOR MEASUREMENT
77	WRONG DISK FORMAT, INITIALIZE DISK
111	DEADLOCK
112	SELF TEST #n FAILED
113	TEST ABORTED
114	NO FAIL FOUND
115	TROUBLE! CHECK SETUP AND START OVER
116	POW MET INVALID
117	POW MET: not on/connected or wrong addr
118	POW MET NOT SETTLED
119	DEVICE: not on/connect or wrong addr
123	NO MEMORY AVAILABLE FOR INTERPOLATION
124	SELECTED SEQUENCE IS EMPTY
125	DUPLICATING TO THIS SEQUENCE NOT ALLOWED
126	NO MEMORY AVAILABLE FOR SEQUENCING
127	CAN'T STORE/LOAD SEQUENCE, INSUFFICIENT MEMORY
130	D2/D1 INVALID WITH SINGLE CHANNEL
131	FUNCTION NOT VALID DURING MOD SEQUENCE
132	MEMORY FOR CURRENT SEQUENCE IS FULL
133	THIS LIST FREQ INVALID IN HARM/3 GHZ RNG

Error Messages in Numerical Order**Table 3-1. Numerical Listing of Error Messages (5 of 7)**

Error Number	Error
134	LOAD RECEIVER CAL DATA FROM DISK FILE
135	LOAD SOURCE CAL DATA FROM DISK FILE
140	FREQ OFFSET ONLY VALID IN COMPONENT ANALYZER MODE
141	STOP/CW FREQ + OFFSET MUST BE <3 GHz
142	INVALID CAL DATA FILE
143	NOT VALID FOR CURRENT PARAMETER
144	NO LIMIT LINES DISPLAYED
145	SWEEP TYPE CHANGED TO LINEAR SWEEP
148	EXTERNAL SOURCE MODE REQUIRES CW TIME
150	LOG SWEEP REQUIRES 2 OCTAVE MINIMUM SPAN
151	SAVE FAILED INSUFFICIENT MEMORY
152	D2/D1 INVALID CH1 CH2 NUM PTS DIFFERENT
153	SEQUENCE MAY HAVE CHANGED, CAN'T CONTINUE
154	INSUFFICIENT MEMORY, PWR MTR CAL OFF
157	SEQUENCE ABORTED
159	CH1 (CH2) TARGET VALUE NOT FOUND
161	PRESS [SWEEP SETUP], SELECT CW (IF) FREQ, THEN SWEPT LO
162	EXT SRC: NOT ON/CONNECTED OR WRONG ADDR
163	FUNCTION ONLY VALID DURING MOD SEQUENCE
164	TOO MANY NESTED SEQUENCES
165	PARALLEL PORT NOT AVAILABLE FOR GPIO
166	PRINT/PLOT IN PROGRESS, ABORT WITH LOCAL
167	PARALLEL PORT NOT AVAILABLE FOR COPY
168	INSUFFICIENT MEMORY FOR PRINT/PLOT

Table 3-1. Numerical Listing of Error Messages (6 of 7)

Error Number	Error
169	GPIB COPY IN PROGRESS, ABORT WITH LOCAL
170	COPY:device not responding; copy aborted
171	PRINTER: paper error
172	PRINTER: not on line
173	PRINTER: not connected
174	PRINTER: power off
175	PRINTER: error
176	PRINTER: busy
177	PRINTER: not handshaking
178	print color not supported with EPSON
179	POWER UNLEVELED
180	DOS NAME LIMITED TO 8 CHARS + 3 CHAR EXTENSION
181	BAD FREQ FOR HARMONIC OR FREQ OFFSET
182	LIST MODE OFF: INVALID WITH LO FREQ
183	BATTERY FAILED. STATE MEMORY CLEARED
184	BATTERY LOW! STORE SAVE REGS TO DISK
185	CANNOT FORMAT DOS DISKS ON THIS DRIVE
187	SWEEP MODE CHANGED TO CW TIME SWEEP
188	DIRECTORY FULL
189	DISK READ/WRITE ERROR
190	DISK MESSAGE LENGTH ERROR
191	EXT SOURCE NOT READY FOR TRIGGER
192	FILE NOT FOUND
193	ASCII: MISSING 'BEGIN' statement

Error Messages in Numerical Order**Table 3-1. Numerical Listing of Error Messages (7 of 7)**

Error Number	Error
194	ASCII: MISSING 'CITIFILE' statement
195	ASCII: MISSING 'DATA' statement
196	ASCII: MISSING 'VAR' statement
197	FILE NOT FOUND OR WRONG TYPE
198	NOT ALLOWED DURING POWER METER CAL
199	CANNOT MODIFY FACTORY PRESET
200	ALL REGISTERS HAVE BEEN USED
201	FUNCTION NOT VALID FOR INTERNAL MEMORY

Instrument Specifications	4-3
Instrument Specifications (Option 011)	4-10
Instrument General Characteristics	4-18
Environmental Characteristics	4-22
System E/E Characteristics	4-24
Agilent 8702E (50 Ω) with 7 mm Test Ports	4-24
Agilent 8702E (50 Ω) with Type-N Test Ports	4-27
Agilent 8702E (50 Ω) with 3.5 mm Test Ports	4-31
Agilent 8702E (75 Ω) with Type-N Test Ports	4-34
Agilent 8702E (75 Ω) with Type-F Test Ports	4-38
System O/E Characteristics	4-53
3 GHz and 6 GHz 50 Ω System Configuration	4-54
3 GHz and 6 GHz 50 Ω System Configuration for Agilent 8702E Option 011 and Agilent 11889A RF Interface Kit	4-59
3 GHz and 6 GHz 75 Ω System Configuration	4-65
System E/O Characteristics	4-68
3 GHz and 6 GHz 50 Ω System Configuration	4-69
3 GHz and 6 GHz 50 Ω System Configuration for Agilent 8702E Option 011 and Agilent 11889A RF Interface Kit	4-74
3 GHz and 6 GHz 75 Ω System Configuration	4-80
System O/O Characteristics	4-83
3 GHz and 6 GHz 50 Ω System Configuration	4-83
3 GHz and 6 GHz 50 Ω System Configuration for Agilent 8702E Option 011 and Agilent 11889A RF Interface Kit	4-88
Lightwave Receiver Measurement Repeatability	4-94
GPIB Interface	4-96
Regulatory Information	4-97

Specifications and Regulatory Information

Specifications and Regulatory Information

This chapter lists specification and characteristics of the instrument. The distinction between these terms is described as follows:

- Specifications describe warranted performance over the temperature range 0°C to +55°C and relative humidity <95% (unless otherwise noted). All specifications apply after the instrument's temperature has been stabilized after one hour of continuous operation.
- *Characteristics* provide useful information by giving functional, but nonwarranted, performance parameters. *Characteristics are printed in italics.*

Calibration Cycle

This instrument requires periodic verification of performance. The instrument should have a complete verification of specifications at least once every two years.

Instrument Specifications

The specifications, listed in [Table 4-1 on page 4-3](#), range from those guaranteed by Agilent Technologies, to those typical of most Agilent 8702E instruments, but not guaranteed.

Codes in the far right column of the table reference a specification definition, listed below. These definitions are intended to clarify the extent to which Agilent Technologies supports the specified performance of the Agilent 8702E.

S-1	This performance parameter is verifiable using performance tests documented in the service manual.
S-2	Due to limitations on available industry standards, the guaranteed performance of the instrument cannot be verified outside the factory. Field procedures can verify performance with a confidence prescribed by available standards.
S-3	These specifications are generally digital functions or are mathematically derived from tested specifications, and can therefore be verified by functional pass/fail testing.
T	Typical, but non-warranted, performance characteristics intended to provide information useful in applying the instrument. Typical characteristics are representative of most instruments, though not necessarily tested in each unit. Not field tested.

Table 4-1. Agilent 8702E Instrument Specifications and Characteristics (1 of 7)

Description	Specification or <i>Characteristic</i>	Code
TEST PORT OUTPUTS		
Frequency Characteristics		
Range		
Standard	30 kHz to 3 GHz	S-1
Option 006	30 kHz to 6 GHz	S-1
Accuracy (at 25°C ±5°C)	±10 ppm	

Specifications and Regulatory Information
Instrument Specifications

Table 4-1. Agilent 8702E Instrument Specifications and Characteristics (2 of 7)

Description	Specification or <i>Characteristic</i>	Code
Stability		
0° to 55°C	±7.5 ppm	T
per year	±3 ppm	T
Resolution	1 Hz	S-3
Output Power Characteristics		
Range	–85 to +10 dBm	S-1
Resolution	0.05 dB	S-3
Level Accuracy (at 0 dBm output level) (at 25°C ±5°C) ^a	±1.0 dB	S-1 ^b
Linearity (at 25°C ±5°C) ^a		
–15 to +5 dBm	±0.2 dB (relative to 0 dBm output level)	S-1
+5 to +10 dBm	±0.5 dB (relative to 0 dBm output level)	S-1
Impedance	50 ohms	T
	>16 dB return loss to 3 GHz	T
	>14 dB return loss to 6 GHz	T
Spectral Purity Characteristics		
2nd Harmonic (16 MHz to 3 GHz)		
at +10 dBm output level	<–25 dBc	S-1 ^b
at 0 dBm output level	<–40 dBc	T
at –10 dBm output level	<–50 dBc	T
3rd Harmonic (16 MHz to 2 GHz)		
at +10 dBm output level	<–25 dBc	S-1 ^b
at 0 dBm output level	<–40 dBc	T
at –10 dBm output level	<–50 dBc	T
Non-Harmonic Spurious Signals Mixer Related		
at +10 dBm output level	<–30 dBc	T
at –10 dBm output level	<–55 dBc	T
TEST PORT INPUTS		
Characteristics		
Frequency Range		
Standard	30 kHz to 3 GHz	S-1
Option 006	30 kHz to 6 GHz	S-1
Impedance	50 ohms nominal	
30 kHz to 50 kHz	≥10 dB return loss	T
50 kHz to 300 kHz	≥18 dB return loss	T
300 kHz to 1.3 GHz	≥18 dB return loss	S-1
1.3 GHz to 3 GHz	≥16 dB return loss	S-1
3 GHz to 6 GHz	≥14 dB return loss	S-1
Maximum Input Level	+10 dBm	S-1

Table 4-1. Agilent 8702E Instrument Specifications and Characteristics (3 of 7)

Description	Specification or Characteristic	Code
<i>Damage Level</i>	+26 dBm or >35 Vdc	T
Average Noise Level		
50 kHz to 3 GHz		
3 kHz IF bandwidth	-82 dBm	S-1 ^b
10 Hz IF bandwidth	-102 dBm	S-1 ^b
	-110 dBm	T
3 GHz to 6 GHz		
3 kHz IF bandwidth	-77 dBm	S-1 ^b
10 Hz IF bandwidth	-97 dBm	S-1 ^b
	-105 dBm	T
Frequency Response (25 ±5°C)		
300 kHz to 3 GHz	±1 dB	S-1 ^b
3 GHz to 6 GHz	±2 dB	S-1 ^b
Internally Generated Harmonics (Option 002)		
2nd Harmonic		
at +8 dBm input level	<-15 dBc	S-1 ^b
at +0 dBm input level	<-30 dBc	T
at -15 dBm input level	<-45 dBc	T
3rd Harmonic		
at +8 dBm input level	<-30 dBc	S-1 ^b
at +0 dBm input level	<-50 dBc	T
at -15 dBm input level	<-50 dBc	T
Harmonic Measurement Accuracy (25 ±5°C)		
16 MHz to 3 GHz	±1 dB	S-1
3 GHz to 6 GHz ^c	±3 dB	S-1
<i>Harmonic Measurement Dynamic Range</i> (with output at -10 dBm and input at <-15 dBm)	-40 dBc	T
R CHANNEL INPUT		
Frequency Offset Operation ^{d,e}		
Frequency Range ^c	300 kHz to 6 GHz	S-1
R Channel Input Requirements	0 to -35 dBm, to 3 GHz	S-1
(required for phase-locked operation)	0 to -30 dBm, 3 GHz to 6 GHz	S-1
<i>LO Spectral Purity and Accuracy</i>		
<i>Maximum Spurious Input</i>	<-25 dBc	T
<i>Residual FM</i>	<20 kHz	T
<i>Frequency Accuracy</i>	-1 to +1 MHz of nominal frequency	T
Accuracy (see Magnitude Characteristics and Phase Characteristics)		

Instrument Specifications**Table 4-1. Agilent 8702E Instrument Specifications and Characteristics (4 of 7)**

Description	Specification or <i>Characteristic</i>	Code
External Source Mode ^{e,f} (CW Time sweep only)		
Frequency Range ^c	300 kHz to 6 GHz	S-1
<i>R Input Requirements</i>		
<i>Power Level</i>	0 to -25 dBm	T
<i>Spectral Purity</i>		
<i>Maximum Spurious Input</i>	<-30 dBc	T
<i>Residual FM</i>	<20 kHz	T
<i>Settling Time</i>		
<i>Auto</i>	500 ms	T
<i>Manual</i>	50 ms	T
<i>Frequency Readout Accuracy (auto)</i>	0.1%	T
<i>Input Frequency Margin</i>		
<i>Manual</i>	-0.5 to 5 MHz	T
<i>Auto</i>		
≤50 MHz	±5 MHz of nominal CW frequency	T
>50 MHz	±10% of nominal CW frequency	T
Accuracy (see Magnitude Characteristics and Phase Characteristics) ^f		
INPUT GENERAL		
Magnitude Characteristics		
Display Resolution	0.01 dB/division	S-3
Marker ^a Resolution	0.001 dB	S-3
Dynamic Range ^b		
30 kHz to 300 kHz	100 dB	T
300 kHz to 16 MHz	100 dB (std), 105 dB (option 075)	S-1
300 kHz to 1.3 GHz	110 dB (std), 105 dB (option 075)	S-1
1.3 GHz to 3 GHz	110 dB (std), 105 dB (option 075)	S-1
3 GHz to 6 GHz	105 dB	S-1
Dynamic Accuracy (10 Hz BW, inputs Test Port 1 and Test Port 2; R to -35 dBm) (see graph)		S-1

Table 4-1. Agilent 8702E Instrument Specifications and Characteristics (5 of 7)

Description	Specification or <i>Characteristic</i>	Code
Dynamic Accuracy (Magnitude)		
Trace Noise ⁱ		
30 kHz to 3 GHz	<0.006 dB rms	S-1
3 GHz to 6 GHz	<0.010 dB rms	S-1
Reference Level		
Range	±500 dB	S-3
Resolution	0.001 dB	S-3
<i>Stability</i>		
30 kHz to 3 GHz	0.02 dB/°C	T
3 GHz to 6 GHz	0.04 dB/°C	T
Phase Characteristics		
Range	±180°	S-3
Display Resolution	0.01°/division	S-3
Marker Resolution ^g	0.01°	S-3
Dynamic Accuracy (10 Hz BW, inputs Test Port 1 and Test Port 2; R to -35 dBm) (see graph)		S-1

Specifications and Regulatory Information
Instrument Specifications

Table 4-1. Agilent 8702E Instrument Specifications and Characteristics (6 of 7)

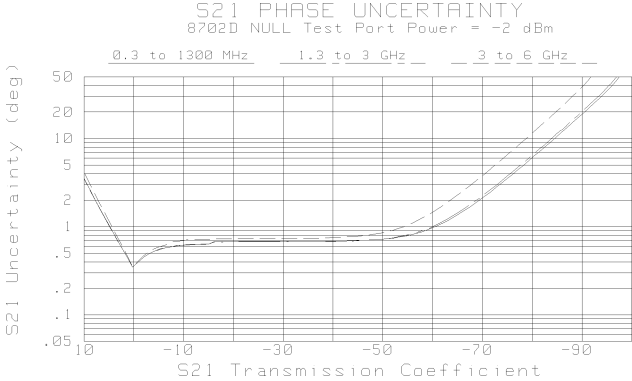
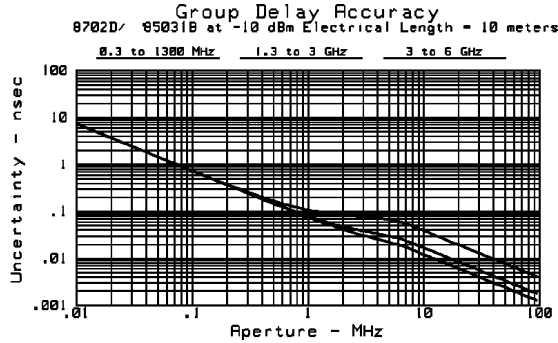
Description	Specification or <i>Characteristic</i>	Code
<div style="text-align: center;"> <p>S21 PHASE UNCERTAINTY 8702D NULL Test Port Power = -2 dBm</p> <p>0.3 to 1300 MHz 1.3 to 3 GHz 3 to 6 GHz</p>  <p>S21 Uncertainty (deg)</p> <p>S21 Transmission Coefficient</p> </div>		
Trace Noise (+5 dBm into Test Port, ratio measurement)		
30 kHz to 3 GHz	<0.038° rms	S-1
3 GHz to 6 GHz	<0.070° rms	S-1
Reference Level		
Range	±500°	S-3
Resolution	0.01°	S-3
<i>Stability</i>		
30 kHz to 3 GHz	0.05°/degree C	T
3 GHz to 6 GHz	0.20°/degree C	T
Polar Characteristics (Ratio Measurement)		
Range	10 x 10 ⁻¹² up to 1000 units full scale	S-3
Reference	range of ±500 units	S-3
Group Delay Characteristics		
Group delay is computed by measuring the phase change within a specified frequency step (determined by the frequency span and the number of points per sweep).		
Aperture (selectable)	(frequency span)/(number of points – 1)	S-3
Maximum Aperture	20% of frequency span	S-3
Range	1/2 x (1/minimum aperture)	S-3
(The maximum delay is limited to measuring no more than 180° of phase change within the minimum aperture.)		
Accuracy	(see graph)	S-3

Table 4-1. Agilent 8702E Instrument Specifications and Characteristics (7 of 7)

Description	Specification or <i>Characteristic</i>	Code
The following graph shows group delay accuracy with 7 mm full 2-port calibration and a 10 Hz IF bandwidth. Insertion loss is assumed to be <2 dB and electrical length to be ten meters.		

Group Delay Accuracy vs. Aperture



In general, the following formula can be used to determine the accuracy, in seconds, of specific group delay measurement:

$$\pm[0.003 \times \text{Phase Accuracy (deg)}] / \text{Aperture (Hz)}$$

Depending on the aperture and device length, the phase accuracy used is either incremental phase accuracy or worst case phase accuracy.

- a. Typical 30 kHz to 300 kHz and typical from 2 to 3 GHz for Option 075.
- b. Explicitly tested as part of an on-site verification performed by Agilent Technologies.
- c. Operation from 3 GHz to 6 GHz requires Option 006.
- d. The Agilent 8702E RF source characteristics in this mode are dependent on the stability of the external LO source. The RF source tracks the LO to maintain a stable IF signal at the R channel receiver input. Degradation in accuracy is negligible with an Agilent 8642A/B or Agilent 8656B RF signal generator as the LO source.
- e. Refer to the Agilent 8702E descriptions and options in this manual for a functional description.
- f. Measurement accuracy is dependent on the stability of the input signal.
- g. Marker resolution for magnitude, phase, and delay is dependent upon the value measured; resolution is limited to 5 digits.
- h. The specifications described apply to transmission measurements using 10 Hz IF BW and full 2-port correction. Dynamic range is limited by the maximum test port power and the receiver's noise floor.
- i. CW sweep, +5 dBm into Test Port, ratio measurement, 3 kHz BW.

Instrument Specifications (Option 011)

The specifications, listed in [Table 4-2 on page 4-10](#), range from those guaranteed by Agilent Technologies, to those typical of most Agilent 8702E Option 011 instruments, but not guaranteed.

Codes in the far right column of the table reference a specification definition, listed below. These definitions are intended to clarify the extent to which Agilent Technologies supports the specified performance of the Agilent 8702E Option 011.

S-1	This performance parameter is verifiable using performance tests documented in the service manual.
S-2	Due to limitations on available industry standards, the guaranteed performance of the instrument cannot be verified outside the factory. Field procedures can verify performance with a confidence prescribed by available standards.
S-3	These specifications are generally digital functions or are mathematically derived from tested specifications, and can therefore be verified by functional pass/fail testing.
T	Typical, but non-warranted, performance characteristics intended to provide information useful in applying the instrument. Typical characteristics are representative of most instruments, though not necessarily tested in each unit. Not field tested.

Table 4-2. Agilent 8702E Option 011 Specifications and Characteristics (1 of 8)

Description	Specification or <i>Characteristic</i>	Code
SOURCE		
Frequency Characteristics		
Range		
Without Option 006	300 kHz to 3 GHz	S-1 ^a
With Option 006	30 kHz to 6 GHz	S-1 ^a

Table 4-2. Agilent 8702E Option 011 Specifications and Characteristics (2 of 8)

Description	Specification or <i>Characteristic</i>	Code
Accuracy (at 25°C ±5°C)	±1.0 ppm	
Stability		
0° to 55°C	±7.5 ppm	T
per year	±3 ppm	T
Resolution	1 Hz	S-3
Output Power Characteristics		
Range		
Without Option 006	–5 to +20 dBm	S-1 ^a
With Option 006	–5 to +20 dBm	S-1 ^a
Resolution	0.05 dB	S-3
Level Accuracy (at +10 dBm output level) (at 25°C ±5°C) ^b	±1.0 dB	S-1 ^a
Linearity (at 25°C ±5°C) ^b		
–5 to +15 dBm ^c	±0.25 dB (relative to +10 dBm output level)	S-1
+15 to +20 dBm ^d	±0.5 dB (relative to +10 dBm output level)	S-1
<i>Impedance</i>	<i>50 ohms nominal</i>	
Spectral Purity Characteristics (with 0 to –10 dBm into R input)		
2nd Harmonic (16 MHz to 3 GHz)		
at +20 dBm output level	<–25 dBc	S-1 ^a
at +10 dBm output level	<–40 dBc	T
at 0 dBm output level	<–50 dBc	T
3rd Harmonic (16 MHz to 2 GHz)		
at +20 dBm output level	<–25 dBc	S-1 ^a
at +10 dBm output level	<–40 dBc	T
at 0 dBm output level	<–50 dBc	T
<i>Non-Harmonic Spurious Signals Mixer Related</i>		
at +20 dBm output level	<–30 dBc	T
at 0 dBm output level	<–55 dBc	T
Phase Noise (10 kHz offset from fundamental in 1 Hz bandwidth)		
f < 135 MHz	–90 dBc	S-1
f ≥ 135 MHz	[–90 + 20log(f/135 MHz)]dBc	S-1

Specifications and Regulatory Information
Instrument Specifications (Option 011)

Table 4-2. Agilent 8702E Option 011 Specifications and Characteristics (3 of 8)

Description	Specification or <i>Characteristic</i>	Code
RECEIVER		
Characteristics		
Frequency Range		
Without Option 006	30 kHz to 3 GHz	S-1 ^a
With Option 006	30 kHz to 6 GHz	S-1 ^a
Impedance		
<i>30 kHz to 50 kHz</i>	≥ 10 dB return loss	T
<i>50 kHz to 2 MHz</i>	≥ 18 dB return loss	T
2 MHz to 1.3 GHz	≥ 23 dB return loss	S-1
1.3 GHz to 3 GHz	≥ 20 dB return loss	S-1
<i>3 GHz to 6 GHz</i>	≥ 8 dB return loss	T
Dynamic Range (10 Hz IF bandwidth)		
A, B		
<i>30 kHz to 50 kHz</i>	90 dB	T
<i>50 kHz to 300 kHz</i>	100 dB	T
300 kHz to 3 GHz ^e	110 dB	S-1
3 GHz to 6 GHz	105 dB	S-1
R		
<i>30 kHz to 300 kHz</i>	30 dB	T
300 kHz to 3 GHz	35 dB	S-1
3 GHz to 6 GHz	30 dB	S-1
Maximum Input Level		
<i>Damage Level</i>		
+20 dBm or >25 Vdc		
Average Noise Level		
50 kHz to 3 GHz		
3 kHz IF bandwidth	-90 dBm	S-1
<i>10 Hz IF bandwidth</i>	-110 dBm	S-1
	-120 dBm	T
3 GHz to 6 GHz		
3 kHz IF bandwidth	-85 dBm	S-1
<i>10 Hz IF bandwidth</i>	-105 dBm	S-1
	-115 dBm	T
Minimum R Level (required for source operation)		
300 kHz to 3 GHz	-35 dBm	S-1
3 GHz to 6 GHz	-30 dBm	S-1
Input Crosstalk (10 Hz IF bandwidth)		

Table 4-2. Agilent 8702E Option 011 Specifications and Characteristics (4 of 8)

Description	Specification or <i>Characteristic</i>	Code
300 kHz to 1 GHz	-100 dB	S-1
1 GHz to 3 GHz	-90 dB	S-1
3 GHz to 4.5 GHz	-82 dB	S-1
4.5 GHz to 6 GHz	-75 dB	S-1
Internally Generated Harmonics (Option 002)		
2nd Harmonic		
at 0 dBm input level	<-15 dBc	S-1 ^a
at -10 dBm input level	<-35 dBc	T
at -30 dBm input level	<-45 dBc	T
3rd Harmonic		
at 0 dBm input level	<-30 dBc	S-1 ^a
at -10 dBm input level	<-50 dBc	T
at -30 dBm input level	<-50 dBc	T
Harmonic Measurement Accuracy (25 ±5°C)		
16 MHz to 3 GHz	±1 dB	S-1
3 GHz to 6 GHz	±3 dB	S-1
<i>Harmonic Measurement Dynamic Range (with output at 0 dBm and receiver at <-30 dBm)</i>	-40 dBc	T
R CHANNEL INPUT		
Frequency Offset Operation ^f ^g		
Frequency Range	300 kHz to 6 GHz	S-1
R Channel Input Requirements	0 to -35 dBm, to 3 GHz	S-1
(required for phase-locked operation)	0 to -30 dBm, 3 GHz to 6 GHz	S-1
<i>LO Spectral Purity and Accuracy</i>		
<i>Maximum Spurious Input</i>	<-25 dBc	T
<i>Residual FM</i>	<20 kHz	T
<i>Frequency Accuracy</i>	-1 to +1 MHz of nominal frequency	T
Accuracy (see Magnitude Characteristics and Phase Characteristics)		
External Source Mode ^{f,h} (CW Time sweep only)		
Frequency Range	300 kHz to 6 GHz	S-1
R Input Requirements		
Power Level	0 to -25 dBm	S-1
<i>Spectral Purity</i>		
<i>Maximum Spurious Input</i>	<-30 dBc	T
<i>Residual FM</i>	<20 kHz	T
<i>Setting Time</i>		

Specifications and Regulatory Information
Instrument Specifications (Option 011)

Table 4-2. Agilent 8702E Option 011 Specifications and Characteristics (5 of 8)

Description	Specification or <i>Characteristic</i>	Code
Auto	500 ms	T
Manual	50 ms	T
Frequency Readout Accuracy (auto)	0.1%	T
Input Frequency Margin		
Manual	-0.5 to 5 MHz	T
Auto		
≤50 MHz	±5 MHz of nominal CW frequency	T
>50 MHz	±10% of nominal CW frequency	T
Accuracy (see Magnitude Characteristics and Phase Characteristics) ^h		
RECEIVER GENERAL		
Magnitude Characteristics		
Display Resolution	0.001 dB/division	S-3
Marker Resolution	0.001 dB	S-3
Dynamic Accuracy (10 Hz BW, inputs A, B; R to -35 dBm)	(see graph)	S-1
Dynamic Accuracy (Magnitude)		

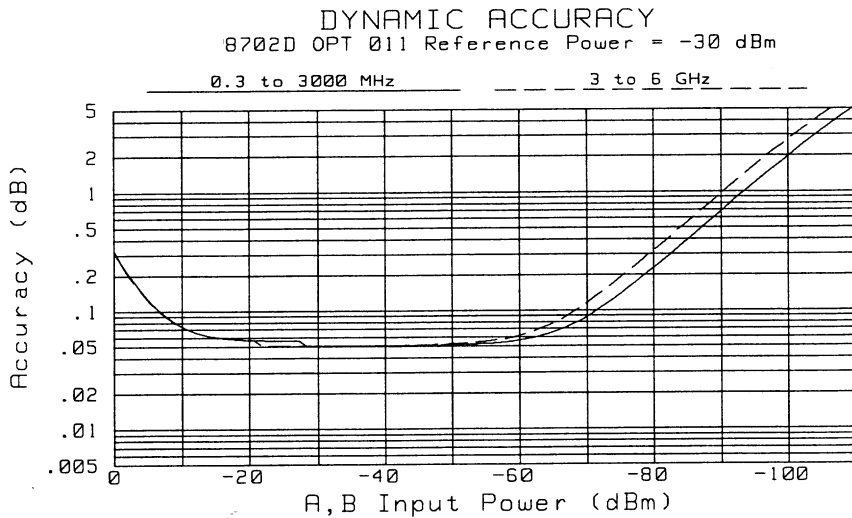


Table 4-2. Agilent 8702E Option 011 Specifications and Characteristics (6 of 8)

Description	Specification or <i>Characteristic</i>	Code
Frequency Response (25 ±5°C, A, B, R, –10 dBm input)		
300 kHz to 3 GHz	±1 dB	S-1
3 GHz to 6 GHz	±2 dB	S-1
Ratio Accuracy (A/R, B/R, A/B) (25°C ±5°C, with –10 dBm on all inputs)		
30 kHz to 3 GHz	±0.5 dB	T
3 GHz to 6 GHz	±2.0 dB	T
Trace Noise ⁱ		
30 kHz to 3 GHz	<0.006 dB rms	S-1
3 GHz to 6 GHz	<0.010 dB rms	S-1
Reference Level		
Range	±500 dB	S-3
Resolution	0.001 dB	S-3
<i>Stability</i>		
30 kHz to 3 GHz	0.02 dB/°C	T
3 GHz to 6 GHz	0.04 dB/°C	T
Phase Characteristics (A/R, B/R, A/B)		
Range	±180°	S-3
Display Resolution	0.01°/division	S-3
Marker Resolution ⁱ	0.01°	S-3
Dynamic Accuracy (10 Hz BW, inputs A/R, B/R, A/B; R to –35 dBm)	(see graph)	S-1

Specifications and Regulatory Information
Instrument Specifications (Option 011)

Table 4-2. Agilent 8702E Option 011 Specifications and Characteristics (7 of 8)

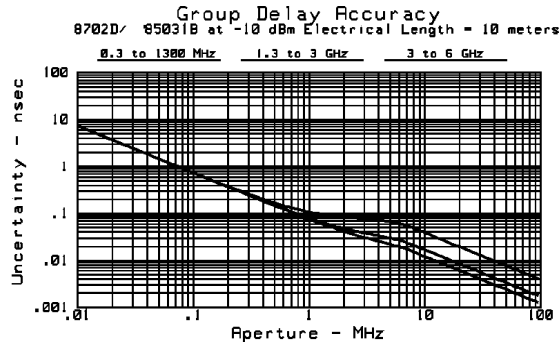
Description	Specification or <i>Characteristic</i>	Code
Dynamic Accuracy (Phase)	<div style="text-align: center;"> <p>DYNAMIC ACCURACY</p> <p>8702D OPT 011 Reference Power = -30 dBm</p> <p>0.3 to 3000 MHz 3 to 6 GHz</p> </div>	
Frequency Response (deviation from linear) (with -10 dBm into inputs, 25°C ±5°C)		
30 kHz to 3 GHz	±3°	S-1
3 GHz to 6 GHz	±10°	S-1
Trace Noise ^j		
30 kHz to 3 GHz	<0.038° rms	S-1
3 GHz to 6 GHz	<0.070° rms	S-1
Reference Level		
Range	±500°	S-3
Resolution	0.01°	S-3
<i>Stability</i>		
30 kHz to 3 GHz	0.05°/degree C	T
3 GHz to 6 GHz	0.20°/degree C	T
Polar Characteristics (Ratio Measurement)		
Range	10 x 10 ⁻¹² up to 1000 units full scale	S-3
Reference	range of ±500 units	S-3
Group Delay Characteristics		

Table 4-2. Agilent 8702E Option 011 Specifications and Characteristics (8 of 8)

Description	Specification or <i>Characteristic</i>	Code
Group delay is computed by measuring the phase change within a specified frequency step (determined by the frequency span and the number of points per sweep).		
Aperture (selectable)	(frequency span)/(number of points – 1)	S-3
Maximum Aperture	20% of frequency span	S-3
Range	1/2 x (1/minimum aperture)	S-3
(The maximum delay is limited to measuring no more than 180° of phase change within the minimum aperture.)		
Accuracy	(see graph)	S-3

The following graph shows group delay accuracy with an Agilent 85047A test set with 7 mm full 2-port calibration and a 10 Hz IF bandwidth. Insertion loss is assumed to be <2 dB and electrical length to be ten meters.

Group Delay Accuracy vs. Aperture



In general, the following formula can be used to determine the accuracy, in seconds, of specific group delay measurement:

$$\pm[0.003 \times \text{Phase Accuracy (deg)}] / \text{Aperture (Hz)}$$

Depending on the aperture and device length, the phase accuracy used is either incremental phase accuracy or worst case phase accuracy.

- Explicitly tested as part of an on-site verification performed by Agilent Technologies.
- Typical 30 kHz to 300 kHz.
- 5 to +13 dBm for Option 006.
- +13 to +18 dBm for Option 006.
- 100 dB, 300 kHz to 16 MHz, due to fixed spurs.
- The Agilent 8702E Option 011 RF source characteristics in this mode are dependent on the stability of the external LO source. The RF source tracks the LO to maintain a stable IF signal at the R channel receiver input. Degradation in accuracy is negligible with an Agilent 8642A/B or Agilent 8568B RF signal generator as the LO source.
- Refer to the Agilent 8702E Option 011 descriptions and options for a functional description.
- Measurement accuracy is dependent on the stability of the input signal.
- Marker resolution for magnitude, phase, and delay is dependent upon the value measured; resolution is limited to 5 digits.
- CW sweep, -10 dBm into receiver, ratio measurement, 3 kHz BW.

Instrument General Characteristics

Table 4-3. Typical Measurement Times

	Typical Time for Completion (ms)			
	Number of Points			
	51	201	401	1601
<i>Measurement</i>				
<i>Uncorrected</i>	125	200	300	900
<i>1-port cal^b</i>	125	200	300	900
<i>2-port cal^b</i>	245	510	855	2940
Time Domain Conversion^c	80	350	740	1790
GPIB Data Transfer^d				
<i>Binary (Internal)</i>	20	35	55	205
<i>IEEE754 floating point format</i>				
<i>32 bit</i>	25	85	150	590
<i>64 bit</i>	40	115	220	840
<i>ASCII</i>	140	510	1000	3960

- a. S_{11} 1-port calibration, with a 3 kHz IF bandwidth. Includes system retrace time, but does not include bandwidth time. Time domain gating is assumed off.
- b. S_{21} measurement with full 2-port calibration, using a 3 kHz IF bandwidth. Includes system retrace time and RF switching time, but does not include bandwidth time. Time domain gating is assumed off.
- c. Option 110 only, gating on.
- d. Measured with HP 9000 series 300 computer.

Table 4-4. Connector Characteristics (1 of 3)

Connector	Characteristic
<i>AUX INPUT Connector</i>	
<i>Input Voltage Limits</i>	<i>-10 V to +10 V</i>
<i>BIAS CONNECT Connector</i>	
<i>Maximum Voltage</i>	<i>+30 Vdc</i>
<i>Maximum Current (no degradation in RF specifications)</i>	<i>±200 mA</i>
<i>Maximum Current</i>	<i>±1 A</i>
<i>EXT AM Connector</i>	
<i>±1 volt into a 5 kΩ resistor, 1 kHz maximum, resulting in approximately 8 dB/volt amplitude modulation.</i>	
<i>EXT MON Connector</i>	
<i>Standard VGA Connector</i>	
<i>EXT REF INPUT Connector</i>	
<i>Frequency</i>	<i>1, 2, 5, and 10 MHz (±200 Hz at 10 MHz)</i>
<i>Level</i>	<i>-10 dBm to +20 dBm, typical</i>
<i>Impedance</i>	<i>50 ohms</i>
<i>LIMIT TEST Connector</i>	
<i>This connector outputs a TTL signal of the limit test results. Pass: TTL high; Fail: TTL low.</i>	
<i>Logic</i>	<i>TTL</i>
<i>PORT 1 and PORT 2 Connectors</i>	
<i>Connector Type</i>	<i>7 mm precision</i>
<i>Impedance</i>	<i>50 ohm (nominal)</i>
<i>Connector Conductor Depth</i>	<i>0.000 to 0.003 in.</i>
<i>A, B, R, RF OUT Connectors (Option 011)</i>	
<i>Connector Type</i>	<i>Type-N, female</i>

Instrument General Characteristics**Table 4-4. Connector Characteristics (2 of 3)**

Connector	Characteristic
<i>Impedance</i>	<i>50 Ω (nominal)</i>
<i>Connector Center Pin Protrusion</i>	<i>0.201 to 0.207 in.</i>
Probe Power Connectors	
<i>+15 V \pm2% 400 mA (combined load for both probe connections).</i>	
<i>-12.6 V \pm5.5% 300 mA (combined load for both probe connections).</i>	
TEST SEQ Connector	
<i>This connector outputs a TTL signal which can be programmed by the user in a test sequence to be high or low. By default, this output provides an end-of-sweep TTL signal. (For use with part handlers.)</i>	
<i>Logic</i>	<i>TTL</i>
<i>DIN Keyboard</i>	
<i>This connector is used for the optional AT-compatible keyboard for titles and front-panel operation.</i>	
GPIB	
<i>This connector allows communication with compatible devices including external controllers, printers, plotters, disk drives, and power meters.</i>	
<i>Option 1D5 10 MHz Frequency Reference</i>	
<i>Frequency</i>	<i>10.0000 MHz</i>
<i>Frequency Stability (0° C to 55° C)</i>	<i>\pm0.05 ppm</i>
<i>Daily Aging Rate (after 30 days)</i>	<i>$\leq 3 \times 10^{-9}$/day</i>
<i>Yearly Aging Rate</i>	<i>0.5 ppm/year</i>
<i>Output</i>	<i>0 dBm minimum</i>
<i>Nominal Output Impedance</i>	<i>50 Ω</i>
Parallel Port	
<i>This connector is used with parallel (or Centronics interface) peripherals, such as printers and plotters. It can also be used as a general purpose I/O port, with control provided by test sequencing functions.</i>	

Table 4-4. Connector Characteristics (3 of 3)

Connector	Characteristic
RS-232	<i>This connector is used with serial peripherals, such as printers and plotters.</i>

EXT TRIG Connector

Triggers on a negative TTL transition or contact closure to ground.

External Trigger Circuit

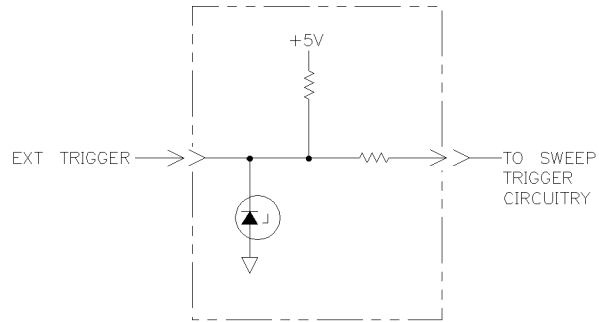


Table 4-5. Internal Memory Data Retention Time with 3 V, 1.2 Ah Battery

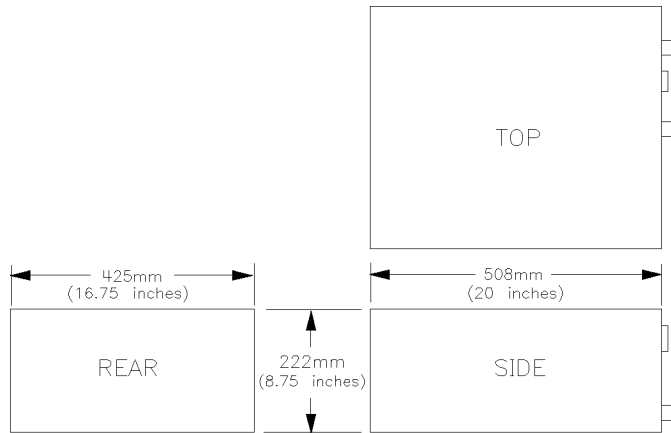
Temperature	Retention Time
70°C	250 days (0.68 year)
40°C	1244 days (3.4 years)
25°C	11904 days (32.6 years) typical

Environmental Characteristics

Environmental Characteristics

Table 4-6. Operating Characteristics

<i>Use</i>	<i>Indoor</i>
<i>Power</i>	<i>280 VA maximum</i>
<i>Voltage</i>	<i>nominal: 115 VAC / 230 VAC range 115 VAC: 90–132 V range 230 VAC: 198–264 V</i>
<i>Frequency</i>	<i>nominal: 50 Hz / 60 Hz range: 48-66 Hz</i>
<i>Operating Conditions</i> <i>Operating temperature:</i> <i>Error-correction temperature range:</i> <i>Humidity:</i> <i>Altitude:</i>	<i>0° to 55° C ±1° C of calibration temperature 5% to 95% at 40° C (non-condensing) 0 to 4500 meters (15,000 feet)</i>
<i>Non-Operating Storage Conditions</i> <i>Temperature range:</i> <i>Humidity:</i> <i>Altitude:</i>	<i>–40° C to +70° C 0 to 90% relative at +65° C (non-condensing) 0 to 15,240 meters (50,000 feet)</i>
<i>Weight</i>	<i>Net: 34 kg (75 lb) Shipping: 37 kg (82 lb)</i>
<i>Dimensions (H x W x D)</i>	<i>222 x 425 x 508 mm (8.75 x 16.75 x 20.0 in) These dimensions exclude front and rear panel protrusions.</i>



pg6 14

Dimensions of the instrument

System E/E Characteristics

System E/E Characteristics

The characteristics listed in this section apply to Agilent 8702E instruments with specific options, calibration kits, and cables.

Agilent 8702E (50Ω) with 7 mm Test Ports

The system hardware includes the following:

Options:006

Calibration kit:Agilent 85031B

Cables:Agilent 11857D

**MEASUREMENT PORT CHARACTERISTICS (CORRECTED)^a
for Agilent 8702E (50Ω) with 7 mm Test Ports**

	Frequency Range			
	30 kHz to 300 kHz ^b	300 kHz to 1.3 GHz	1.3 GHz to 3 GHz	3 GHz to 6 GHz
Directivity	55 dB	55 dB	51 dB	46 dB
Source Match	55 dB	51 dB	49 dB	43 dB
Load Match	55 dB	55 dB	51 dB	46 dB
Reflection Tracking	± 0.001 dB	± 0.001 dB	± 0.005 dB	± 0.020 dB
Transmission Tracking	± 0.008 dB	± 0.006 dB	± 0.009 dB	± 0.021 dB

a. These characteristics apply for an environmental temperature of $25 \pm 5^\circ\text{C}$, with less than 1°C deviation from the calibration temperature.

b. Typical Performance

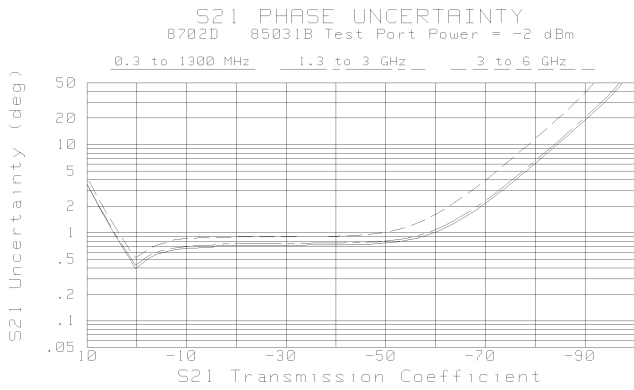
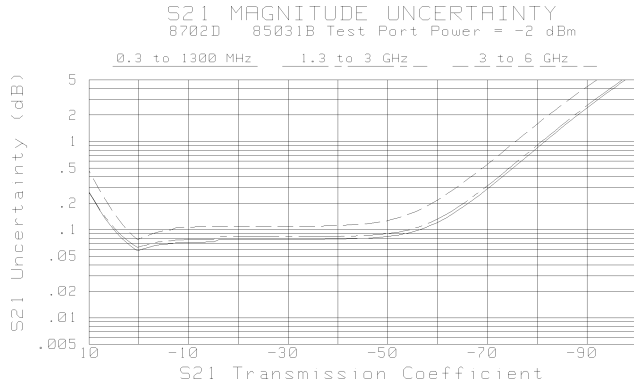
MEASUREMENT PORT CHARACTERISTICS (UNCORRECTED)^a
for Agilent 8702E (50Ω) with 7 mm Test Ports

	Frequency Range			
	30 kHz to 300 kHz ^b	300 kHz to 1.3 GHz	1.3 GHz to 3 GHz	3 GHz to 6 GHz
Directivity	20 dB ^c	35 dB	30 dB	25 dB
Source Match	18 dB ^d	16 dB	16 dB	14 dB
Load Match	20 dB ^d	18 dB	16 dB	14 dB
Reflection Tracking	± 2.0 dB	± 1.5 dB	± 1.5 dB	± 2.5 dB
Transmission Tracking	± 2.0 dB	± 1.5 dB	± 1.5 dB	± 2.5 dB
Crosstalk	90 dB	100 dB	100 dB	90 dB

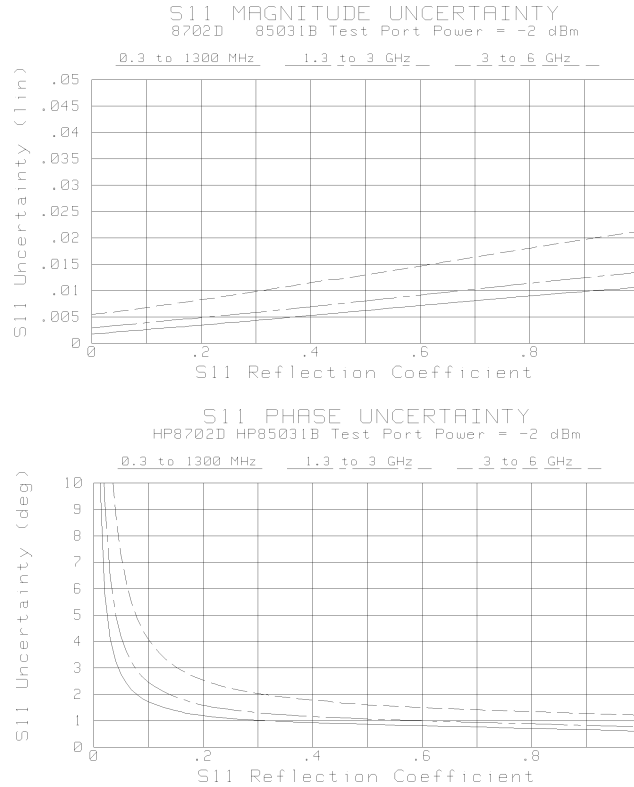
- a. Applies at 25 \pm 5°C
b. Typical Performance
c. 10 dB, 30 kHz to 50 kHz
d. 15 dB, 30 kHz to 50 kHz

System E/E Characteristics

Transmission Measurement Uncertainties



Reflection Measurement Uncertainties



Agilent 8702E (50Ω) with Type-N Test Ports

The system hardware includes the following:

Options: 006
 Calibration kit: Agilent 85032B/E
 Cables: Agilent 11851B

System E/E Characteristics

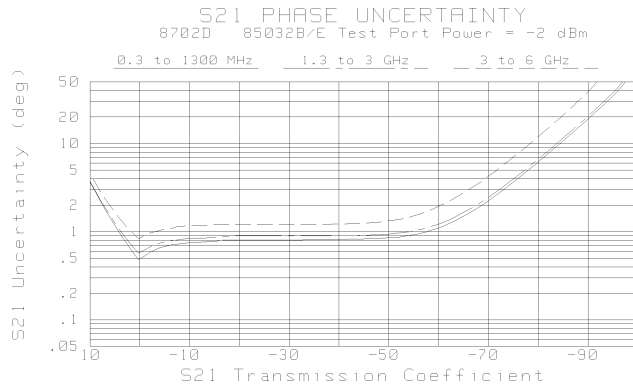
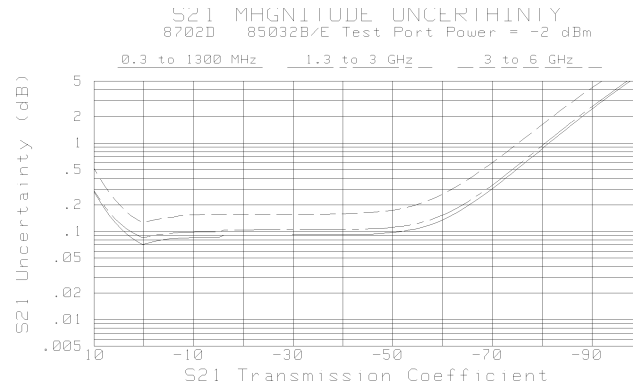
**MEASUREMENT PORT CHARACTERISTICS (CORRECTED)^a
for Agilent 8702E (50Ω) with Type-N Test Ports**

	Frequency Range			
	30 kHz to 300 kHz ^b	300 kHz to 1.3 GHz	1.3 GHz to 3 GHz	3 GHz to 6 GHz
Directivity	50 dB	50 dB	47 dB	40 dB
Source Match	49 dB	42 dB	36 dB	31 dB
Load Match	50 dB	50 dB	47 dB	40 dB
Reflection Tracking	± 0.005 dB	± 0.009 dB	± 0.019 dB	± 0.070 dB
Transmission Tracking	± 0.014 dB	± 0.013 dB	± 0.026 dB	± 0.065 dB

a. Applies at 25 ±5°C

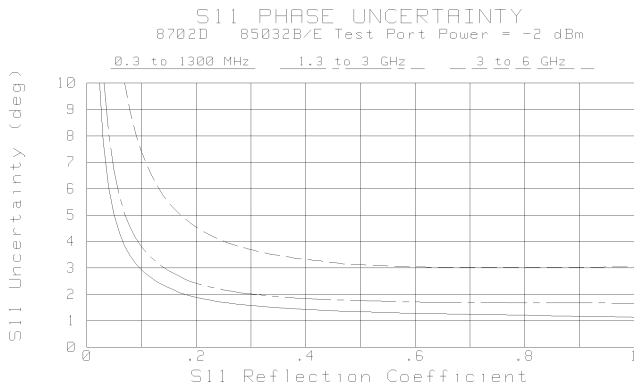
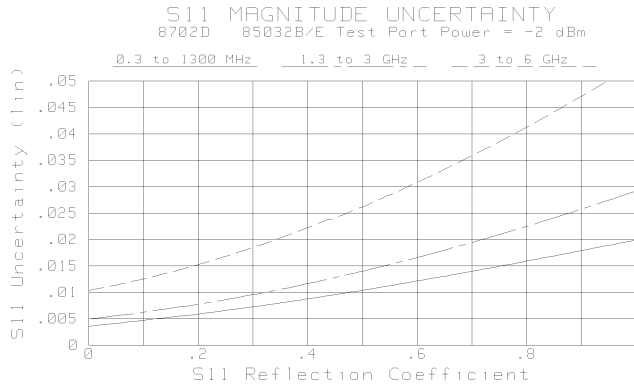
b. Typical Performance

Transmission Measurement Uncertainties



System E/E Characteristics

Reflection Measurement Uncertainties



Agilent 8702E (50Ω) with 3.5 mm Test Ports

The system hardware includes the following:

Options: 006
 Calibration kit: Agilent 85033D
 Cables: Agilent 11857D

MEASUREMENT PORT CHARACTERISTICS (CORRECTED)^a for Agilent 8702E (50Ω) with 3.5 mm Test Ports

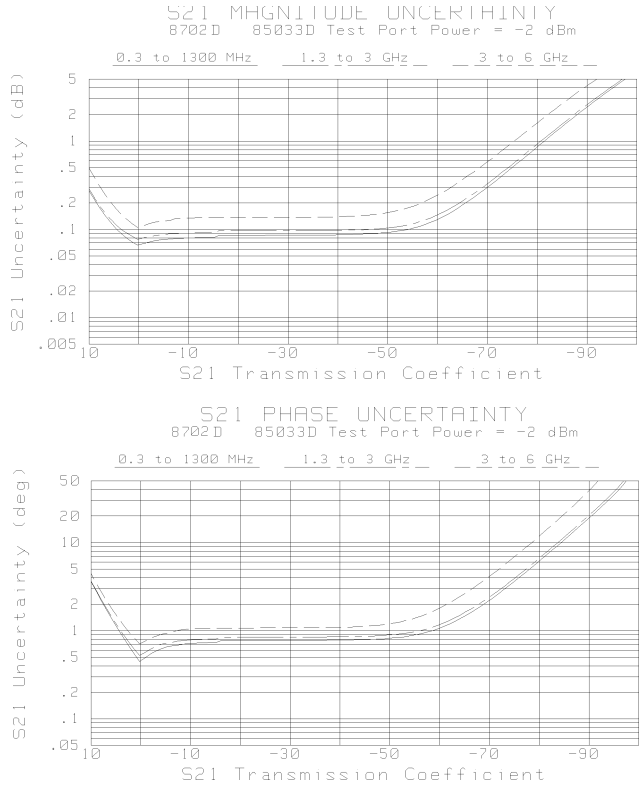
	Frequency Range			
	30 kHz to 300 kHz^b	300 kHz to 1.3 GHz	1.3 GHz to 3 GHz	3 GHz to 6 GHz
Directivity	49 dB	46 dB	44 dB	38 dB
Source Match	49 dB	44 dB	41 dB	37 dB
Load Match	49 dB	46 dB	44 dB	38 dB
Reflection Tracking	<i>±0.010 dB</i>	<i>±0.005 dB</i>	<i>±0.007 dB</i>	<i>±0.009 dB</i>
Transmission Tracking	<i>±0.016 dB</i>	<i>±0.014 dB</i>	<i>±0.022 dB</i>	<i>±0.048 dB</i>

a. Applies at 25 ±5°C

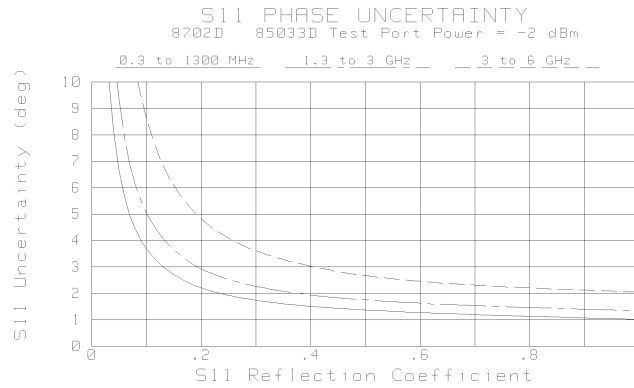
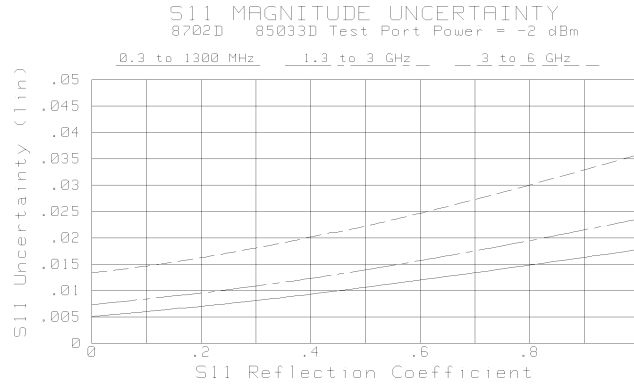
b. Typical Performance

System E/E Characteristics

Transmission Measurement Uncertainties



Reflection Measurement Uncertainties



System E/E Characteristics

Agilent 8702E (75Ω) with Type-N Test Ports

The system hardware includes the following:

Options:075
 Calibration kit:Agilent 85036B
 Cables:Agilent 11857B

**MEASUREMENT PORT CHARACTERISTICS (CORRECTED)^a
 for Agilent 8702E (75Ω) with Type-N Test Ports**

	Frequency Range		
	30 kHz to 300 kHz ^b	300 kHz to 1.3 GHz	1.3 GHz to 3 GHz
Directivity	48 dB	48 dB	43 dB
Source Match	47 dB	41 dB	35 dB
Load Match	48 dB	48 dB	43 dB
Reflection Tracking	± 0.004 dB	± 0.010 dB	± 0.019 dB
Transmission Tracking	± 0.018 dB	± 0.015 dB	± 0.033 dB

- a. Applies at 25 ±5°C
- b. Typical Performance

**MEASUREMENT PORT CHARACTERISTICS (UNCORRECTED)^a
 for Agilent 8702E (75Ω) with Type-N Test Ports**

	Frequency Range		
	30 kHz to 300 kHz ^b	300 kHz to 1.3 GHz	1.3 GHz to 3 GHz
Directivity	34 dB	35 dB	30 dB
Source Match	10 dB	16 dB	16 dB
Load Match	14 dB	18 dB	16 dB

MEASUREMENT PORT CHARACTERISTICS (UNCORRECTED)^a
for Agilent 8702E (75Ω) with Type-N Test Ports

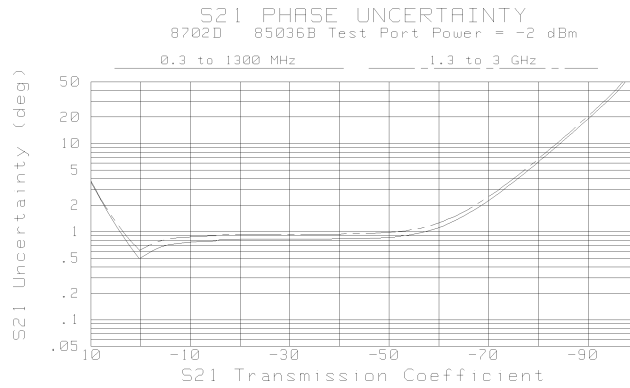
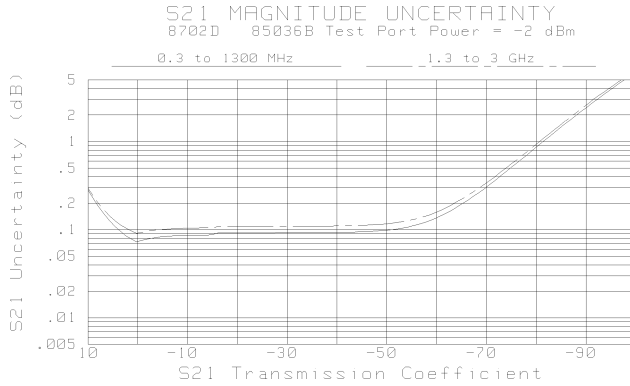
	Frequency Range		
	30 kHz to 300 kHz^b	300 kHz to 1.3 GHz	1.3 GHz to 3 GHz
Reflection Tracking	± 2.0 dB	± 1.5 dB	± 1.5 dB
Transmission Tracking	± 2.0 dB	± 1.5 dB	± 1.5 dB
Crosstalk	100 dB	100 dB	100 dB

a. Applies at 25 \pm 5°C

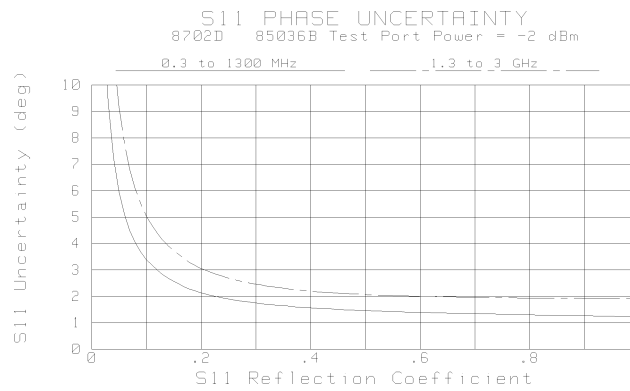
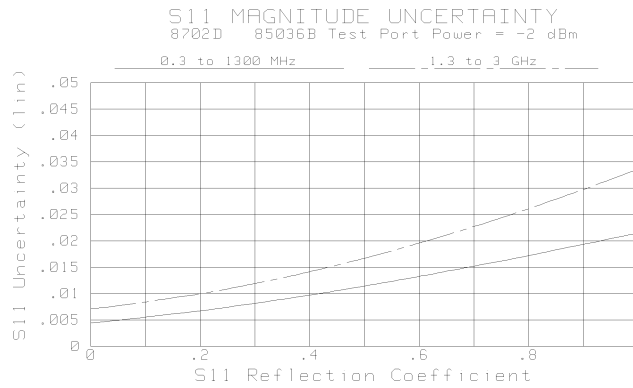
b. Typical Performance

System E/E Characteristics

Transmission Measurement Uncertainties



Reflection Measurement Uncertainties



System E/E Characteristics

Agilent 8702E (75Ω) with Type-F Test Ports

The system hardware includes the following:

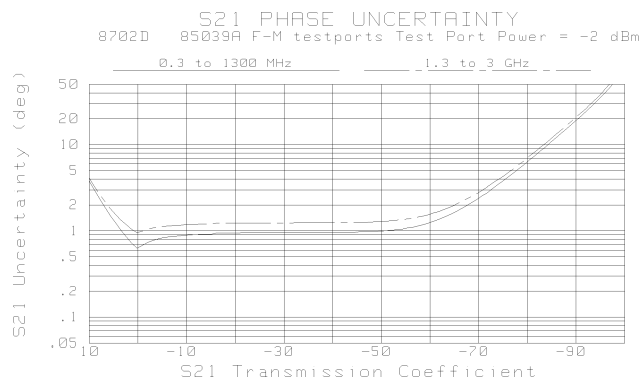
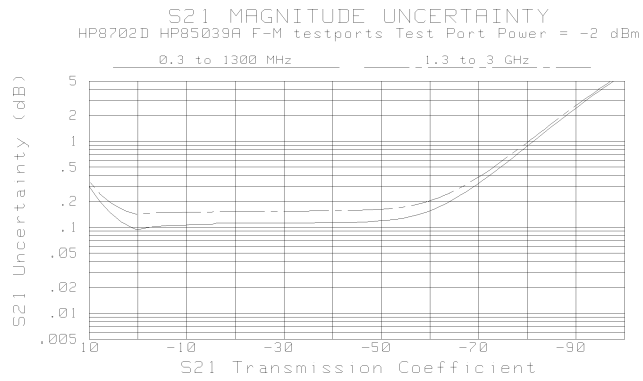
Options:075
 Calibration kit:Agilent 85039A
 Cables:Agilent 11857B

**MEASUREMENT PORT CHARACTERISTICS (CORRECTED)^a
 for Agilent 8702E (75Ω) with Type-F Test Ports**

	Frequency Range		
	30 kHz to 300 kHz ^b	300 kHz to 1.3 GHz	1.3 GHz to 3 GHz
Directivity	38 dB	38 dB	32 dB
Source Match	36 dB	36 dB	30 dB
Load Match	38 dB	38 dB	32 dB
Reflection Tracking	± 0.0080 dB	± 0.0080 dB	± 0.0320 dB
Transmission Tracking	± 0.0618 dB	± 0.0346 dB	± 0.0778 dB

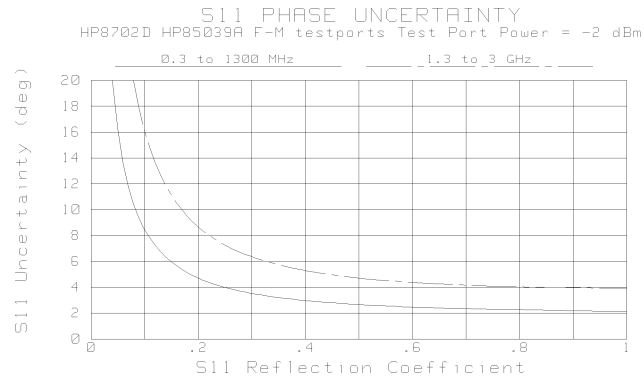
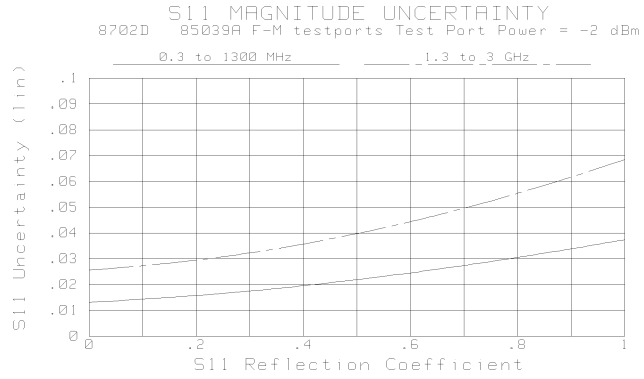
- a. Applies at 25 ±5°C
- b. Typical Performance

Transmission Measurement Uncertainties



System E/E Characteristics

Reflection Measurement Uncertainties



Agilent 8702E (75Ω) using Agilent 85039A F-F Test Ports**MEASUREMENT PORT CHARACTERISTICS (CORRECTED)^a
for Agilent 8702E (75Ω) using Agilent 85039A F-F Test Ports**

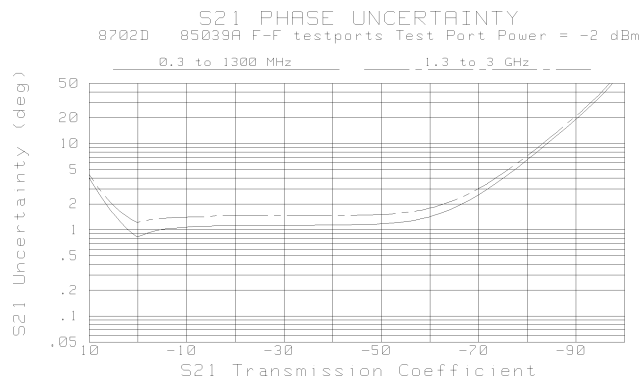
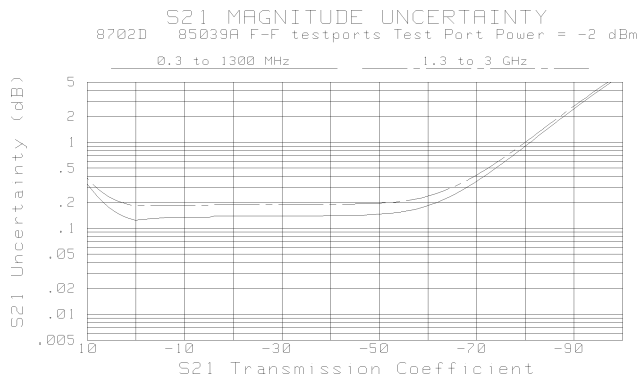
	Frequency Range		
	30 kHz to 300 kHz ^b	300 kHz to 1.3 GHz	1.3 GHz to 3 GHz
Directivity	38 dB	38 dB	32 dB
Source Match	36 dB	36 dB	30 dB
Load Match	29.8 dB	29.8 dB	26 dB
Reflection Tracking	± 0.0080 dB	± 0.0080 dB	± 0.0320 dB
Transmission Tracking	± 0.1161 dB	± 0.0619 dB	± 0.1118 dB

a. Applies at 25 ±5°C

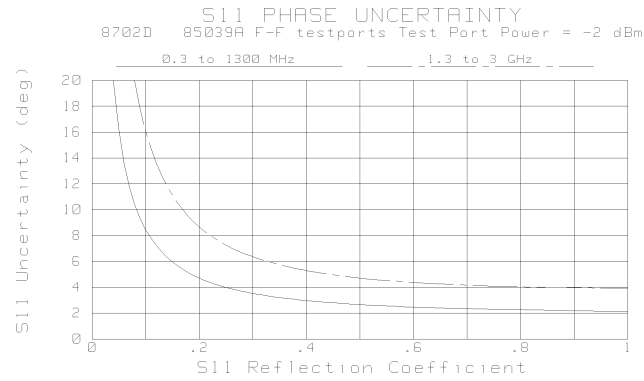
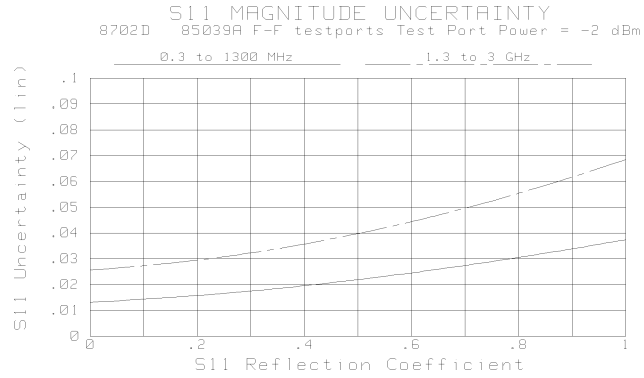
b. Typical Performance

System E/E Characteristics

Transmission Measurement Uncertainties



Reflection Measurement Uncertainties



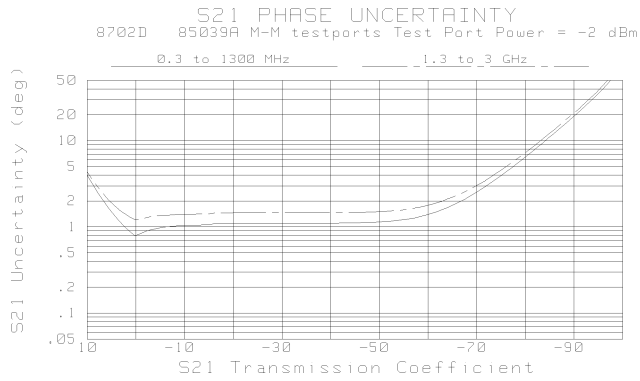
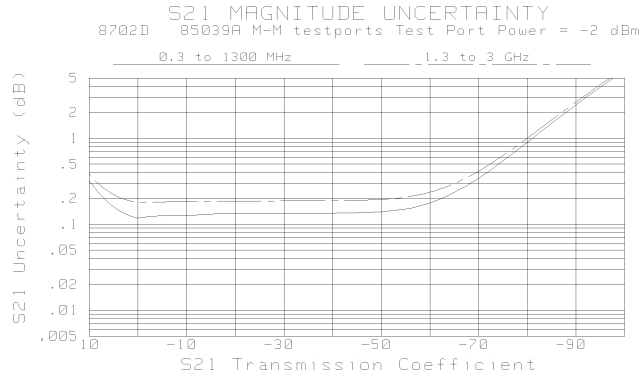
System E/E Characteristics**Agilent 8702E (75Ω) using Agilent 85039A M-M Test Ports****MEASUREMENT PORT CHARACTERISTICS (CORRECTED)^a
for Agilent 8702E (75Ω) using Agilent 85039A M-M Test Ports**

	Frequency Range		
	30 kHz to 300 kHz ^b	300 kHz to 1.3 GHz	1.3 GHz to 3 GHz
Directivity	29.8 dB	29.8 dB	26 dB
Source Match	29 dB	29 dB	25 dB
Load Match	38 dB	38 dB	32 dB
Reflection Tracking	± 0.0425 dB	± 0.0354 dB	± 0.0728 dB
Transmission Tracking	± 0.0961 dB	± 0.0563 dB	± 0.1106 dB

a. Applies at 25 ±5°C

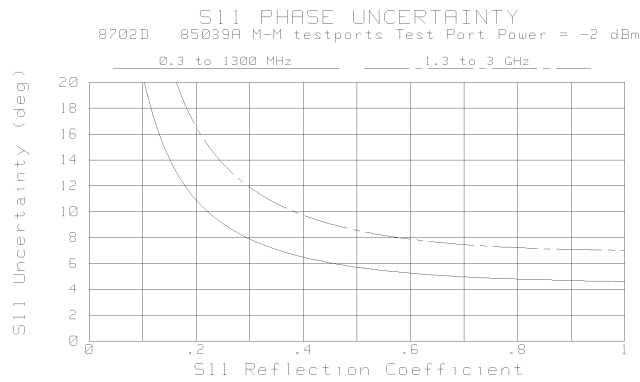
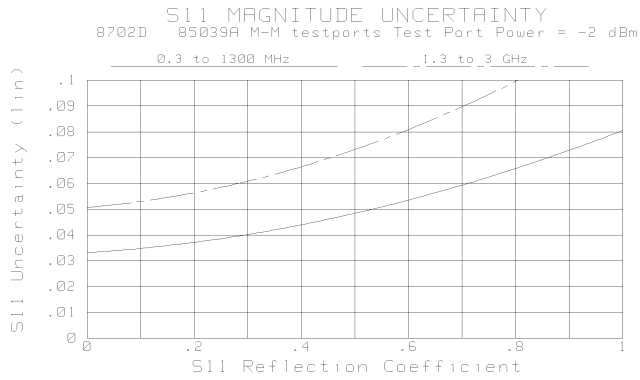
b. Typical Performance

Transmission Measurement Uncertainties



System E/E Characteristics

Reflection Measurement Uncertainties



Agilent 8702E (75Ω) using Agilent 85039A M-F Test Ports**MEASUREMENT PORT CHARACTERISTICS (CORRECTED)^a
for Agilent 8702E (75Ω) using Agilent 85039A M-F Test Ports**

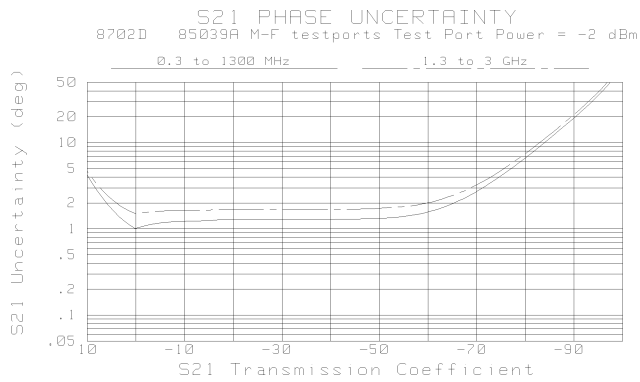
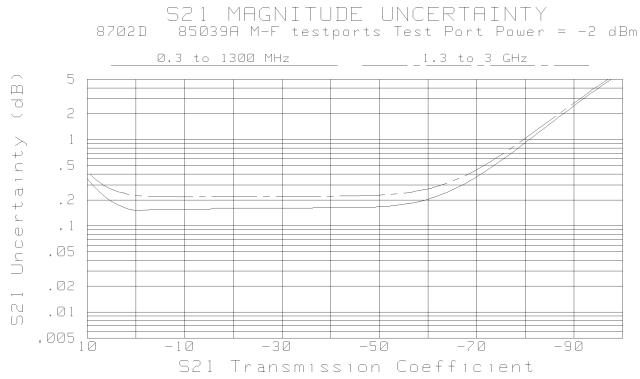
	Frequency Range		
	30 kHz to 300 kHz ^b	300 kHz to 1.3 GHz	1.3 GHz to 3 GHz
Directivity	29.8 dB	29.8 dB	26 dB
Source Match	29 dB	29 dB	25 dB
Load Match	29.8 dB	29.8 dB	26 dB
Reflection Tracking	± 0.0425 dB	± 0.0354 dB	± 0.0728 dB
Transmission Tracking	± 0.1502 dB	± 0.0836 dB	± 0.1445 dB

a. Applies at 25 ±5°C

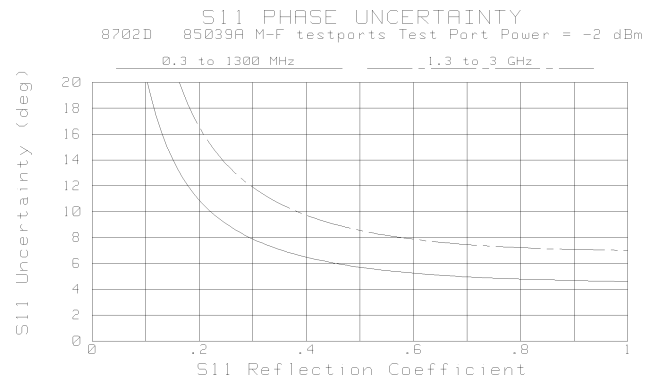
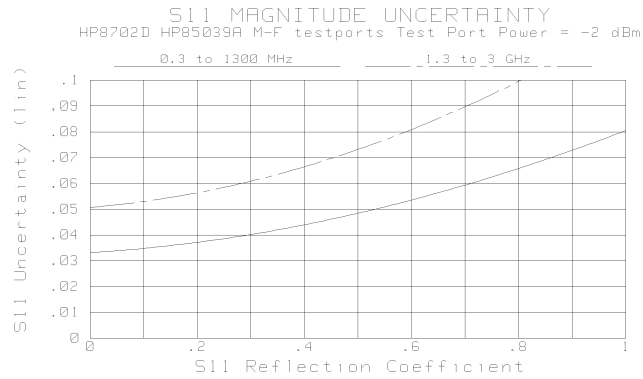
b. Typical Performance

System E/E Characteristics

Transmission Measurement Uncertainties



Reflection Measurement Uncertainties



System Characteristics

What you'll find in this section

System O/E Characteristics 4-53

3 GHz and 6 GHz 50 Ω System Configuration 4-54

3 GHz and 6 GHz 50 Ω System Configuration for Agilent 8702E Option 011 and Agilent 11889A RF Interface Kit 4-59

3 GHz and 6 GHz 75 Ω System Configuration 4-65

System E/O Characteristics 4-68

3 GHz and 6 GHz 50 Ω System Configuration 4-69

3 GHz and 6 GHz 50 Ω System Configuration for Agilent 8702E Option 011 and Agilent 11889A RF Interface Kit 4-74

3 GHz and 6 GHz 75 Ω System Configuration 4-80

System O/O Characteristics 4-83

3 GHz and 6 GHz 50 Ω System Configuration 4-83

3 GHz and 6 GHz 50 Ω System Configuration for Agilent 8702E Option 011 and Agilent 11889A RF Interface Kit 4-88

Lightwave Receiver Measurement Repeatability 4-94

Typical System Performance (measurement uncertainty)

These are a set of curves, or plots, that describe the measurement accuracy characteristics of the lightwave component analyzer system under certain conditions. These curves can be used to assign a value of uncertainty (± 3 dB value) to your measurements based upon the RF modulation frequency, device under test return loss, or other device under test parameters. In addition, several other plots are shown to further describe measurement repeatability and the Agilent Technologies lightwave source (laser) reflection sensitivity.

The following curves and descriptions apply to 3 GHz and 6 GHz (Option 006) systems at 1300 nm and 1550 nm for mostly single-mode fiber devices. Some curves have been included for 850 nm multi-mode fiber devices. Refer to the measurement type listed in the contents, then to the specific plot configuration and its assumptions or conditions. The plot can then be used to determine the uncertainty characteristic of your device measurement.

All curves are based upon measurements using an Agilent 8702E system as shown for each configuration below. The assumptions (conditions) given with each plot describe the type of calibration required, the RF input power level, and the device under test insertion or return loss.

Definitions***Input power***

This is the RF modulation power (dBm) delivered to the lightwave source's electrical input. An Agilent 8702E delivers +10 dBm input power when +10 dBm is selected on the analyzer's RF power menu. After transmission path attenuation, an Agilent 8702E Option 011 will deliver +14 dBm input power when +20 dBm is selected on the analyzer's RF power menu.

Return loss

This is the amount of signal power reflecting off or returning from a device, compared to the incident signal. Return loss is expressed as a linear reflection coefficient (ρ) or a dB value. Because the analyzer display is often logarithmic, return loss (RL) is expressed in dB. The return loss of your device under test can be measured by making an optical reflection measurement, explained in the *Agilent 8702E User's Guide*. For example, a 3.5% Fresnel reflection is -14.6 dB where:

$$\begin{aligned} \text{RL} &= +10 \log \text{Reflected Power/Incident Power} \\ \text{RL} &= +10 \log 3.5\%/100\% \\ \text{RL} &= +10 \log 0.035 \\ \text{RL} &= -14.6 \text{ dB} \end{aligned}$$

Insertion loss

This is the amount of signal power (dB) dissipated in a device, compared to the incident signal inserted into the device. The loss is usually due to the attenuation of the device as the signal passes through it. For example, if a 10 dBm signal is injected into a device under test and 7 dBm is measured as its output, then insertion loss is 3 dB.

Reflection sensitivity

This is a measure of the lightwave source's sensitivity to reflected light entering the laser cavity.

Typical Example***How to determine your flatness measurement uncertainty***

Suppose you were measuring the responsivity of a 1550 nm receiver and wanted to know the flatness accuracy from 300 kHz to 3 GHz. You would perform a response & match calibration for an O/E device (explained in the *Agilent 8702E User's Guide*). You would then measure the receiver to determine the response (in dB) at some frequency between 300 kHz and 3 GHz. You would refer to the O/E transmission measurement plot, [Figure 4-2 on page 4-55](#). Using the plot, you would locate the measured O/E responsivity (in dB) on the trace that represents the source and receiver pair used to calibrate the measurement (Agilent 83411C). In this example, the receiver's responsivity is -10 dB at 3 GHz. Assuming that the receiver electrical port return loss is 14 dB_e, optical port return loss is 30 dB_o, and the RF input power to the light-

System Characteristics

wave source (Agilent 83403C) is +10 dBm, the curve shows that at -10 dB measured responsivity, the flatness uncertainty is ± 0.35 dB. Therefore, if the 3 GHz modulation point value showed -10 dB on the display of the analyzer, the measurement would have a total flatness uncertainty window of -10.35 dB to -9.65 dB. The flatness uncertainty window in A/W would be 0.30 A/W to 0.33 A/W for a measured value of 0.32 A/W. (This uncertainty number does not consider optical connector loss uncertainty. A typical absolute uncertainty value can be calculated by adding ± 0.76 dBe to the -10.35 dB to -9.65 dB flatness uncertainty window in this example.)

System O/E Characteristics

Measurements of O/E devices with optical inputs and electrical outputs have a total value of uncertainty that includes various individual uncertainties. The total relative measurement uncertainty (dB) is shown plotted against the device under test responsivity (dB). These graphs refer to the relative flatness of modulation bandwidth measurements.

Included in the total relative uncertainty value (shown by the plots) are the following individual contributing uncertainties:

- Drift with temperature ($23 \pm 3^\circ\text{C}$)
- Dynamic accuracy
- Reflection sensitivity
- Wavelength accuracy
- Factory test (characterization) system
- Electrical mismatches or reflections between:
 - RF source/lightwave source RF input
 - RF receiver/lightwave receiver RF output
- Optical mismatches or reflections between:
 - lightwave source/lightwave receiver
 - lightwave source/device under test

Absolute magnitude uncertainty includes additional error contributors, the greatest of which is optical connector loss uncertainty. A typical absolute uncertainty value for a specific data point can be calculated by adding ± 0.76 dB to the value found on the uncertainty graphs.

The responsivity of an O/E device can be read off the display in dB or linear units for any given frequency. The *Agilent 8702E User's Guide* describes how to convert the dB value to its corresponding amps/watt responsivity value in the example for measuring an O/E converter where,

$$\text{Responsivity } R \text{ (dB)} = 20 \log_{10} [R \text{ (a/w)} / 1 \text{ (a/w)}]$$

System O/E Characteristics

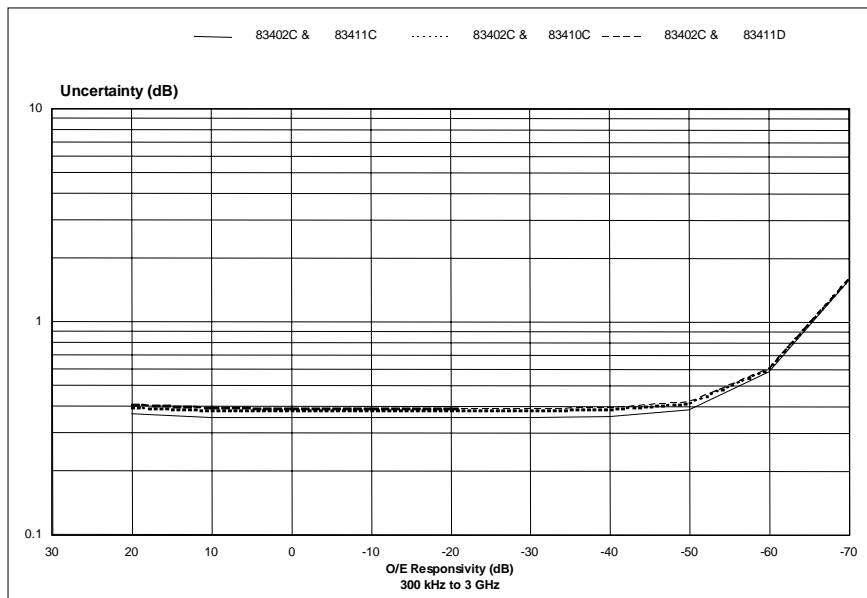
3 GHz and 6 GHz 50 Ω System Configuration

The following plots are based on an Agilent 8702E system consisting of the following:

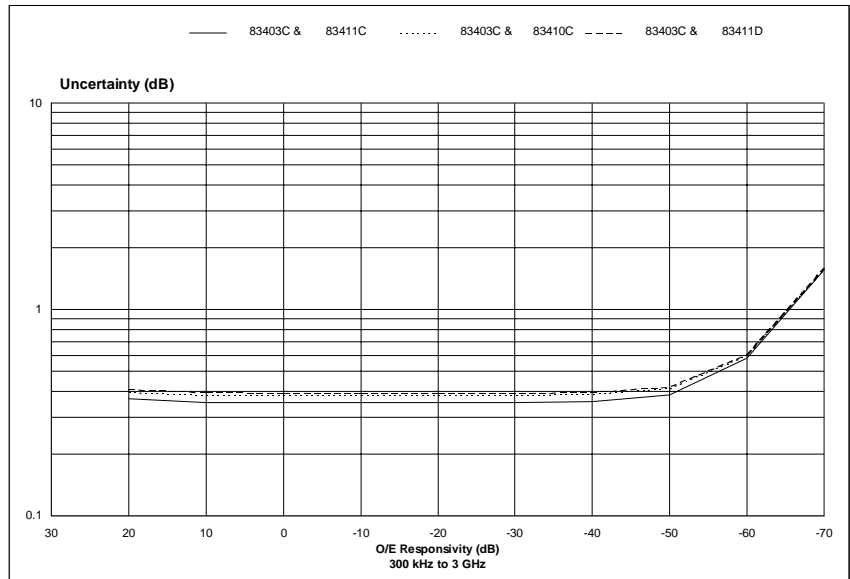
- Agilent 8702E (standard) for 300 kHz to 3 GHz modulation bandwidth, *or* Agilent 8702E Option 006 (6 GHz frequency extension) for 3 GHz to 6 GHz modulation bandwidth
- Agilent 8340XX SMF Lightwave Source
- Agilent 8341XX Lightwave Receiver
- Agilent 11886A Interconnect Cable Kit (HMS-10)
- Agilent 11857D 50 Ω 7 mm Test Port Return Cables
- Agilent 85033D 3.5 mm Calibration Kit

Assumptions or Conditions

- Receiver response & match calibration using disk data for the Agilent 8341XX selected
- Device under test optical input return loss = 30 dB_o
- Device under test electrical output return loss = 14 dB_e
- RF input power to the lightwave source = +10 dBm

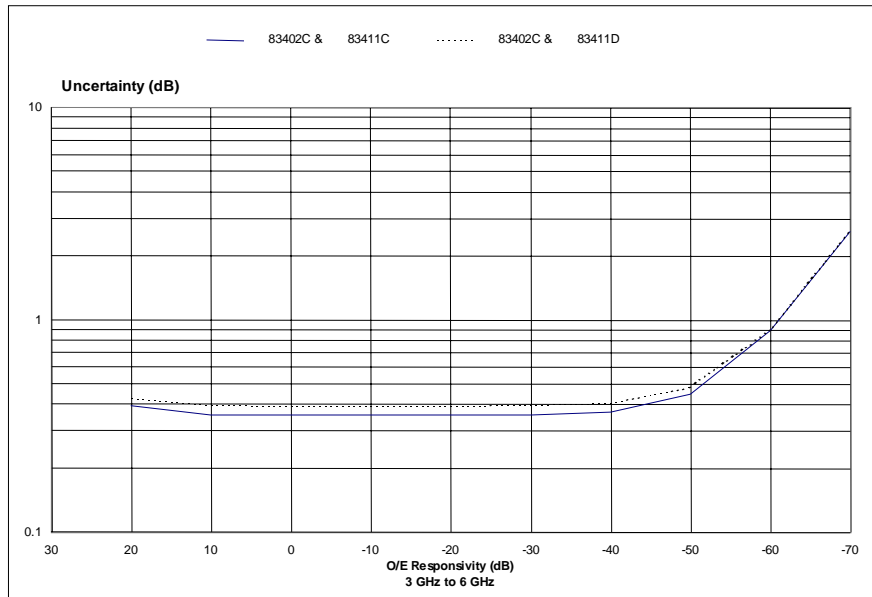


**Figure 4-1. Slope Responsivity Uncertainty vs. O/E Responsivity
300 kHz to 3 GHz (*characteristic*)**

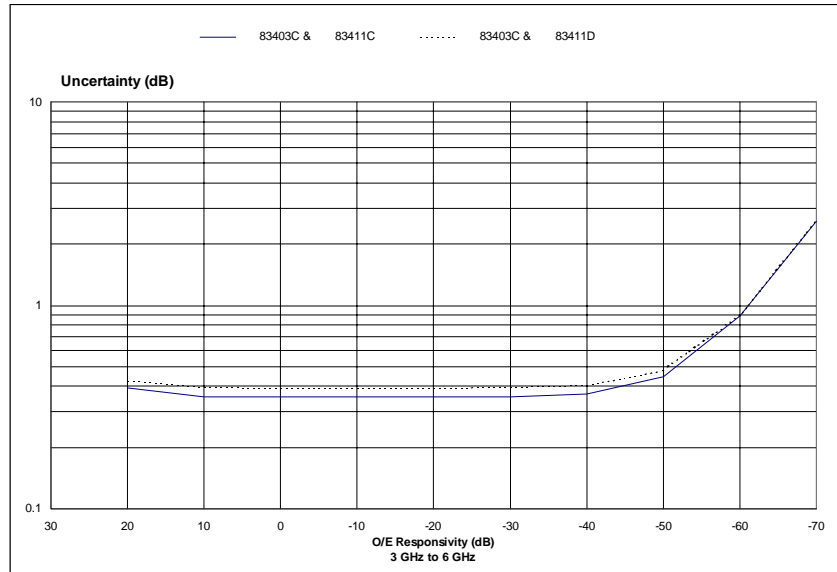


**Figure 4-2. Slope Responsivity Uncertainty vs. O/E Responsivity
300 kHz to 3 GHz (*characteristic*)**

System O/E Characteristics



**Figure 4-3. Slope Responsivity Uncertainty vs. O/E Responsivity
3 GHz to 6 GHz (*characteristic*)**



**Figure 4-4. Slope Responsivity Uncertainty vs. O/E Responsivity
3 GHz to 6 GHz (*characteristic*)**

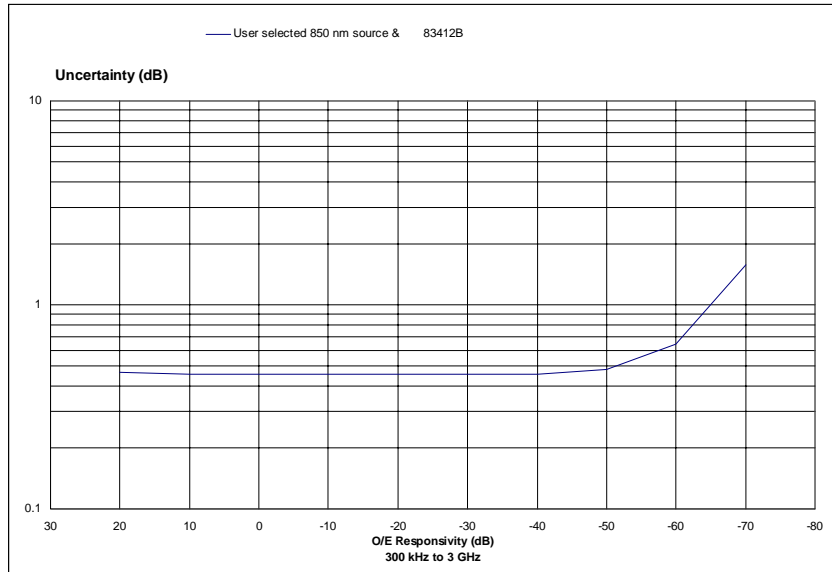
The following plot is based on an Agilent 8702E system for 850 nm measurements consisting of the following:

- Agilent 8702E (standard) for 300 kHz to 3 GHz modulation bandwidth
- User-selected 850 nm source with the following characteristics:
 - Electrical input return loss = 14 dB_e
 - Optical output return loss = 34 dB_o
 - Responsivity = -26 dB_e
- Agilent 83412B 850 nm Lightwave Receiver
- Agilent 11887A Interconnect Cable Kit (HMS-10)
- Agilent 11857D 50Ω 7 mm Test Port Return Cables
- Agilent 85033D Calibration Kit

Assumptions or Conditions

- Receiver response & match calibration using disk data for the Agilent 83412B
- Device under test optical input return loss = 30 dB_o
- Device under test electrical output return loss = 14 dB_e
- RF input power to the lightwave source = +10 dBm

System O/E Characteristics



**Figure 4-5. Slope Responsivity Uncertainty vs. O/E Responsivity
300 kHz to 3 GHz (*characteristic*)**

The two curves in the following plot show the uncertainty in a measurement of deviation from linear phase response after the average group delay has been removed for 3 GHz and 6 GHz measurements. Locate the device under test's responsivity in dB along the X axis. For modulation frequencies between 300 kHz and 3 GHz, read the uncertainty value off the Y axis that corresponds to the 3 GHz curve. For modulation frequencies between 3 GHz and 6 GHz, read the uncertainty value corresponding to the 6 GHz curve.

Assumptions or Conditions

- Receiver response & match calibration using disk data for the Agilent 8341XX selected
- Device under test optical input return loss = 30 dB_o
- Device under test electrical output return loss = 14 dB_e
- RF input power to the lightwave source = +10 dBm

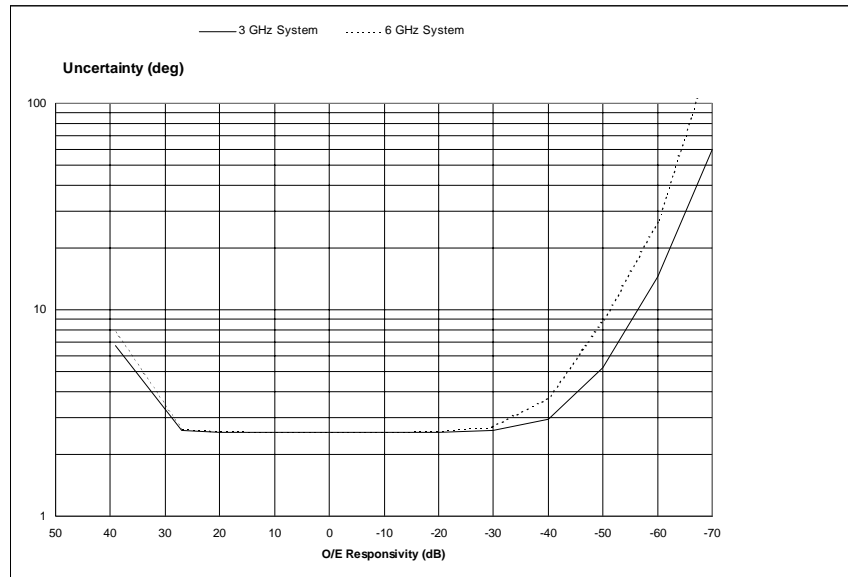


Figure 4-6. Deviation from Linear Phase vs. O/E Responsivity (*characteristic*)

3 GHz and 6 GHz 50 Ω System Configuration for Agilent 8702E Option 011 and Agilent 11889A RF Interface Kit

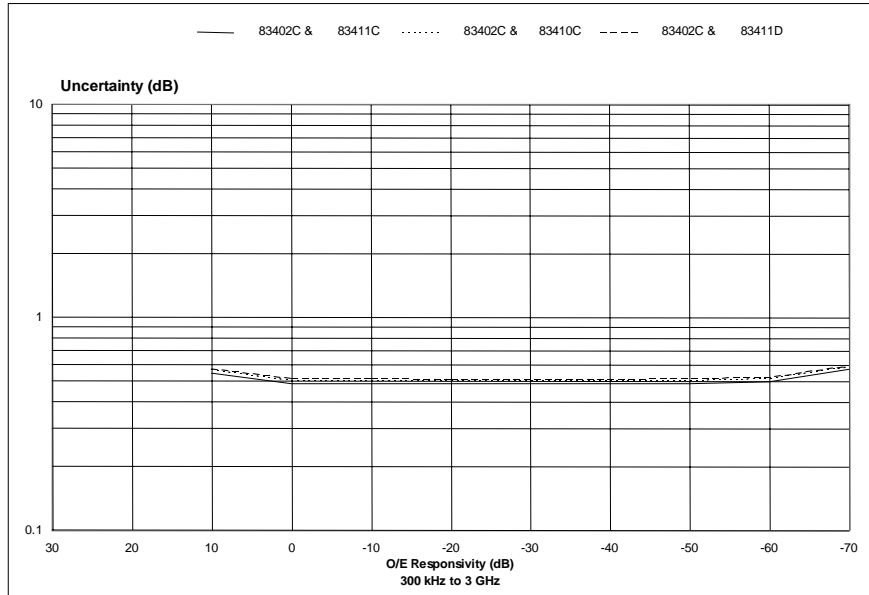
The following plots are based on an Agilent 8702E Option 011 system consisting of the following:

- Agilent 8702E Option 011 for 300 kHz to 3 GHz modulation bandwidth, *or* Agilent 8702E Option 011, 006 (6 GHz Frequency Extension) for 3 GHz to 6 GHz modulation bandwidth
- Agilent 8340XX SMF Lightwave Source
- Agilent 8341XX Lightwave Receiver
- Agilent 11886A Interconnect Cable Kit (HMS-10)
- Agilent 11889A RF Interface Kit

System O/E Characteristics

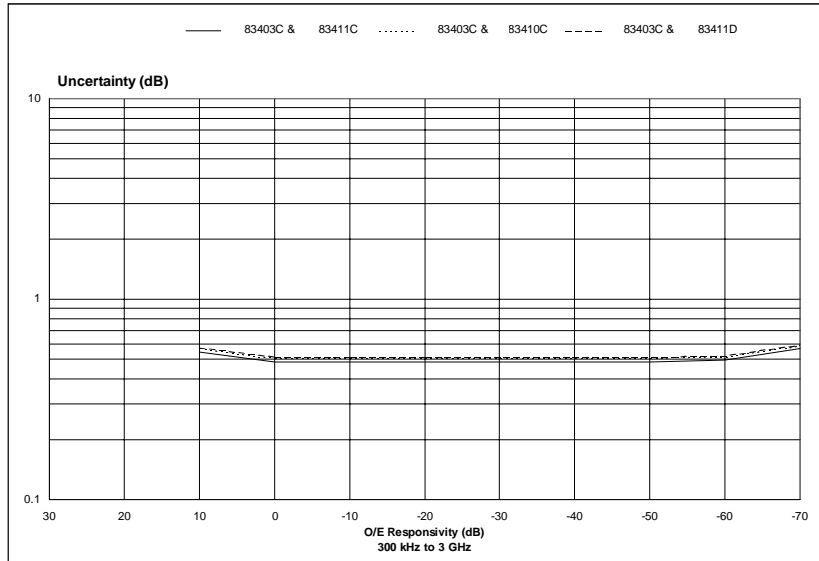
Assumptions or Conditions

- Receiver response calibration using disk data for the Agilent 8341XX selected
- Device under test optical input return loss = 30 dBo
- Device under test electrical output return loss = 14 dB
- RF input power to the lightwave source = +10 dBm



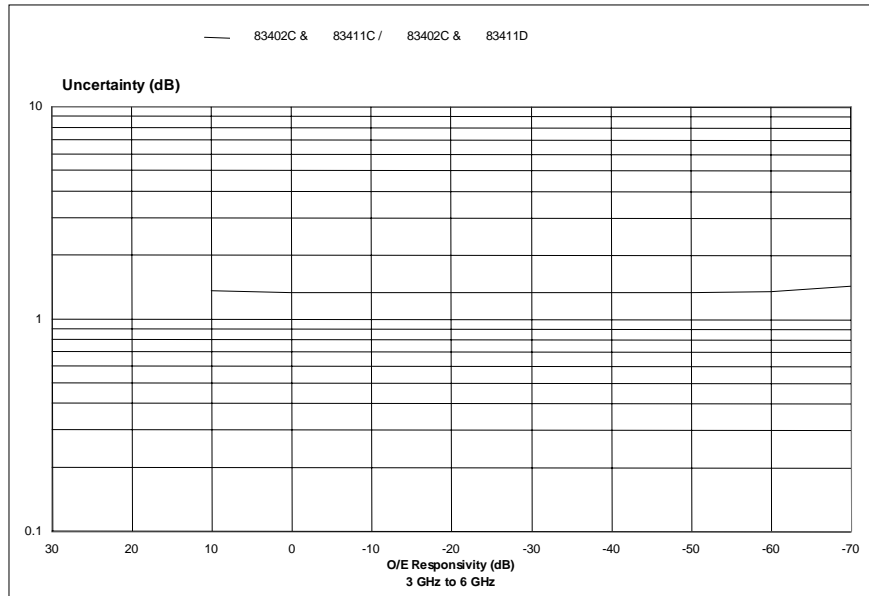
**Figure 4-7. Slope Responsivity Uncertainty vs. O/E Responsivity
300 kHz to 3 GHz (*characteristic*)**

System O/E Characteristics

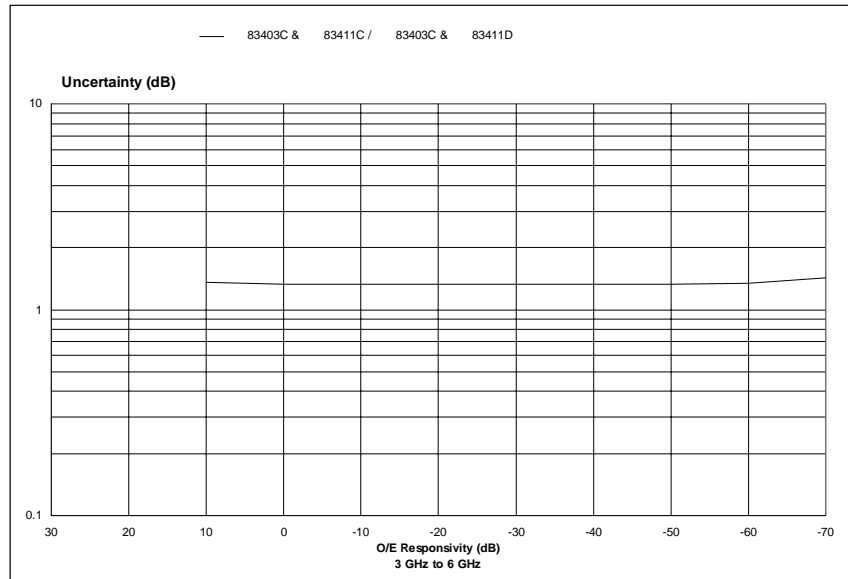


**Figure 4-8. Slope Responsivity Uncertainty vs. O/E Responsivity
300 kHz to 3 GHz (*characteristic*)**

System O/E Characteristics



**Figure 4-9. Slope Responsivity Uncertainty vs. O/E Responsivity
3 GHz to 6 GHz (*characteristic*)**



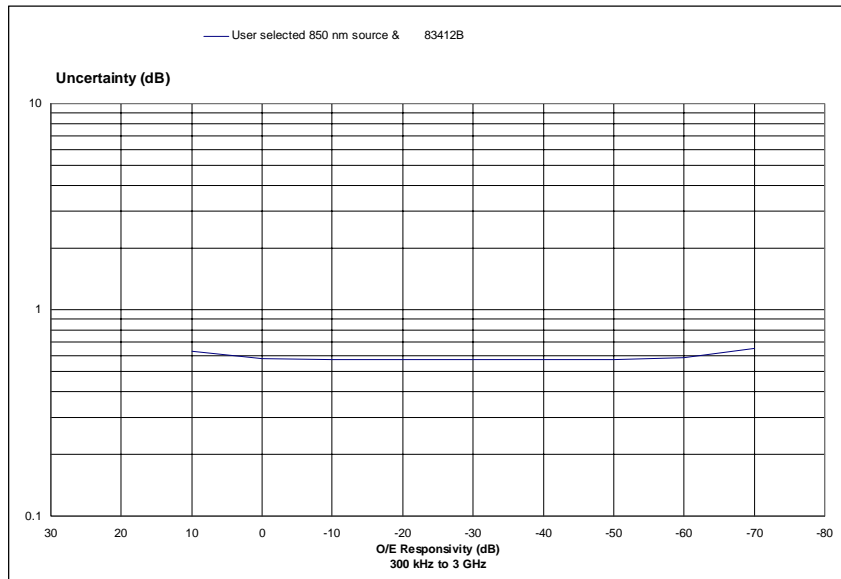
**Figure 4-10. Slope Responsivity Uncertainty vs. O/E Responsivity
3 GHz to 6 GHz (*characteristic*)**

The following plot is based on an Agilent 8702E Option 011 system for 850 nm measurements consisting of the following:

- Agilent 8702E Option 011 for 300 kHz to 3 GHz modulation bandwidth
- User-selected 850 nm source with the following characteristics:
 - Electrical input return loss = 14 dB_e
 - Optical output return loss = 34 dB_o
 - Responsivity = -26 dB_e
- Agilent 83412B 850 nm Lightwave Receiver
- Agilent 11887A Interconnect Cable Kit (HMS-10)
- Agilent 11889A RF Interface Kit

Assumptions or Conditions

- Receiver response calibration using disk data for the Agilent 83412B
- Device under test optical input return loss = 30 dB_o
- Device under test electrical output return loss = 14 dB_e
- RF input power to the lightwave source = +10 dB_m

System O/E Characteristics

**Figure 4-11. Slope Responsivity Uncertainty vs. O/E Responsivity
300 kHz to 3 GHz (*characteristic*)**

The two curves in the following plot show the uncertainty in a measurement of deviation from linear phase response after the average group delay has been removed for 3 GHz and 6 GHz measurements. Locate the device under test's responsivity in dB along the X axis. For modulation frequencies between 300 kHz and 3 GHz, read the uncertainty value off the Y axis that corresponds to the 3 GHz curve. For modulation frequencies between 3 GHz and 6 GHz read the uncertainty value corresponding to the 6 GHz curve.

Assumptions or Conditions

- Receiver response & match calibration using disk data for the Agilent 8341XX selected
- Device under test optical input return loss = 30 dBo
- Device under test electrical output return loss = 14 dBc
- RF input power to the lightwave source = +10 dBm

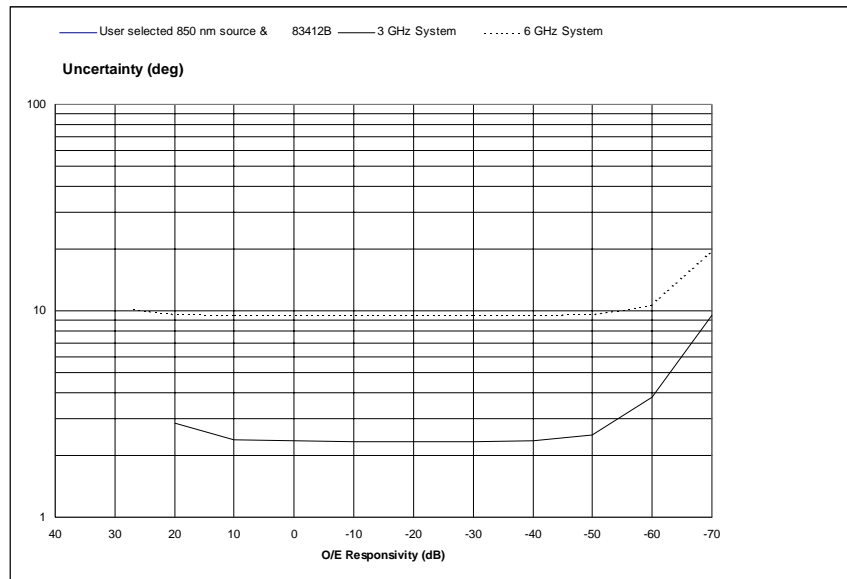


Figure 4-12. Deviation from Linear Phase vs. O/E Responsivity (*characteristic*)

3 GHz and 6 GHz 75 Ω System Configuration

The following plots are based on an Agilent 8702E Option 075 system consisting of the following:

- Agilent 8702E Option 075 for 300 kHz to 2 GHz modulation bandwidth
- Agilent 8340XX SMF Lightwave Source
- Agilent 8341XX Lightwave Receiver
- Agilent 11886A Interconnect Cable Kit (HMS-10)
- Agilent 11857B 75 Ω Type-N Test Port Cables
- Agilent 11852B Option 004 50 Ω to 75 Ω Minimum Loss Pad (2)
- Agilent Part Number 1250-1750, Type-N to 3.5 mm (m) adapters (2)
- Agilent 85036B 75 Ω Type-N Calibration Kit

Assumptions or Conditions

- Receiver response & match calibration using disk data for the Agilent 83411C
- Device under test optical input return loss = 30 dBo
- Device under test electrical output return loss = 14 dBe
- RF input power to the lightwave source = +10 dBm

System O/E Characteristics

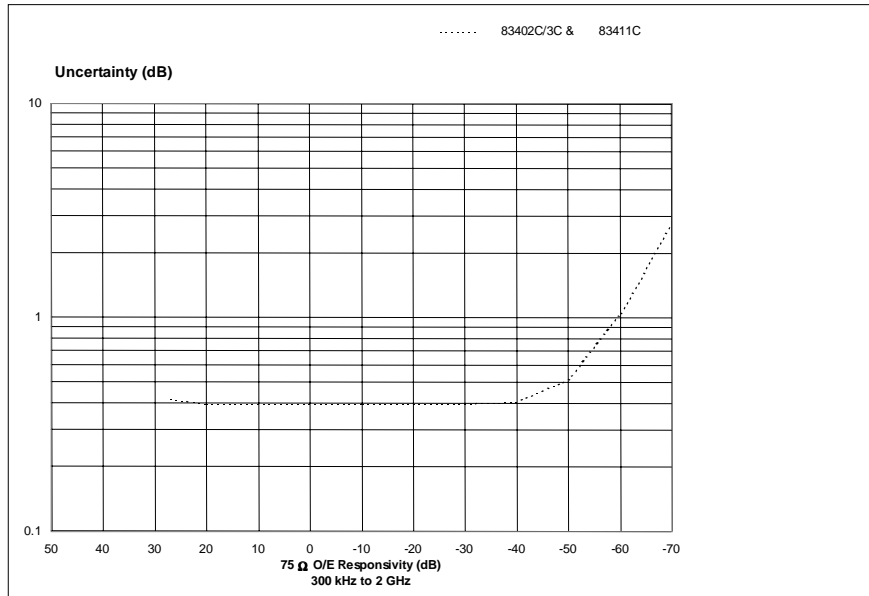


Figure 4-13. Slope Responsivity Uncertainty vs. O/E Responsivity 300 kHz to 2 GHz (*characteristic*)

The curve in the following plot shows the uncertainty in a measurement of deviation from linear phase response after the average group delay has been removed for measurements made at modulation frequencies at and below 2 GHz. Locate the device under test’s responsivity in dB along the X axis. Read the uncertainty value off the Y axis that corresponds to that point on the curve.

Assumptions or Conditions

- Receiver response & match calibration using disk data for the Agilent 83411C
- Device under test optical input return loss = 30 dBo
- Device under test electrical output return loss = 14 dB
- RF input power to the lightwave source = +10 dBm

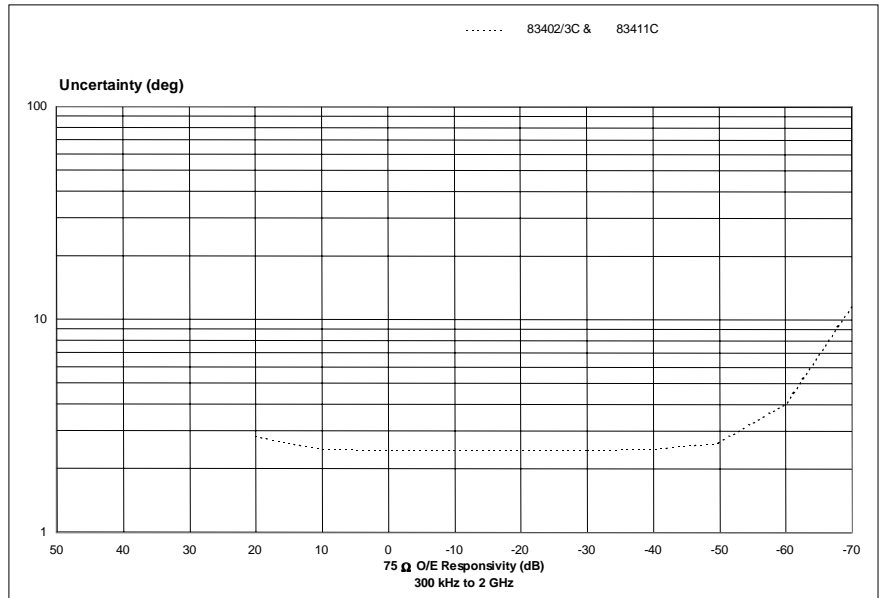


Figure 4-14. Deviation from Linear Phase vs. O/E Responsivity (*characteristic*)

System E/O Characteristics

Measurements of E/O devices with electrical inputs and optical outputs have a total value of uncertainty that includes various individual uncertainties. The total relative measurement uncertainty (dB) is shown plotted against the device under test responsivity (dB). These graphs refer to the relative flatness of modulation bandwidth measurements.

Included in the total relative uncertainty value (shown by the plots) are the following individual contributing uncertainties:

- Drift with temperature ($23 \pm 3^\circ\text{C}$)
- Dynamic accuracy
- Reflection sensitivity
- Wavelength accuracy
- Factory test (characterization) system
- Electrical mismatches or reflections between:
 - RF source/lightwave source RF input
 - RF receiver/lightwave receiver RF output
- Optical mismatches or reflections between:
 - lightwave source/lightwave receiver
 - device under test/ lightwave receiver

Absolute magnitude uncertainty includes additional error contributors, the greatest of which is optical connector loss uncertainty. An absolute uncertainty value for a specific data point can be calculated by adding ± 0.76 dB to the value found on the uncertainty graphs.

The responsivity of an E/O device can be read off the display in dB or linear for any given frequency. The *Agilent 8702E User's Guide* describes how to convert the dB value to its corresponding watts/amp responsivity value in the example for measuring an E/O converter where,

$$\text{Responsivity } R \text{ (dB)} = 20 \log_{10} [R (w/a) / 1 (w/a)]$$

3 GHz and 6 GHz 50 Ω System Configuration

The following plots are based on an Agilent 8702E system consisting of the following:

- Agilent 8702E (standard) for 300 kHz to 3 GHz modulation bandwidth, *or* Agilent 8702E Option 006 (6 GHz Frequency Extension) for 3 GHz to 6 GHz modulation bandwidth
- Agilent 8340XX SMF Lightwave Source
- Agilent 8341XX Lightwave Receiver
- Agilent 11886A Interconnect Cable Kit (HMS-10)
- Agilent 11857D 50 Ω 7 mm Test Port Return Cables
- Agilent 85033D 3.5 mm Calibration Kit

Assumptions or Conditions

- Source response & match calibration using disk data for the Agilent 8340XX selected
- Device under test electrical input return loss = 14 dB_e
- Device under test optical output return loss = 30 dB_o
- RF input power to the device under test = +10 dBm

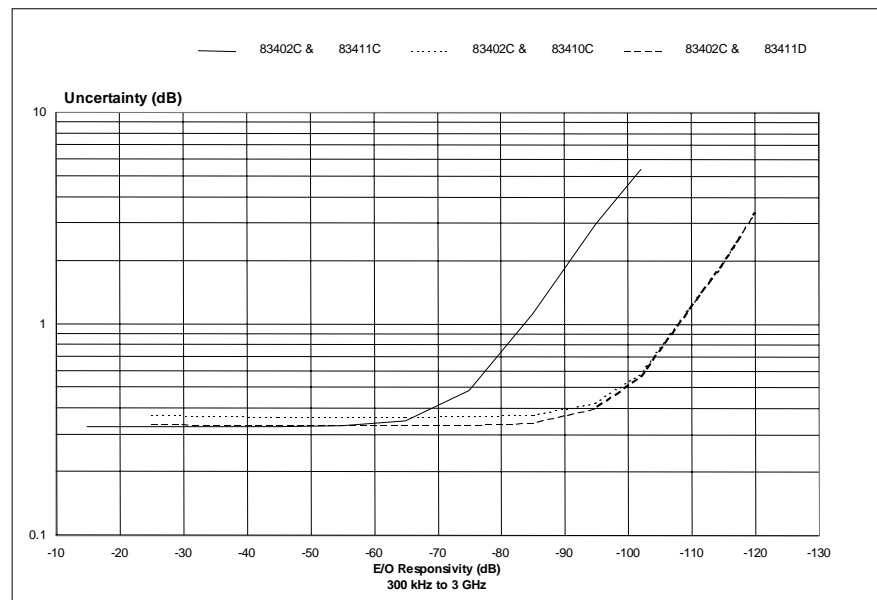
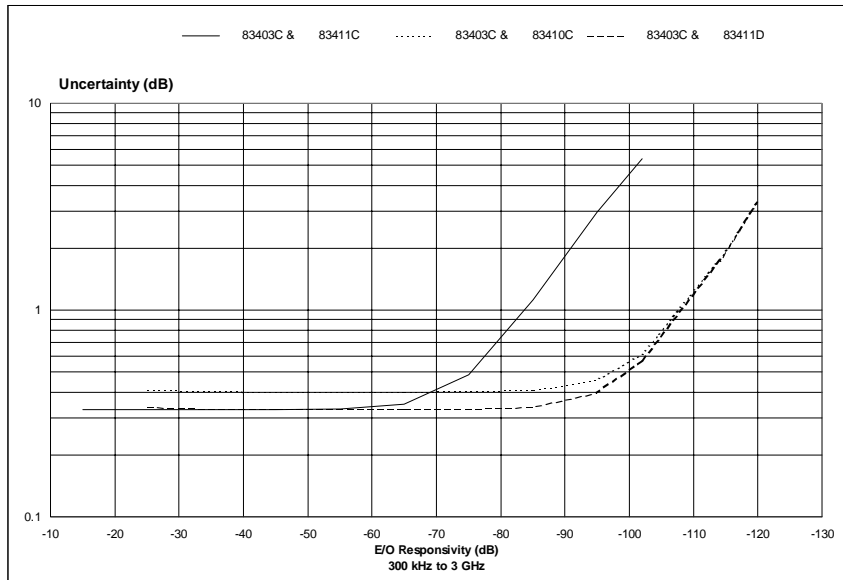
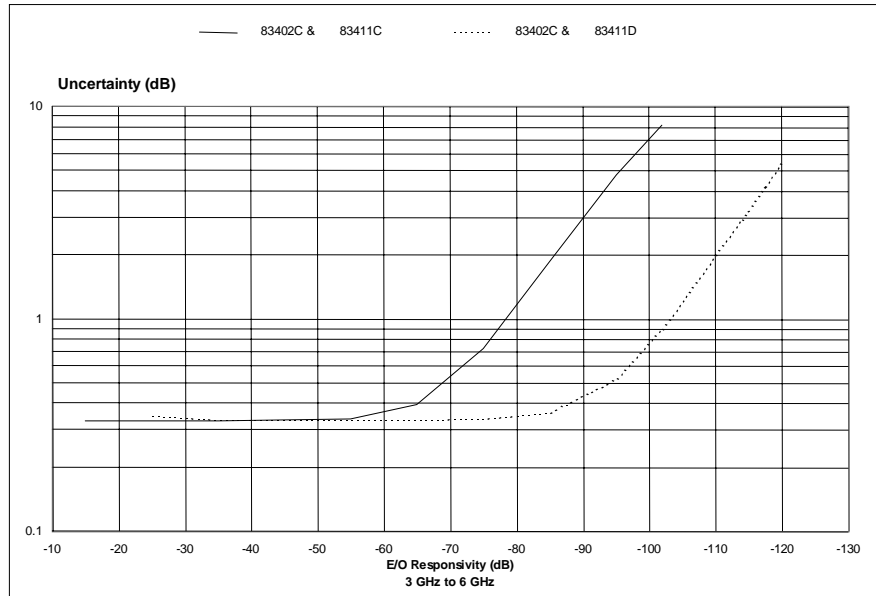


Figure 4-15. Slope Responsivity Uncertainty vs. E/O Responsivity 300 kHz to 3 GHz (*characteristic*)

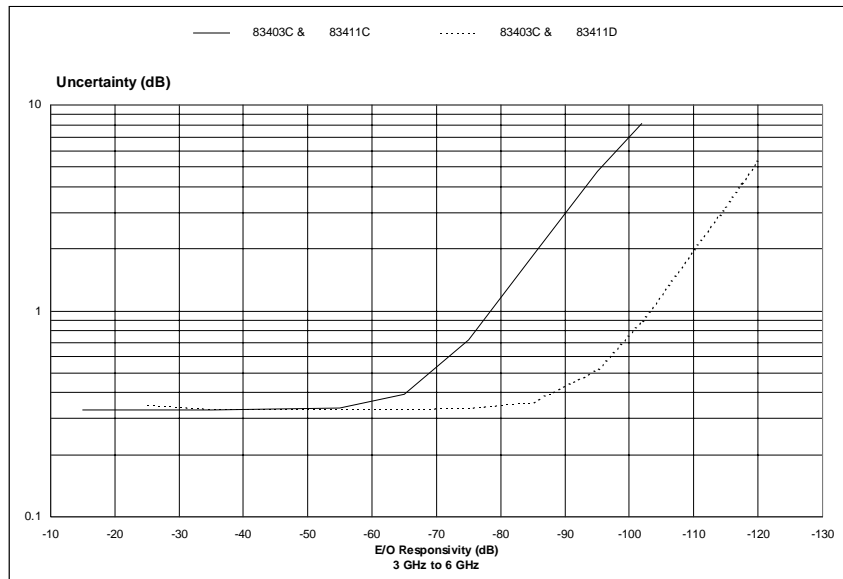
System E/O Characteristics



**Figure 4-16. Slope Responsivity Uncertainty vs. E/O Responsivity
300 kHz to 3 GHz (*characteristic*)**



**Figure 4-17. Slope Responsivity Uncertainty vs. E/O Responsivity
3 GHz to 6 GHz (*characteristic*)**

System E/O Characteristics

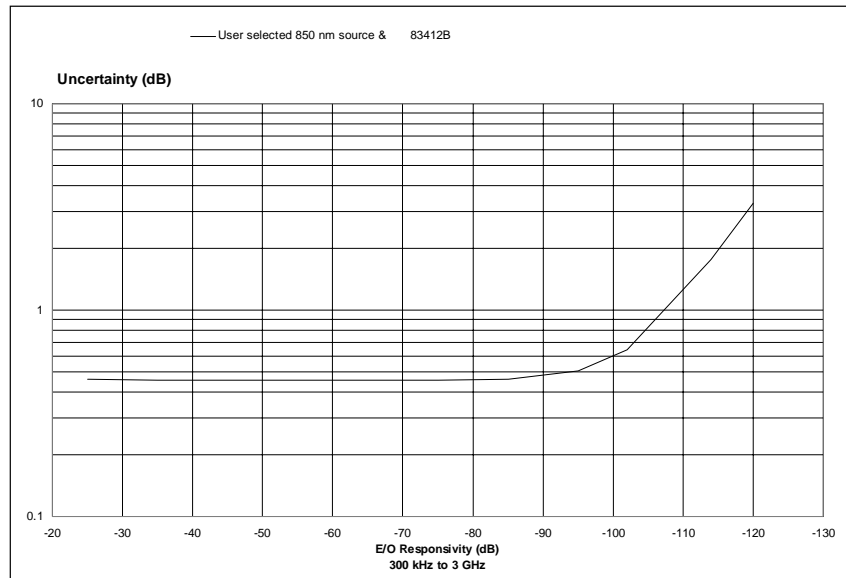
**Figure 4-18. Slope Responsivity Uncertainty vs. E/O Responsivity
3 GHz to 6 GHz (*characteristic*)**

The following plot is based on an Agilent 8702E system for 850 nm measurements consisting of the following:

- Agilent 8702E (standard) for 300 kHz to 3 GHz modulation bandwidth
- Agilent 83412B 850 nm Lightwave Receiver
- Agilent 11887A Interconnect Cable Kit (HMS-10)
- Agilent 11857D 50 Ω 7 mm Test Port Return Cables
- Agilent 85033D Calibration Kit

Assumptions or Conditions

- Source response & match calibration using the thru-receiver technique and disk data for the Agilent 83412B
- Device under test electrical input return loss = 14 dB_e
- Device under test optical output return loss = 34 dB_o
- Device under test responsivity = -26 dB_e
- RF input power to the device under test = +10 dBm



**Figure 4-19. Slope Responsivity Uncertainty vs. E/O Responsivity
300 kHz to 3 GHz (*characteristic*)**

The two curves in the following plot show the uncertainty in a measurement of deviation from linear phase response after the average group delay has been removed for 3 GHz and 6 GHz measurements. Locate the device under test's responsivity in dB along the X axis. For modulation frequencies between 300 kHz and 3 GHz, read the uncertainty value off the Y axis that corresponds to the 3 GHz curve. For modulation frequencies between 3 GHz and 6 GHz read the uncertainty value corresponding to the 6 GHz curve.

Assumptions or Conditions

- Source response & match calibration using disk data for the Agilent 8340XX selected
- Device under test electrical input return loss = 14 dB
- Device under test optical output return loss = 34 dB
- Device under test responsivity = -26 dB
- RF input power to the device under test = +10 dBm

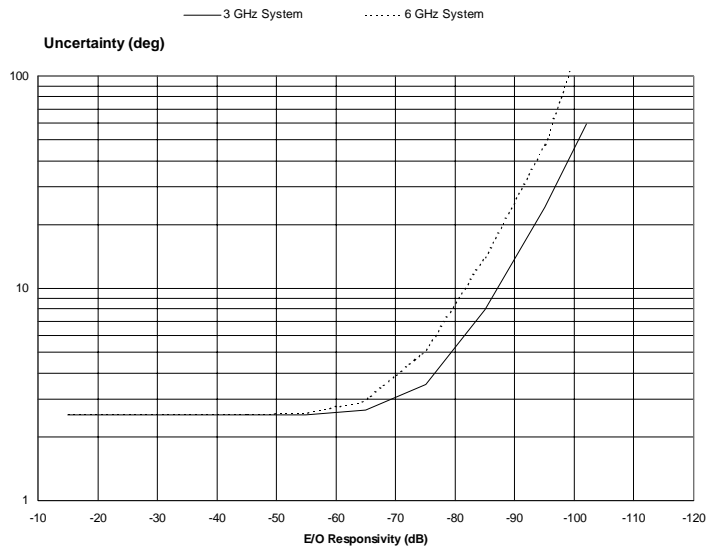
System E/O Characteristics

Figure 4-20. Deviation from Linear Phase vs. E/O Responsivity (*characteristic*)

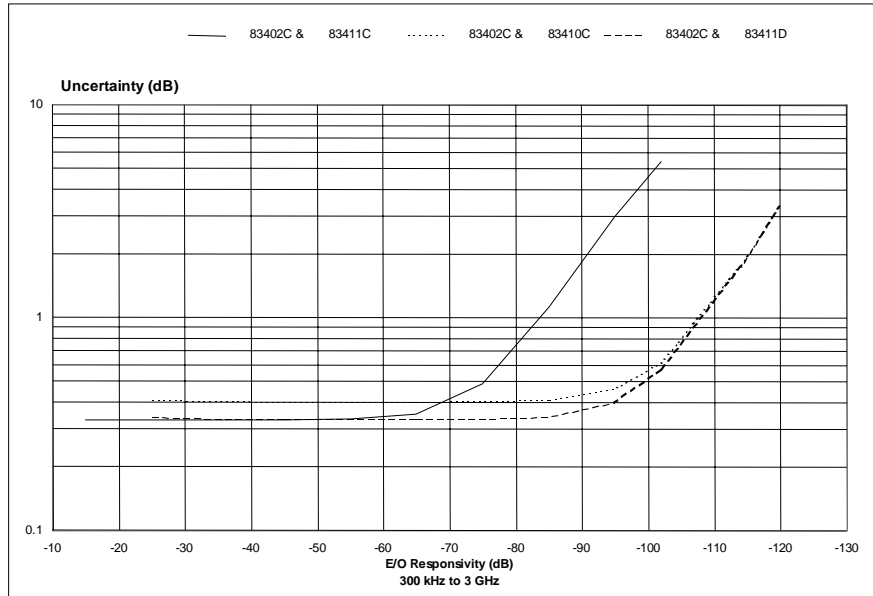
3 GHz and 6 GHz 50 Ω System Configuration for Agilent 8702E Option 011 and Agilent 11889A RF Interface Kit

The following plots are based on an Agilent 8702E Option 011 system consisting of the following:

- Agilent 8702E Option 011 for 300 kHz to 3 GHz modulation bandwidth, *or* Agilent 8702E Option 001, 006 (6 GHz Frequency Extension) for 3 GHz to 6 GHz modulation bandwidth
- Agilent 8340XX SMF Lightwave Source
- Agilent 8341XX Lightwave Receiver
- Agilent 11886A Interconnect Cable Kit (HMS-10)
- Agilent 11889A RF Interface Kit

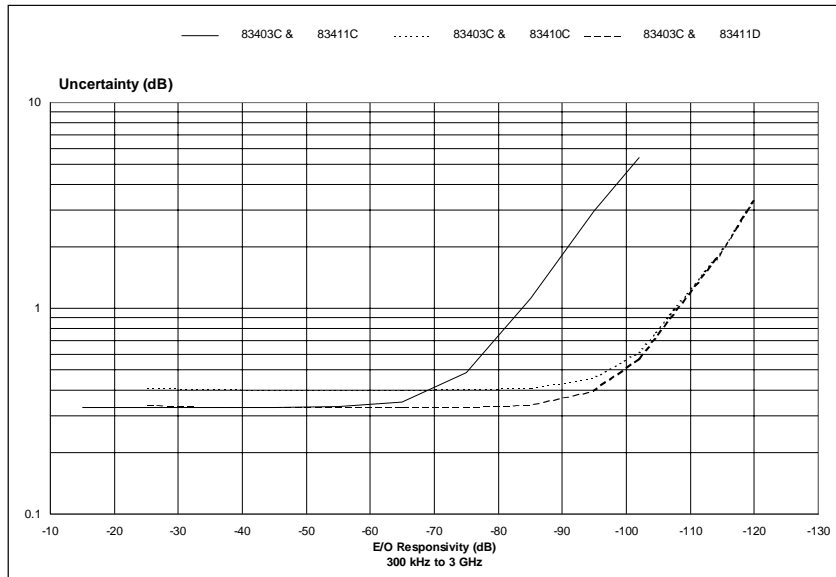
Assumptions or Conditions

- Source response calibration using disk data for the Agilent 8340XX selected
- Device under test electrical input return loss = 14 dB_e
- Device under test optical output return loss = 30 dB_o
- RF input power to the device under test = +14 dBm

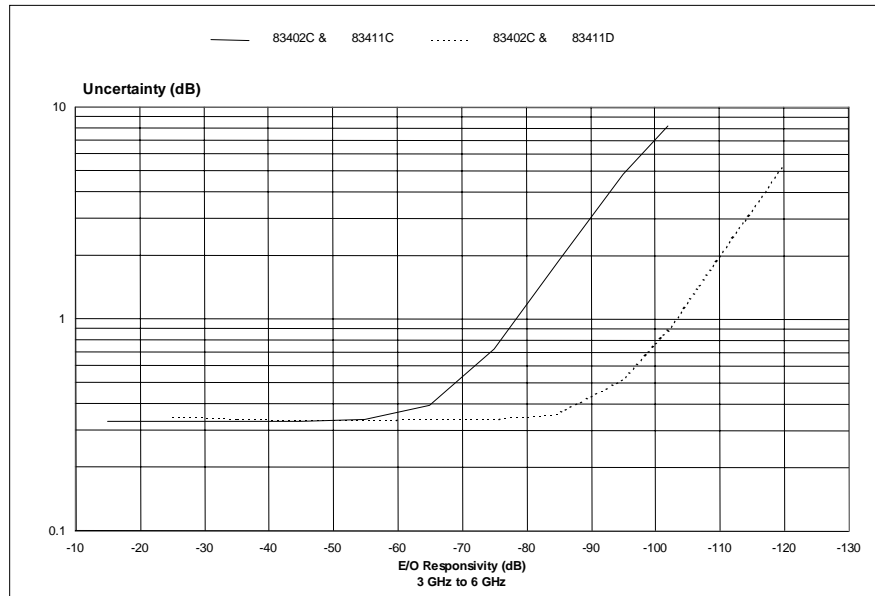


**Figure 4-21. Slope Responsivity Uncertainty vs. E/O Responsivity
300 kHz to 3 GHz (*characteristic*)**

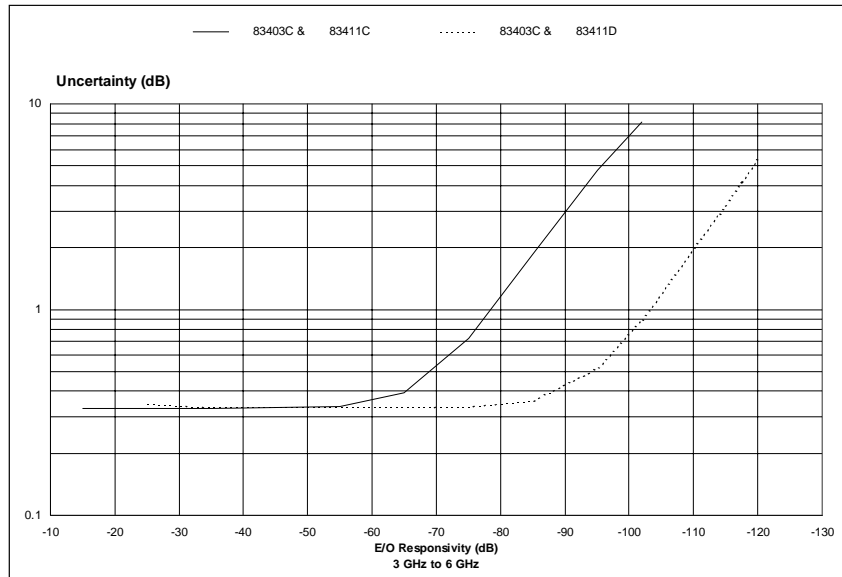
System E/O Characteristics



**Figure 4-22. Slope Responsivity Uncertainty vs. E/O Responsivity
300 kHz to 3 GHz (*characteristic*)**



**Figure 4-23. Slope Responsivity Uncertainty vs. E/O Responsivity
3 GHz to 6 GHz (*characteristic*)**

System E/O Characteristics

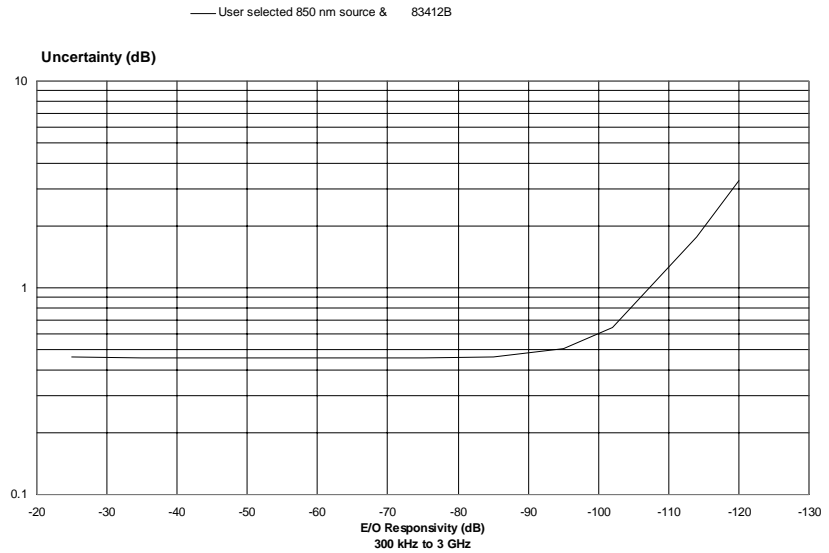
**Figure 4-24. Slope Responsivity Uncertainty vs. E/O Responsivity
3 GHz to 6 GHz (*characteristic*)**

The following plot is based on an Agilent 8702E Option 011 system for 850 nm measurements consisting of the following:

- Agilent 8702E Option 011 for 300 kHz to 3 GHz modulation bandwidth
- Agilent 83412B 850 nm Lightwave Receiver
- Agilent 11887A Interconnect Cable Kit (HMS-10)
- Agilent 11889A RF Interface Kit

Assumptions or Conditions

- Source response calibration using the thru-receiver technique and disk data for the Agilent 83412B
- Device under test electrical input return loss = 14 dB_e
- Device under test optical output return loss = 34 dB_o
- Device under test responsivity = -26 dB_e
- RF input power to the device under test = +10 dBm



**Figure 4-25. Slope Responsivity Uncertainty vs. E/O Responsivity
 300 kHz to 3 GHz (*characteristic*)**

The two curves in the following plot show the uncertainty in a measurement of deviation from linear phase response after the average group delay has been removed for 3 GHz and 6 GHz measurements. Locate the device under test’s responsivity in dB along the X axis. For modulation frequencies between 300 kHz and 3 GHz, read the uncertainty value off the Y axis that corresponds to the 3 GHz curve. For modulation frequencies between 3 GHz and 6 GHz read the uncertainty value corresponding to the 6 GHz curve.

Assumptions or Conditions

- Source response calibration using disk data for the Agilent 8340XX selected
- Device under test electrical input return loss = 14 dB_e
- Device under test optical output return loss = 30 dB_o
- RF input power to the device under test = +14 dBm

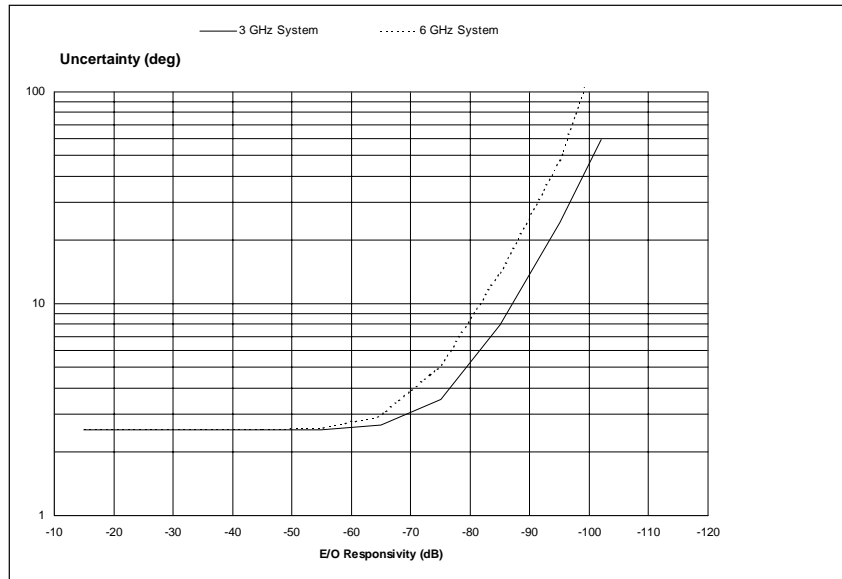
System E/O Characteristics

Figure 4-26. Deviation from Linear Phase vs. E/O Responsivity (*characteristic*)

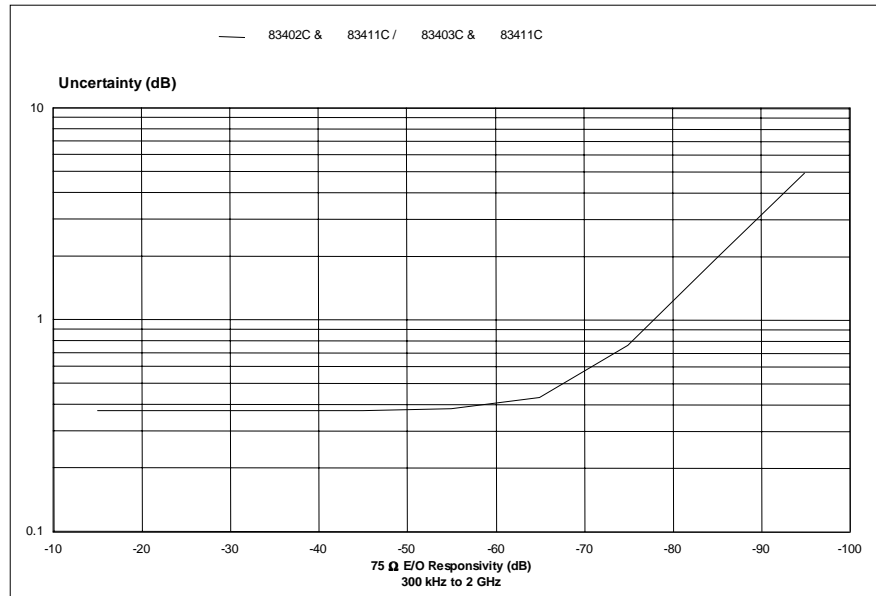
3 GHz and 6 GHz 75 Ω System Configuration

The following plots are based on an Agilent 8702E Option 075 system consisting of the following:

- Agilent 8702E Option 075 for 300 kHz to 2 GHz modulation bandwidth
- Agilent 8340XX SMF Lightwave Source
- Agilent 8341XX Lightwave Receiver
- Agilent 11886A Interconnect Cable Kit (HMS-10)
- Agilent 11857B 75 Ω Type-N Test Port Cables
- Agilent 11852B Option 004 50 Ω to 75 Ω Minimum Loss Pad (2)
- Agilent Part Number 1250-1750, Type-N to 3.5 mm (m) adapters (2)
- Agilent 85036B 75 Ω Type-N Calibration Kit

Assumptions or Conditions

- Source response & match calibration using disk data for the Agilent 83402C or Agilent 83403C
- Device under test electrical input return loss = 14 dB
- Device under test optical output return loss = 30 dB
- RF input power to the device under test = +10 dBm



**Figure 4-27. Slope Responsivity Uncertainty vs. E/O Responsivity
300 kHz to 2 GHz (*characteristic*)**

The curve in the following plot shows the uncertainty in a measurement of deviation from linear phase response after the average group delay has been removed for measurements made at modulation frequencies at and below 2 GHz. Locate the device under test's responsivity in dB along the X axis. Read the uncertainty value off the Y axis that corresponds to that point on the curve.

Assumptions or Conditions

- Source response & match calibration using disk data for the Agilent 83402C or Agilent 83403C
- Device under test electrical input return loss = 14 dB_e
- Device under test optical output return loss = 30 dB_o
- RF input power to the device under test = +10 dBm

System E/O Characteristics

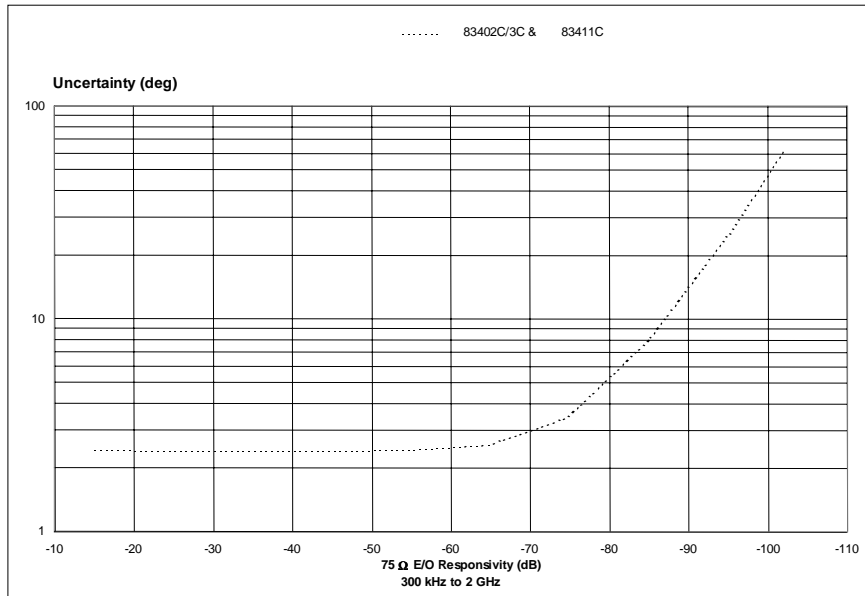


Figure 4-28. Deviation from Linear Phase vs. O/E Responsivity (*characteristic*)

System O/O Characteristics

Measurements of O/O devices with optical inputs and optical outputs have a total value of uncertainty that includes various individual uncertainties. The total relative measurement uncertainty (dB) is shown plotted against the device under test insertion loss (dB). These graphs refer to the relative flatness of modulation bandwidth measurements.

Included in the total relative uncertainty value (shown by the plots) are the following individual contributing uncertainties:

- Drift with temperature ($23 \pm 3^\circ\text{C}$)
- Dynamic accuracy
- Reflection sensitivity
- Wavelength accuracy
- Factory test (characterization) system
- Optical mismatches or reflections between:
 - lightwave source/lightwave receiver
 - lightwave source/device under test
 - device under test/ lightwave receiver

3 GHz and 6 GHz 50 Ω System Configuration

The following plots are based on an Agilent 8702E system consisting of the following:

- Agilent 8702E (standard) for 300 kHz to 3 GHz modulation bandwidth, *or* Agilent 8702E Option 006 (6 GHz Frequency Extension) for 3 GHz to 6 GHz modulation bandwidth
- Agilent 8340XX SMF Lightwave Source
- Agilent 8341XX Lightwave Receiver
- Agilent 11886A Interconnect Cable Kit (HMS-10)
- Agilent 11857D 50 Ω 7 mm Test Port Return Cables
- Agilent Part Number 85052-60004, 7 mm to 3.5 mm (m) adapters (2)

System O/O Characteristics

Assumptions or Conditions

- O/O thru calibration on Agilent 8702E
- Device under test optical input return loss = 30 dB_o
- Device under test optical output return loss = 30 dB_o
- RF input power to the lightwave source = +10 dBm

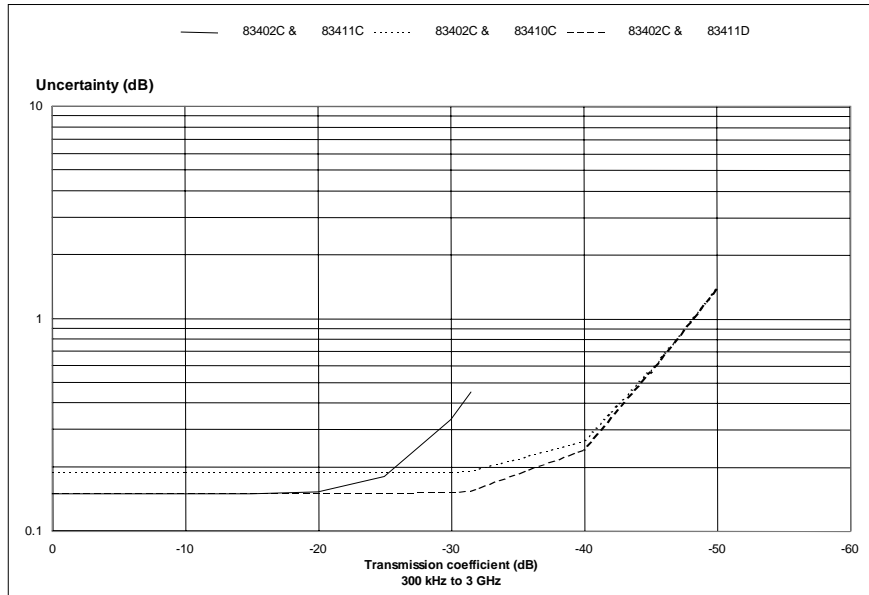


Figure 4-29. Relative Transmission Coefficient Uncertainty vs. O/O Transmission Coefficient 300 kHz to 3 GHz (*characteristic*)

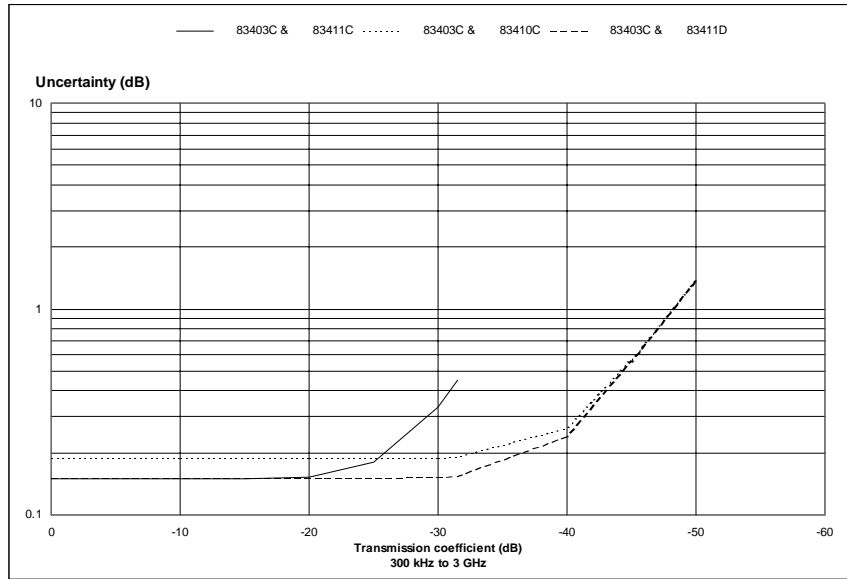
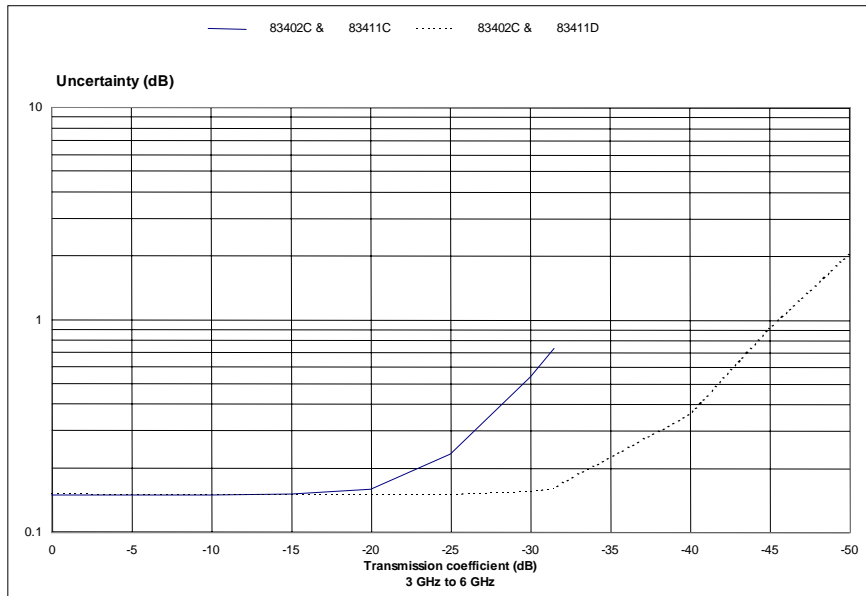


Figure 4-30. Relative Transmission Coefficient Uncertainty vs. O/O Transmission Coefficient 300 kHz to 3 GHz (*characteristic*)

System O/O Characteristics



**Figure 4-31. Relative Transmission Coefficient vs. O/O Transmission Coefficient
3 GHz to 6 GHz (*characteristic*)**

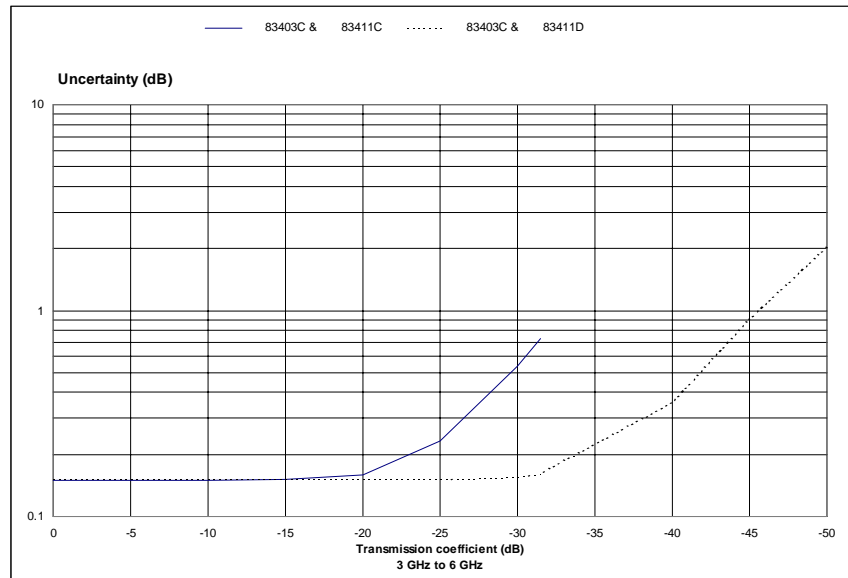


Figure 4-32. Relative Transmission Coefficient Uncertainty vs. O/O Transmission Coefficient 3 GHz to 6 GHz (*characteristic*)

The two curves in the following plot show the uncertainty in a measurement of deviation from linear phase response after the average group delay has been removed for 3 GHz and 6 GHz measurements. Locate the device under test's transmission coefficient in dB along the X axis. For modulation frequencies between 300 kHz and 3 GHz, read the uncertainty value off the Y axis that corresponds to the 3 GHz curve. For modulation frequencies between 3 GHz and 6 GHz, read the uncertainty value corresponding to the 6 GHz curve.

Assumptions or Conditions

- O/O thru calibration on Agilent 8702E
- Device under test optical input return loss = 30 dBo
- Device under test optical output return loss = 30 dBo
- RF input power to the lightwave source = +10 dBm

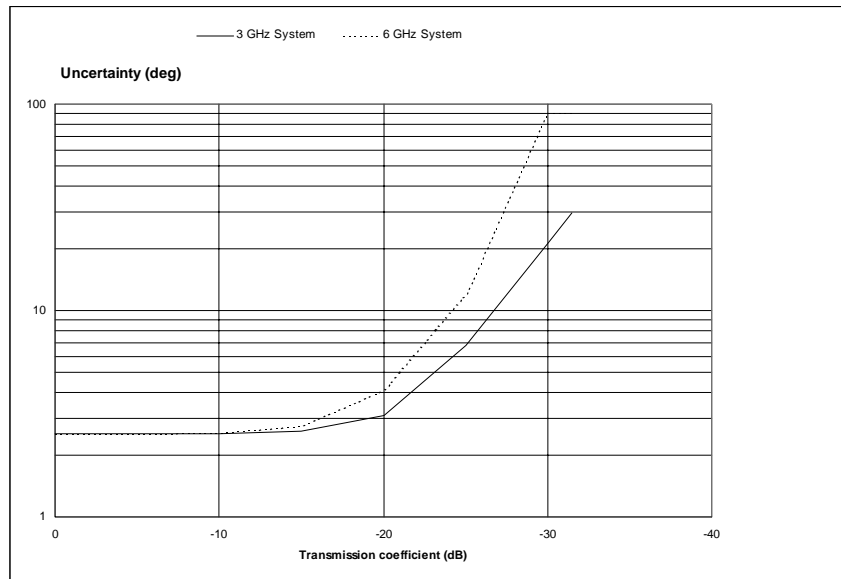
System O/O Characteristics

Figure 4-33. Deviation from Linear Phase vs. O/O Transmission Coefficient (*characteristic*)

3 GHz and 6 GHz 50 Ω System Configuration for Agilent 8702E Option 011 and Agilent 11889A RF Interface Kit

The following plots are based on an Agilent 8702E Option 011 system consisting of the following:

- Agilent 8702E Option 011 for 300 kHz to 3 GHz modulation bandwidth, *or* Agilent 8702E Option 001, 006 (6 GHz Frequency Extension) for 3 GHz to 6 GHz modulation bandwidth
- Agilent 8340XX SMF Lightwave Source
- Agilent 8341XX Lightwave Receiver
- Agilent 11886A Interconnect Cable Kit (HMS-10)
- Agilent 11889A RF Interface Kit

Assumptions or Conditions

- O/O thru calibration on Agilent 8702E Option 011
- Device under test optical input return loss = 30 dB_o
- Device under test optical output return loss = 30 dB_o
- RF input power to the lightwave source = +14 dBm

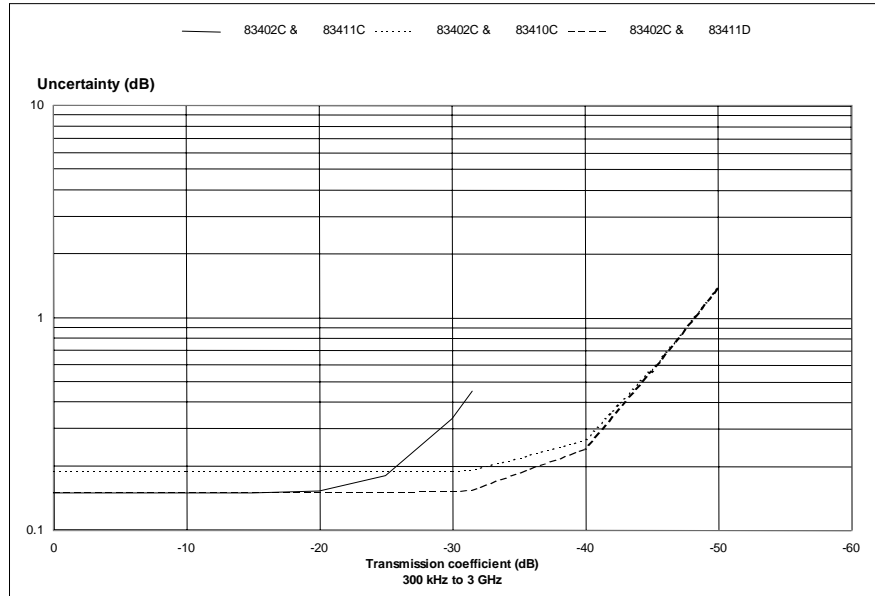


Figure 4-34. Relative Transmission Coefficient Uncertainty vs. O/O Transmission Coefficient 300 kHz to 3 GHz (*characteristic*)

System O/O Characteristics

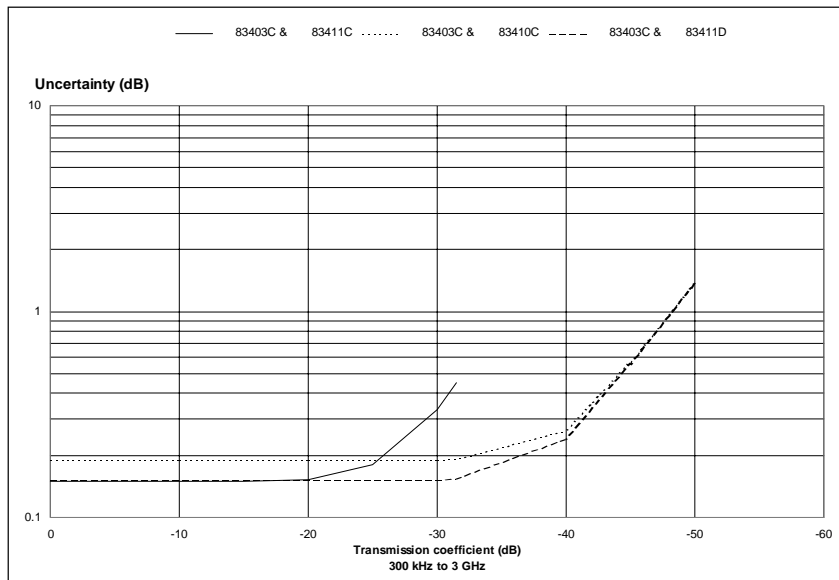


Figure 4-35. Relative Transmission Coefficient Uncertainty vs. O/O Transmission Coefficient 300 kHz to 3 GHz (*characteristic*)

System O/O Characteristics

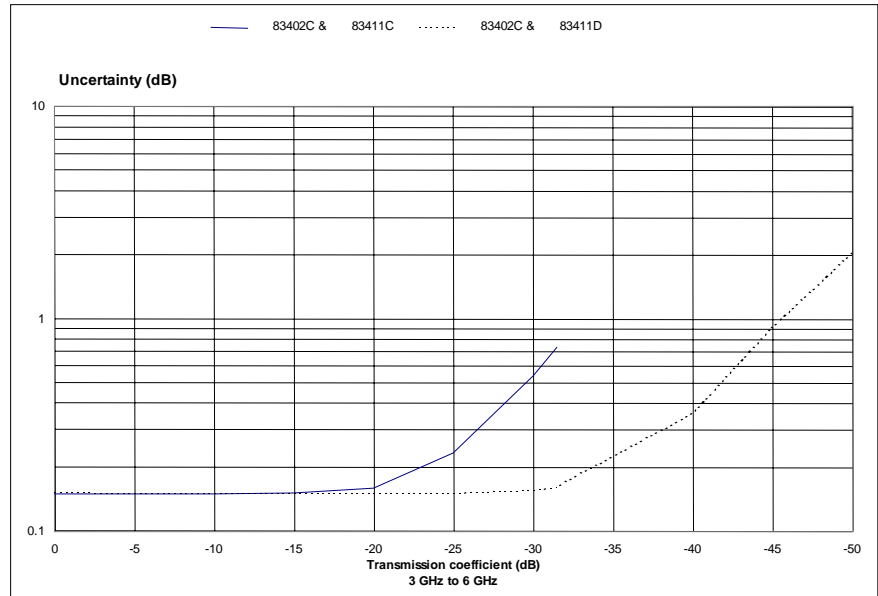


Figure 4-36. Relative Transmission Coefficient vs. O/O Transmission Coefficient 3 GHz to 6 GHz (*characteristic*)

System O/O Characteristics

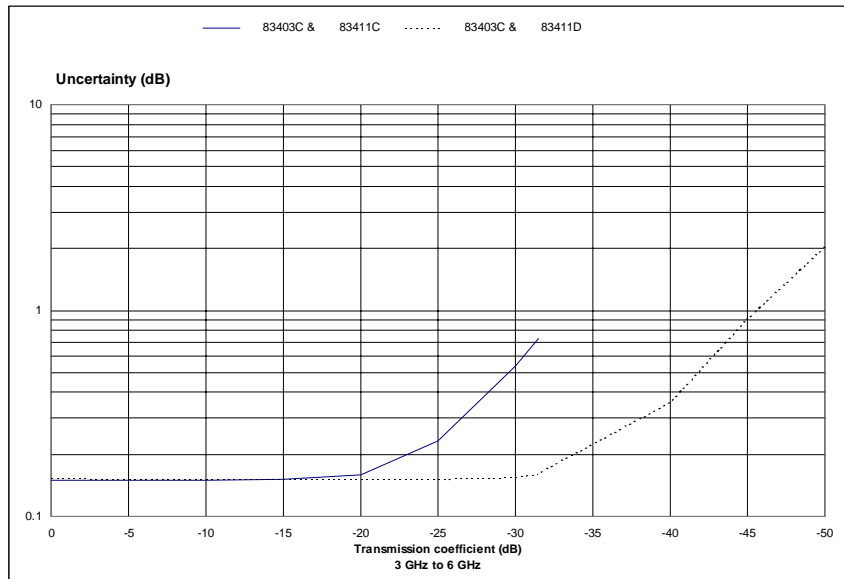


Figure 4-37. Relative Transmission Coefficient Uncertainty vs. O/O Transmission Coefficient 3 GHz to 6 GHz (*characteristic*)

The two curves in the following plot show the uncertainty in a measurement of deviation from linear phase response after the average group delay has been removed for 3 GHz and 6 GHz measurements. Locate the device under test's transmission coefficient in dB along the X axis. For modulation frequencies between 300 kHz and 3 GHz, read the uncertainty value off the Y axis that corresponds to the 3 GHz curve. For modulation frequencies between 3 GHz and 6 GHz, read the uncertainty value corresponding to the 6 GHz curve.

Assumptions or Conditions

- O/O thru calibration on Agilent 8702E Option 011
- Device under test optical input return loss = 30 dBo
- Device under test optical output return loss = 30 dBo
- RF input power to the lightwave source = +14 dBm

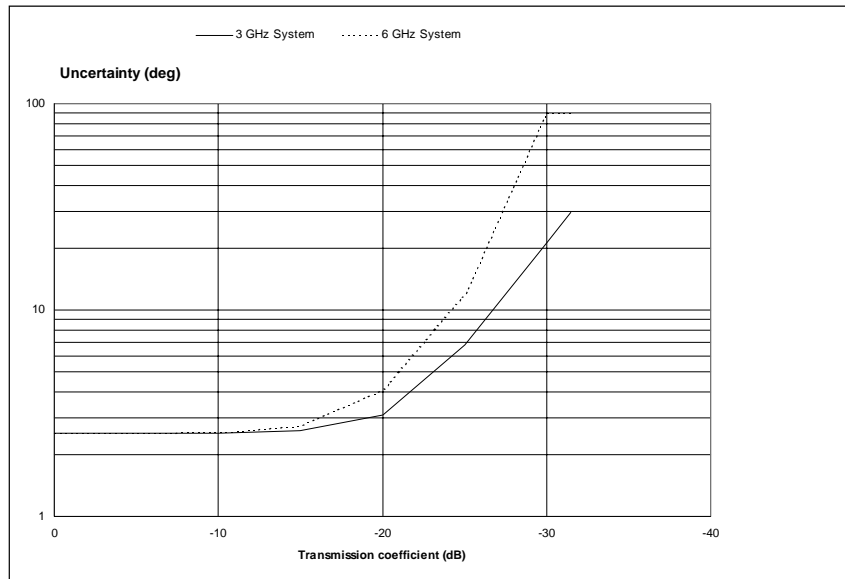


Figure 4-38. Deviation from Linear Phase vs. O/O Transmission Coefficient (*characteristic*)

Lightwave Receiver Measurement Repeatability

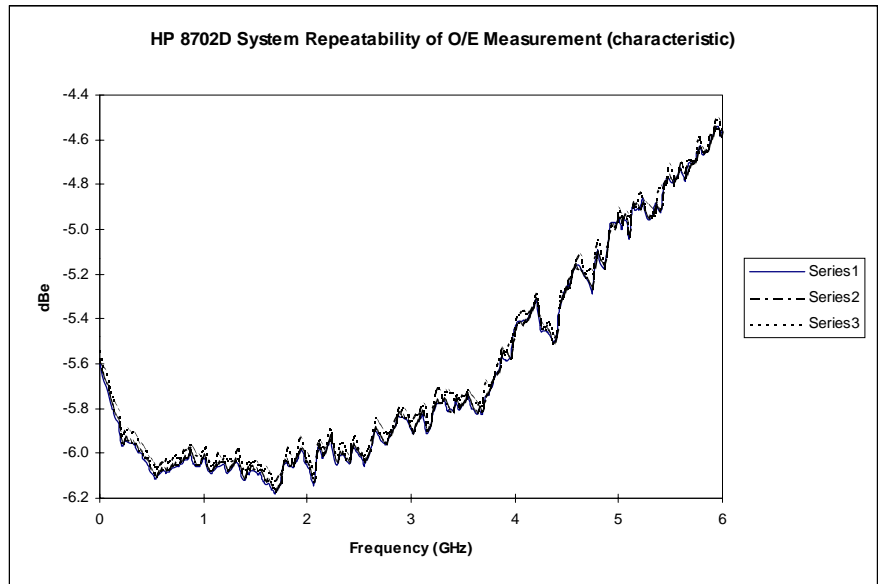
This plot shows the system's ability to accurately repeat measurements of the same O/E device.

A system consisting of an Agilent 8702E Option 006 (6 GHz Frequency Extension), Agilent 83403C 1550 nm Lightwave Source, and Agilent 83411C Lightwave Receiver was used to make measurements on a different Agilent 83411C Lightwave Receiver. The three traces in the following plot represent three measurements of the same Agilent 83411C (device under test) made on three completely different Agilent 8702 systems. A receiver response & match calibration was performed on each of the three systems using three different Agilent 83411Cs and their calibration data disks.

The following measurement conditions existed for all three measurements:

- 401 data points
- modulation frequency = 300 kHz to 6 GHz
- +10 dBm RF output power
- IF bandwidth = 30 Hz
- no averaging
- ambient temperature

The plot shows about 0.1 dBe (worst case) repeatability error.



**Figure 4-39. Agilent 8702E System Repeatability of O/E Measurement
(characteristic)**

GPIB Interface

GPIB interface operates according to IEEE 488-1978 and IEC 625 standards and IEEE 728-1982 recommended practices.

Transfer Formats

Binary (internal 48-bit floating point complex format)

ASCII

32/64 bit IEEE 754 Floating Point Format

Interface Function Codes

SH1, AH1, T6, TE0, L4, LEO, SR1, RL1, PP0, DC1, DT1, C1, C2, C3, C10, E2

Regulatory Information

- Laser Classification: This product contains an IEC LED Class 1.
- This product complies with 21 CFR 1040.10 and 1040.11.
- This product is designed for use in INSTALLATION CATEGORY II and POLLUTION DEGREE 2, per IEC 1010 and 664 respectively.

Notice for Germany: Noise Declaration

This is to declare that this instrument is in conformance with the German Regulation on Noise Declaration for Machines (Laermangabe nach der Maschinenlaermvvrordnung –3.GSGV Deutschland).

Acoustic Noise Emission	Geraeuschemission
LpA < 70 dB- Operator position Normal position per ISO 7779	LpA < 70 dB am Arbeitsplatz normaler Betrieb nach DIN 45635 t.19

Regulatory Information

DECLARATION OF CONFORMITY

According to ISO/IEC Guide 22 and CEN/CENELEC EN 45014

Manufacturer's Name: Agilent Technologies, Inc.
Manufacturer's Address: 1400 Fountaingrove Parkway
Santa Rosa, CA 95403-1799
USA

Declares that the product:

Product Name: Lightwave Component Analyzer
Model Number: 8702E
Product Options: This declaration covers all options of the above product.

Is in conformity with:

Safety: IEC 61010-1:1990 +A1:1992+A2:1995 / EN 61010-1:1994+A2:1995
CAN/CSA-C22.2 No. 1010.1-92

EMC: CISPR 11:1990/EN 55011:1991 Group 1, Class A
IEC 61000-4-2:1995+A1:1998 / EN 61000-4-2:1995, 4 kV CD, 8 kV AD
IEC 61000-4-3:1995 / EN 61000-4-3:1995, 3 V/m, 80-1000 MHz
IEC 61000-4-4:1995 / EN 61000-4-4:1995, 0.5 kV sig. lines, 1 kV pow. lines
IEC 61000-4-5:1995 / EN 61000-4-5:1995, 0.5 kV I-I, 1 kV I-e
IEC 61000-4-6:1996 / EN 61000-4-6:1996, 3V 80% AM, power line
IEC 61000-4-11:1994 / EN 61000-4-11:1994, 100 %, 20 ms

Supplementary Information:

The product herewith complies with the requirements of the Low Voltage Directive 73/23/EEC and the EMC Directive 89/336/EEC and carries the CE-marking accordingly.



Santa Rosa, CA, USA 20 Feb. 2001

Greg Pfeiffer/Quality Engineering Manager

For further information, please contact your local Agilent Technologies sales office, agent or distributor.

How the Agilent 8702E Works	5-2
The built-in synthesized source	5-3
The built-in test set	5-3
The receiver block	5-4
Required peripheral equipment	5-4
How the Agilent 8702E Processes Data	5-5
Using the Response Functions	5-10
Understanding S-parameters	5-11
Selecting the measurement	5-14
What is Measurement Calibration?	5-17
What is accuracy enhancement?	5-17
What causes measurement errors?	5-18
Characterizing microwave systematic errors	5-22
Correcting for measurement errors	5-34
How effective is accuracy enhancement?	5-35
Ensuring a valid calibration	5-37
The calibration standards	5-39
Modifying calibration kits	5-43
TRL*/LRM* calibration	5-56
Power meter calibration	5-59
Understanding and Using Time Domain	5-67
Time domain bandpass	5-69
Time domain low pass	5-73
Time domain concepts	5-81
Transforming CW time measurements into the frequency domain	5-90
Instrument Preset State and Memory Allocation	5-95
Types of memory and data storage	5-95
Conserving memory	5-100
Using saved calibration sets	5-100

Concepts

How the Agilent 8702E Works

Component analyzers measure the reflection and transmission characteristics of devices and networks. A component analyzer test system consists of the following:

- source
- signal-separation devices
- receiver
- display

The analyzer applies a signal that is transmitted through the test device, or reflected from its input, and then compares it with the incident signal generated by the swept RF source. The signals are then applied to a receiver for measurement, signal processing, and display.

The Agilent 8702E integrates a high resolution synthesized RF source, test set, and a dual channel three-input receiver to measure and display magnitude, phase, and group delay of transmitted and reflected power.

Agilent 8702E options are explained in [Chapter 2, “Reference”](#).

[Figure 5-1](#) is a simplified block diagram of the analyzer system. A detailed block diagram of the analyzer is provided in the *Agilent 8753D Network Analyzer Service Guide*, together with a theory of system operation.

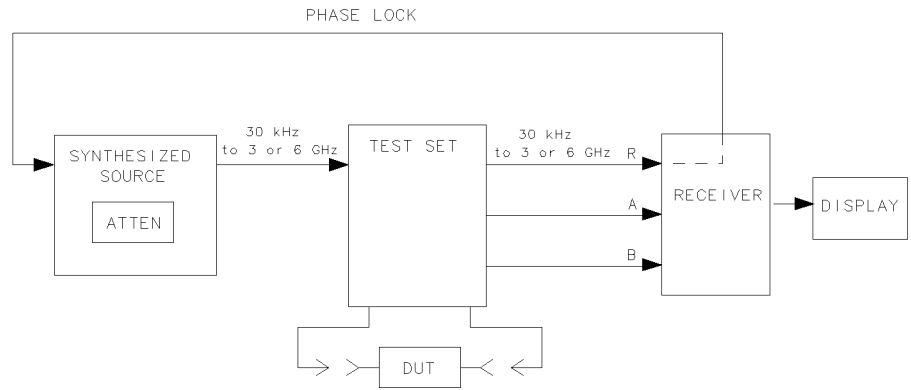


Figure 5-1. Simplified Block Diagram of the Analyzer System

The built-in synthesized source

The analyzer's built-in synthesized source produces a swept RF signal in the range of 300 kHz to 3.0 GHz. The Agilent 8702E Option 006 is able to generate signals up to 6 GHz. The RF output power is leveled by an internal ALC (automatic leveling control) circuit. To achieve frequency accuracy and phase measuring capability, the analyzer is phaselocked to a highly stable crystal oscillator. For this purpose, a portion of the transmitted signal is routed to the R channel input of the receiver, where it is sampled by the phase detection loop and fed back to the source.

The source step attenuator

The step attenuator, contained in the source, is used to adjust the power level to the test device, without changing the level of the incident power in the reference path.

The built-in test set

The Agilent 8702E features a built-in test set that provides connections to the test device, as well as to the signal-separation devices. The signal separation devices are needed to separate the incident signal from the transmitted and reflected signals. The incident signal is applied to the R channel input through

How the Agilent 8702E Works

a jumper cable on the front panel. Meanwhile, the transmitted and reflected signals are internally routed from the test port couplers to the inputs of the A and B sampler/mixers in the receiver. Port 1 is connected to the A input and port 2 is connected to the B input.

The test set contains the hardware required to make simultaneous transmission and reflection measurements in both the forward and reverse directions. An RF path switch in the built-in test set allows reverse measurements to be made without changing the connections to the test device.

The receiver block

The receiver block contains three sampler/mixers for the R, A, and B inputs. The signals are sampled, and mixed to produce a 4 kHz IF (intermediate frequency). A multiplexer sequentially directs each of the three signals to the ADC (analog-to-digital converter), where it is converted from an analog to a digital signal to be measured and processed for viewing on the display. Both amplitude and phase information are measured simultaneously, regardless of what is displayed on the analyzer.

The microprocessor

A microprocessor takes the raw data and performs all the required error correction, trace math, formatting, scaling, averaging, and marker operations, according to the instructions from the front panel or over GPIB. The formatted data is then displayed. The data processing sequence is described in [“How the Agilent 8702E Processes Data”](#) on page 5-5.

Required peripheral equipment

Measurements will require calibration standards for vector accuracy enhancement, and cables for interconnections. Model numbers and details of compatible power splitters, calibration kits, and cables are provided in [Chapter 2, “Reference”](#).

How the Agilent 8702E Processes Data

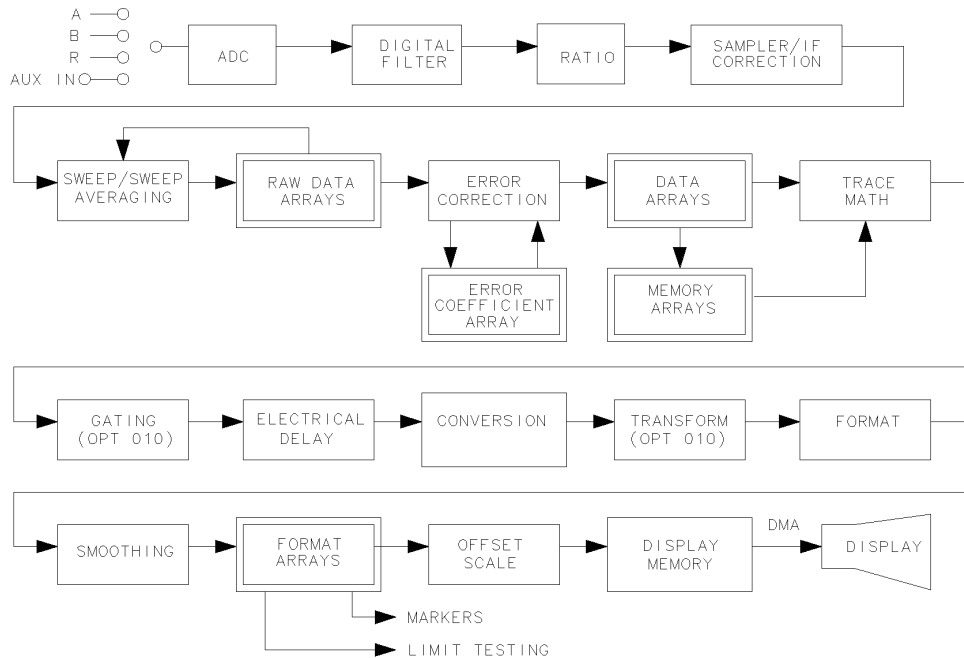
The analyzer's receiver converts the R, A, and B input signals into useful measurement information. This conversion occurs in two main steps:

- The swept high frequency input signals are translated to fixed low frequency IF signals, using analog sampling or mixing techniques. (Refer to the *Agilent 8753D Network Analyzer Service Guide* for more details on the theory of operation.)
- The IF signals are converted into digital data by an analog-to-digital converter (ADC). From this point on, all further signal processing is performed mathematically by the analyzer microprocessors.

The following section describes the sequence of math operations and the resulting data arrays as the information flows from the ADC to the display. It provide a good foundation for understanding most of the response functions, and the order in which they are performed.

[Figure 5-2](#) is a data processing flow diagram that represents the flow of numerical data from IF detection to display. The data passes through several math operations, denoted in the figure by single line boxes. Most of these operations can be selected and controlled with the front-panel response block function keys. (Refer to [“Using the Response Functions” on page 5-10](#) for more information.) The data is also stored in arrays along the way, denoted by double line boxes. These arrays are places in the flow path where data is accessible, usually via GPIB.

Concepts
How the Agilent 8702E Processes Data



pg638d

Figure 5-2. Data Processing Flow Diagram

While only a single flow path is shown, two identical paths are available, corresponding to channel 1 and channel 2. When the channels are uncoupled, each channel is processed and controlled independently.

Data point definition

A “data point”, or “point”, is a single piece of data representing a measurement at a single stimulus value. Most data processing operations are performed point-by-point; some involving more than one point.

Sweep definition

A “sweep” is a series of consecutive data point measurements, taken over a sequence of stimulus values. A few data processing operations require that a full sweep of data be available. The number of points per sweep can be defined by the user. The units of the stimulus values (such as power, frequency, and time) can change, depending on the sweep mode, although this does not generally affect the data processing path.

Processing details

- ADC** The ADC (analog-to-digital converter) converts the R, A, and B inputs (already down-converted to a fixed low frequency IF) into digital words. (The AUX INPUT connector on the rear panel is a fourth input.) The ADC switches rapidly between these inputs, so they are converted nearly simultaneously.
- IF detection** This occurs in the digital filter, which performs the discrete Fourier transform (DFT) on the digital words. The samples are converted into complex number pairs (real plus imaginary, $R+jX$). The complex numbers represent both the magnitude and phase of the IF signal. If the AUX INPUT is selected, the imaginary part of the pair is set to zero. The DFT filter shape can be altered by changing the IF bandwidth, which is a highly effective technique for noise reduction.
- Ratio calculations** These are performed if the selected measurement is a ratio of two inputs (for example, A/R or B/R). This is a complex divide operation. If the selected measurement is absolute (A or B), no operation is performed. The R, A, and B values are also split into channel data at this point.
- Sampler/IF correction** The next digital processing technique used is sampler/IF correction. This process digitally corrects for frequency response errors (both magnitude and phase, primarily sampler rolloff) in the analog down-conversion path.
- Sweep-to-sweep averaging** This is another noise reduction technique. This calculation involves taking the complex exponential average of several consecutive sweeps. This technique cannot be used with single-input measurements.
- Raw data arrays** These store the results of all the preceding data processing operations. (Up to this point, all processing is performed real-time with the sweep by the IF processor. The remaining operations are not necessarily synchronized with the sweep, and are performed by the main processor.) When full 2-port error correction is on, the raw arrays contain all four S-parameter measurements required for accuracy enhancement. When the channels are uncoupled (coupled channels off), there may be as many as eight raw arrays. These arrays are directly accessible via GPIB. Notice that the numbers here are still complex pairs.

How the Agilent 8702E Processes Data

Vector error correction (accuracy enhancement)

Error correction is performed next, if a measurement calibration has been performed and correction is activated. Error correction removes repeatable systematic errors (stored in the error coefficient arrays) from the raw arrays. This can vary from simple vector normalization to full 12-term error correction.

The error coefficient arrays themselves are created during a measurement calibration using data from the raw arrays. These are subsequently used whenever correction is on, and are accessible via GPIB.

The results of error correction are stored in the data arrays as complex number pairs. These arrays are accessible via GPIB.

If the data-to-memory operation is performed, the data arrays are copied into the memory arrays.

Trace math operation

This selects either the data array, memory array, or both to continue flowing through the data processing path. In addition, the complex ratio of the two (data/memory) or the difference (data–memory) can also be selected. If memory is displayed, the data from the memory arrays goes through exactly the same data processing flow path as the data from the data arrays.

Gating

This is a digital filtering operation associated with time domain transformation. Its purpose is to mathematically remove unwanted responses isolated in time. In the time domain, this can be viewed as a time-selective bandpass or bandstop filter. (If both data and memory are displayed, gating is applied to the memory trace only if gating was on when data was stored into memory.)

The delay block

This involves adding or subtracting phase in proportion to frequency. This is equivalent to “line-stretching” or artificially moving the measurement reference plane.

Conversion transforms

This transforms the measured S-parameter data to the equivalent complex impedance (Z) or admittance (Y) values, or to inverse S-parameters (1/S).

Windowing

This is a digital filtering operation that prepares (enhances) the frequency domain data for transformation to time domain.

Time domain transform

This converts frequency domain information into the time domain when transform is on. The results resemble time domain reflectometry (TDR) or impulse-response measurements. The transform uses the chirp-Z inverse fast Fourier transform (FFT) algorithm to accomplish the conversion. The windowing

operation, if enabled, is performed on the frequency domain data just before the transform. (A special transform mode is available to “demodulate” CW sweep data, with time as the stimulus parameter, and display spectral information with frequency as the stimulus parameter.)

Formatting

This converts the complex number pairs into a scalar representation for display, according to the selected format. This includes group delay calculations. These formats are often easier to interpret than the complex number representation. (Polar and Smith chart formats are not affected by the scalar formatting.) Notice that after formatting, it is impossible to recover the complex data.

Smoothing

This is another noise reduction technique, that smooths noise on the trace. The primary application of smoothing is to set the aperture for group delay measurements.

When smoothing is on, each point in a sweep is replaced by the moving average value of several adjacent (formatted) points. The number of points included depends on the smoothing aperture, which can be selected by the user. The effect is similar to video filtering. If data and memory are displayed, smoothing is performed on the memory trace only if smoothing was on when data was stored into memory.

Format arrays

The results, so far, are stored in the format arrays. Notice that the marker values and marker functions are all derived from the format arrays. Limit testing is also performed on the formatted data. The format arrays are accessible via GPIB.

Offset and scale

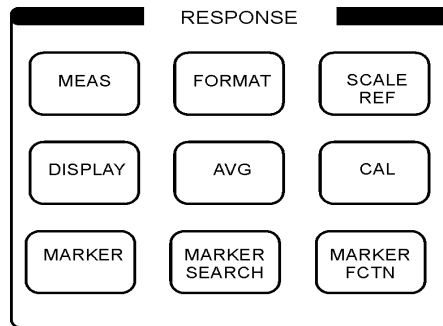
These operations prepare the formatted data for display. This is where the reference line position, reference line value, and scale calculations are performed, as appropriate to the format.

Display memory

The display memory stores the display image for presentation on the analyzer. The information stored includes graticules, annotation, and softkey labels. If user display graphics are written, these are also stored in display memory. When hardcopy records are made, the information sent to the plotter or printer is taken from display memory.

Finally, the display memory data is sent to the analyzer’s display. The display is updated frequently and asynchronously with the data processing operations.

Using the Response Functions



pg6118d

Figure 5-3. Response Function Block

The response function block keys are used to define and control the following functions of the *active channel*.

- measurement parameters
- display format
- display functions
- noise reduction alternatives
- calibration functions
- display markers

The current values for the major response functions of the active channel are displayed in specific locations along the top of the display. In addition, certain functions accessed through the keys in this block are annotated in the status notations area at the left side of the display. An illustration of the analyzer's display, showing the locations of these information labels, is provided in [Chapter 2, "Reference"](#).

Understanding S-parameters

S-parameters (scattering parameters) are a convention used to characterize the way a device modifies signal flow. A brief explanation of the S-parameters of a two-port device is provided here. For additional details, refer to *Agilent Technologies Application Notes A/N 95-1 and A/N 154*.

S-parameters are always a ratio of two complex (magnitude and phase) quantities. S-parameter notation identifies these quantities using the numbering convention:

$$S_{(\text{out}) (\text{in})}$$

where the first number (out) refers to the test-device port where the signal is emerging and the second number (in) is the test-device port where the signal is incident. For example, the S-parameter S_{21} identifies the measurement as the complex ratio of the signal emerging at the test device's port 2 to the signal incident at the test device's port 1.

[Figure 5-4](#) is a representation of the S-parameters of a two-port device, together with an equivalent flowgraph. In the illustration, “a” represents the signal entering the device and “b” represents the signal emerging. Note that “a” and “b” are not related to the A and B input ports on the analyzer.

Using the Response Functions

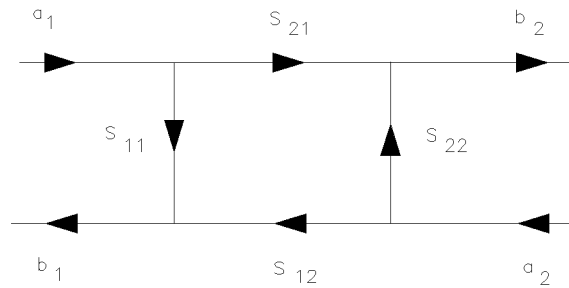
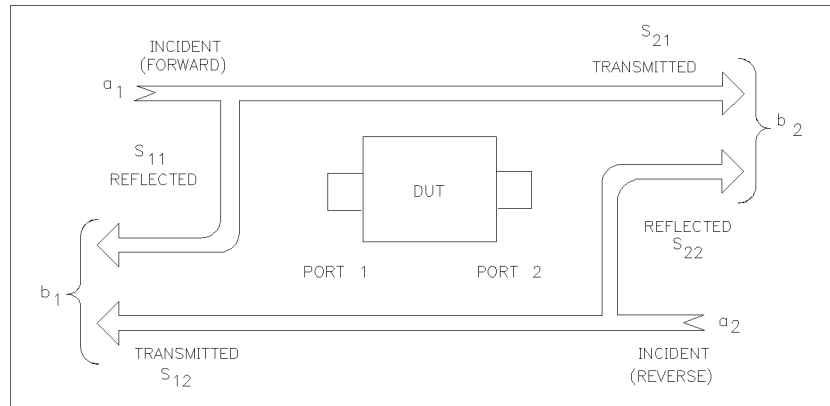


Figure 5-4. S-Parameters of a Two-Port Device

S-parameters are exactly equivalent to the more common description terms shown in [Table 5-1](#), requiring only that the measurements be taken with all test device ports properly terminated.

Table 5-1. S-Parameter Descriptions

S-Parameter	Definition	Test Set Description	Direction
S_{11}	$\frac{b_1}{a_1} \text{ } a_2 = 0$	Input reflection coefficient	FWD

Using the Response Functions**Table 5-1. S-Parameter Descriptions**

S-Parameter	Definition	Test Set Description	Direction
S_{21}	$\frac{b_2}{a_1} \quad a_2 = 0$	Forward gain	FWD
S_{12}	$\frac{b_1}{a_2} \quad a_1 = 0$	Reverse gain	REV
S_{22}	$\frac{b_2}{a_2} \quad a_1 = 0$	Output reflection coefficient	REV

Selecting the measurement

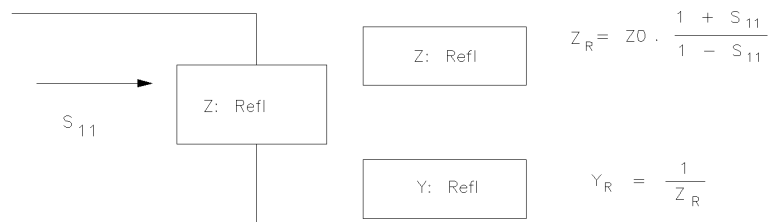
The MEAS key leads to a series of softkey menus used to select the parameters or inputs that define the type of measurement being performed.

S-parameter menu The S-parameter menu is used to define the input ports and test set direction for S-parameter measurements. The analyzer automatically switches the direction of the measurement according to the selections made in this menu. Therefore, all four S-parameters can be measured with a single connection. The S-parameter being measured is labeled at the top left corner of the display.

Input ports menu This menu is used to define the input ports for power ratio measurements, or a single input for magnitude only measurements of absolute power. Single inputs cannot be used for phase or group delay measurements, or any measurements with averaging activated.

Conversion menu This menu converts the measured reflection or transmission data to the equivalent complex impedance (*Z*) or admittance (*Y*) values. This is not the same as a two-port *Y* or *Z* parameter conversion, as only the measured parameter is used in the equations. Two simple one-port conversions are available, depending on the measurement configuration.

An S_{11} or S_{22} trace measured as reflection can be converted to equivalent parallel impedance or admittance using the model and equations shown in [Figure 5-5](#).



pg640d

Figure 5-5. Reflection Impedance and Admittance Conversions

In a transmission measurement, the data can be converted to its equivalent series impedance or admittance using the model and equations shown in [Figure 5-6](#).

Using the Response Functions

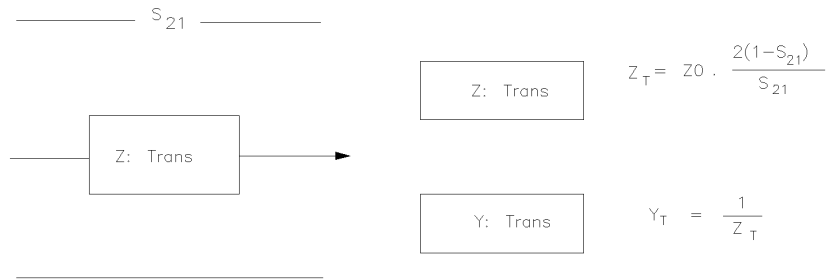


Figure 5-6. Transmission Impedance and Admittance Conversions

Avoid the use of Smith chart, SWR, and delay formats for display of Z and Y conversions, as these formats are not easily interpreted.

What is Measurement Calibration?

Measurement calibration is an accuracy enhancement procedure that effectively removes the system errors that cause uncertainty in measuring a test device. It measures known standard devices, and uses the results of these measurements to characterize the system.

This section discusses the following topics:

- definition of accuracy enhancement
- causes of measurement errors
- characterization of microwave systematic errors
- correcting for measurement errors
- effectiveness of accuracy enhancement
- ensuring a valid calibration
- calibration standards
- modifying calibration kits
- calibrating for non-insertable devices
- TRL*/LRM* calibration
- power meter calibration

What is accuracy enhancement?

A perfect measurement system would have infinite dynamic range, isolation, and directivity characteristics, no impedance mismatches in any part of the test setup, and flat frequency response. In any high frequency measurement there are measurement errors associated with the system that contribute uncertainty to the results. Parts of the measurement setup, such as interconnecting cables and signal-separation devices (as well as the analyzer itself), all introduce variations in magnitude and phase that can mask the actual perfor-

What is Measurement Calibration?

mance of the test device. Vector accuracy enhancement, also known as measurement calibration or error correction, provides the means to simulate a nearly perfect measurement system.

For example, crosstalk due to the channel isolation characteristics of the analyzer can contribute an error equal to the transmission signal of a high-loss test device. For reflection measurements, the primary limitation of dynamic range is the directivity of the test setup. The measurement system cannot distinguish the true value of the signal reflected by the test device from the signal arriving at the receiver input due to leakage in the system. For both transmission and reflection measurements, impedance mismatches within the test setup cause measurement uncertainties that appear as ripples superimposed on the measured data.

Measurement calibration simulates a perfect analyzer system. It measures the magnitude and phase responses of known standard devices, and compares the measurement with actual device data. It uses the results to characterize the system and effectively remove the system errors from the measurement data of a test device, using vector math capabilities internal to the analyzer.

When you use measurement calibration, the dynamic range and accuracy of the measurement are limited only by system noise and stability, connector repeatability, and the accuracy to which the characteristics of the calibration standards are known.

What causes measurement errors?

Analysis measurement errors can be separated into systematic, random, and drift errors.

Correctable systematic errors are the repeatable errors that the system can measure. These are errors due to mismatch and leakage in the test setup, isolation between the reference and test signal paths, and system frequency response.

The system cannot measure and correct for the non-repeatable random and drift errors. These errors affect both reflection and transmission measurements. Random errors are measurement variations due to noise and connector repeatability. Drift errors include frequency drift, temperature drift, and other physical changes in the test setup between calibration and measurement.

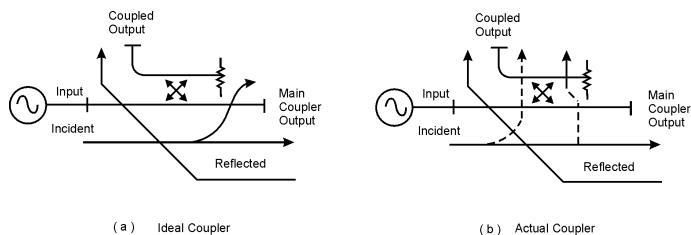
The resulting measurement is the vector sum of the test device response plus all error terms. The precise effect of each error term depends upon its magnitude and phase relationship to the actual test device response.

In most high frequency measurements the systematic errors are the most significant source of measurement uncertainty. Since each of these errors can be characterized, their effects can be effectively removed to obtain a corrected value for the test device response. For the purpose of vector accuracy enhancement these uncertainties are quantified as directivity, source match, load match, isolation (crosstalk), and frequency response (tracking). Each of these systematic errors is described in this section.

Random and drift errors cannot be precisely quantified, so they must be treated as producing a cumulative uncertainty in the measured data.

Directivity

Normally a device that can separate the reverse from the forward-traveling waves (a directional bridge or coupler) is used to detect the signal reflected from the test device. Ideally the coupler would completely separate the incident and reflected signals, and only the reflected signal would appear at the coupled output, as illustrated in [Figure 5-7a](#).



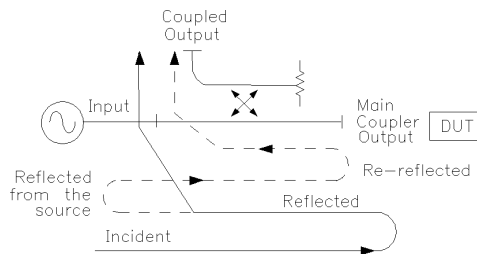
pg646d

Figure 5-7. Directivity

However, an actual coupler is not perfect, as illustrated in [Figure 5-7b](#). A small amount of the incident signal appears at the coupled output due to leakage, as well as reflection from the termination in the coupled arm. Also, reflections from the coupler output connector appear at the coupled output, adding uncertainty to the signal reflected from the device. The figure of merit, for how well a coupler separates forward and reverse waves, is directivity. The greater the directivity of the device, the better the signal separation. System directivity is the vector sum of all leakage signals appearing at the analyzer receiver input. The error contributed by directivity is independent of the characteristics of the test device and it usually produces the major ambiguity in measurements of low reflection devices.

What is Measurement Calibration?**Source match**

Source match is defined as the vector sum of signals appearing at the analyzer receiver input, due to the impedance mismatch at the test device looking back into the source, as well as to adapter and cable mismatches and losses. In a reflection measurement, the source match error signal is caused by some of the reflected signal from the test device being reflected from the source back toward the test device and re-reflected from the test device (Figure 5-8). In a transmission measurement, the source match error signal is caused by reflection from the test device that is re-reflected from the source. Source match is most often given in terms of return loss in dB, the larger the number, the smaller the error.



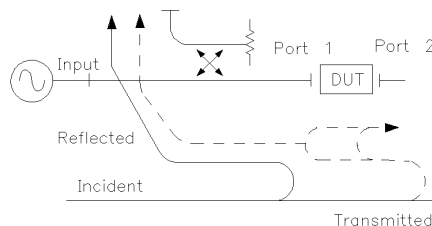
pg647d

Figure 5-8. Source Match

The error contributed by source match is dependent on the relationship between the actual input impedance of the test device and the equivalent match of the source. It is a factor in both transmission and reflection measurements. Source match is a particular problem in measurements where there is a large impedance mismatch at the measurement plane.

Load match

Load match error results from an imperfect match at the output of the test device. It is caused by impedance mismatches between the test device output port and port 2 of the measurement system. As shown in Figure 5-9, some of the transmitted signal is reflected from port 2 back to the test device. A portion of this wave may be re-reflected to port 2, or part may be transmitted through the device in the reverse direction to appear at port 1. If the test device has low insertion loss (for example, a transmission line), the signal reflected from port 2 and re-reflected from the source causes a significant error because the test device does not attenuate the signal significantly on each reflection. Load match is usually given in terms of return loss in dB, the larger the number, the smaller the error.



pg648d

Figure 5-9. Load Match

The error contributed by load match is dependent on the relationship between the actual output impedance of the test device and the effective match of the return port (port 2). It is a factor in all transmission measurements and in reflection measurements of two-port devices. Load match and source match are usually ignored when the test device insertion loss is greater than about 6 dB, because the error signal is greatly attenuated each time it passes through the test device. However, load match effects produce major transmission measurement errors for a test device with a highly reflective output port.

Isolation (crosstalk)

Leakage of energy between analyzer signal paths contributes to error in a transmission measurement, much like directivity does in a reflection measurement. Isolation is the vector sum of signals appearing at the analyzer samplers, due to crosstalk between the reference and test signal paths. This includes signal leakage within the test set and in both the RF and IF sections of the receiver.

The error contributed by isolation depends on the characteristics of the test device. Isolation is a factor in high-loss transmission measurements. However, analyzer system isolation is more than sufficient for most measurements, and correction for it may be unnecessary.

For measuring devices with high dynamic range, accuracy enhancement can provide improvements in isolation that are limited only by the noise floor. Generally, the isolation falls below the noise floor. Therefore, when performing an isolation calibration, you should use a noise reduction function such as averaging or reduce the IF bandwidth.

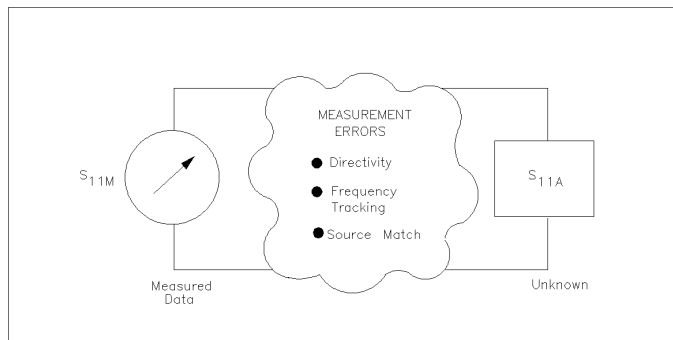
What is Measurement Calibration?**Frequency response (tracking)**

This is the vector sum of all test setup variations in which magnitude and phase change as a function of frequency. This includes variations contributed by signal-separation devices, test cables, and adapters, and variations between the reference and test signal paths. This error is a factor in both transmission and reflection measurements.

For further explanation of systematic error terms and the way they are combined and represented graphically in error models, refer to [“Characterizing microwave systematic errors”](#) on page 5-22.

Characterizing microwave systematic errors**One-port error model**

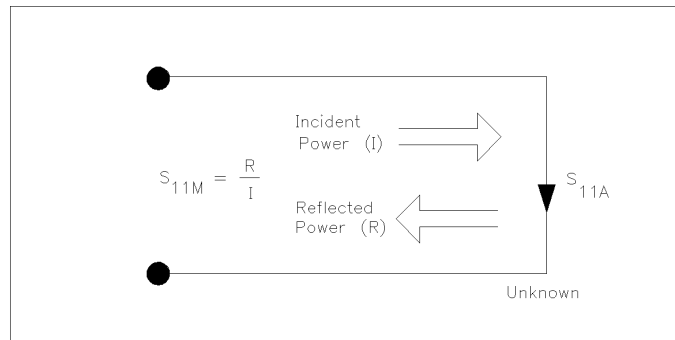
In a measurement of the reflection coefficient (magnitude and phase) of a test device, the measured data differs from the actual, no matter how carefully the measurement is made. Directivity, source match, and reflection signal path frequency response (tracking) are the major sources of error (refer to [Figure 5-10](#)).



pg649d

Figure 5-10. Sources of Error in a Reflection Measurement

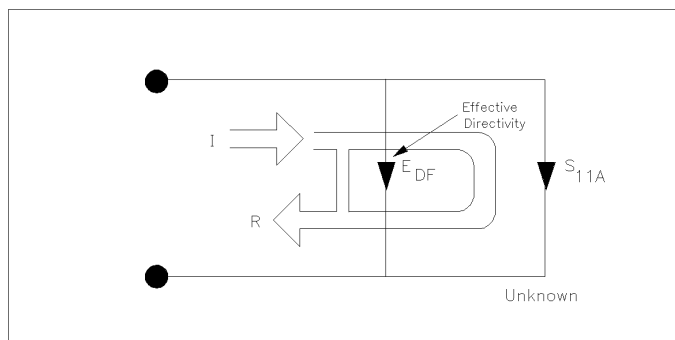
To characterize the errors, the reflection coefficient is measured by first separating the incident signal (I) from the reflected signal (R), then taking the ratio of the two values (refer to [Figure 5-11](#)). Ideally, (R) consists only of the signal reflected by the test device (S_{11A}).



pg650d

Figure 5-11. Reflection Coefficient

However, all of the incident signal does not always reach the unknown (refer to [Figure 5-12](#)). Some of (I) may appear at the measurement system input due to leakage through the test set or through a signal separation device. Also, some of (I) may be reflected by imperfect adapters between a signal separation device and the measurement plane. The vector sum of the leakage and the miscellaneous reflections is the effective directivity, E_{DF} . Understandably, the measurement is distorted when the directivity signal combines vectorally with the actual reflected signal from the unknown, S_{11A} .



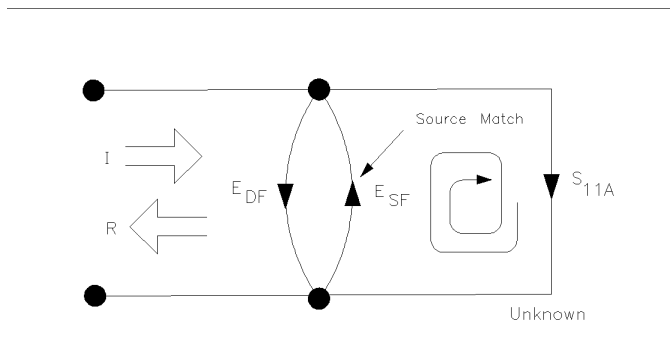
pg651d

Figure 5-12. Effective Directivity EDF

Since the measurement system test port is never exactly the characteristic impedance (50 ohms or 75 ohms), some of the reflected signal bounces off the test port, or other impedance transitions further down the line, and back to the unknown, adding to the original incident signal (I). This effect causes the

What is Measurement Calibration?

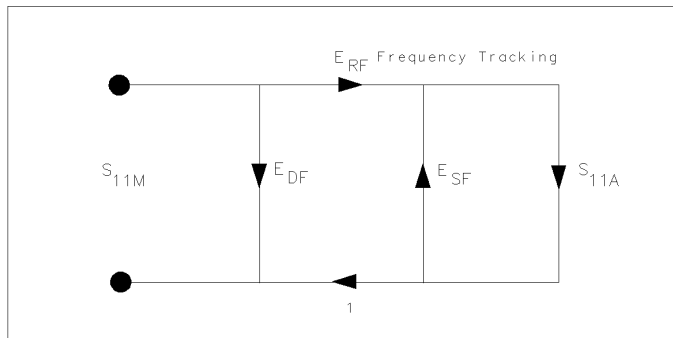
magnitude and phase of the incident signal to vary as a function of S_{11A} and frequency. Leveling the source to produce a constant incident signal (I) reduces this error, but since the source cannot be exactly leveled at the test device input, leveling cannot eliminate all power variations. This re-reflection effect and the resultant incident power variation are caused by the source match error, E_{SF} (refer to [Figure 5-13](#)).



pg652d

Figure 5-13. Source Match E_{SF}

Frequency response (tracking) error is caused by variations in magnitude and phase flatness versus frequency between the test and reference signal paths. These are due mainly to imperfectly matched samplers and differences in length and loss between the incident and test signal paths. The vector sum of these variations is the reflection signal path tracking error, E_{RF} (refer to [Figure 5-14](#)).



pg653d

Figure 5-14. Reflection Tracking E_{RF}

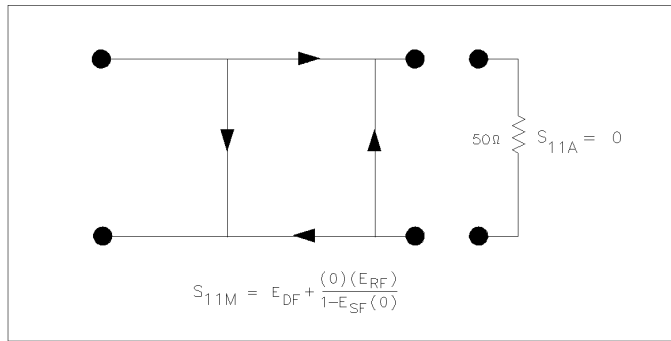
These three errors are mathematically related to the actual data, S_{11A} , and measured data, S_{11M} , by the following equation:

$$S_{11M} = E_{DF} + [(S_{11A} E_{RF}) / (1 - E_{SF} S_{11A})]$$

If the value of these three “E” errors and the measured test device response were known for each frequency, the above equation could be solved for S_{11A} to obtain the actual test device response. Because each of these errors changes with frequency, their values must be known at each test frequency. These values are found by measuring the system at the measurement plane using three independent standards whose S_{11A} is known at all frequencies.

The first standard applied is a “perfect load,” which makes $S_{11A} = 0$ and essentially measures directivity (refer to [Figure 5-15](#)). “Perfect load” implies a reflectionless termination at the measurement plane. All incident energy is absorbed. With $S_{11A} = 0$, the equation can be solved for E_{DF} , the directivity term. In practice, of course, the “perfect load” is difficult to achieve, although very good broadband loads are available in the Agilent 8702E-compatible calibration kits.

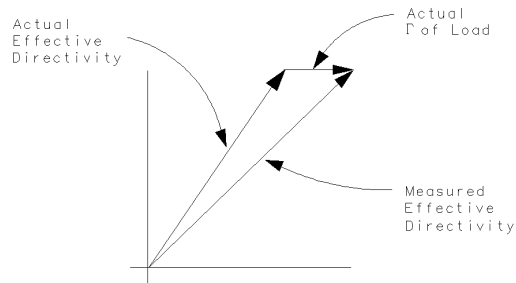
What is Measurement Calibration?



pg654d

Figure 5-15. "Perfect Load" Termination

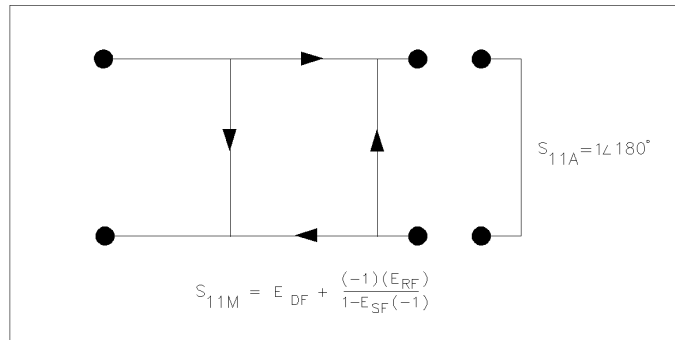
Since the measured value for directivity is the vector sum of the actual directivity plus the actual reflection coefficient of the "perfect load," any reflection from the termination represents an error. System effective directivity becomes the actual reflection coefficient of the "perfect load" (refer to Figure 5-16). In general, any termination having a return loss value greater than the uncorrected system directivity reduces reflection measurement uncertainty.



pg655d

Figure 5-16. Measured Effective Directivity

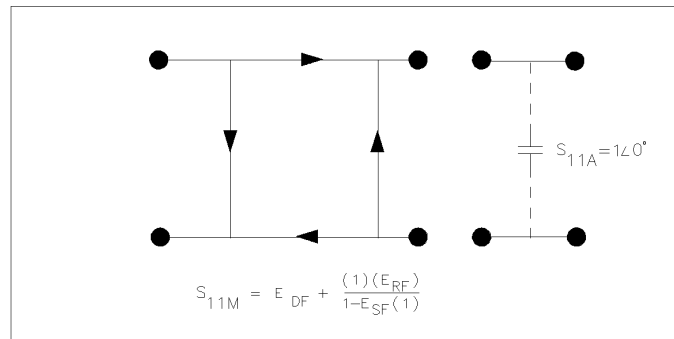
Next, a short circuit termination, whose response is known to a very high degree, is used to establish another condition (refer to Figure 5-17).



pg656d

Figure 5-17. Short Circuit Termination

The open circuit gives the third independent condition. In order to accurately model the phase variation with frequency due to radiation from the open connector, a specially designed shielded open circuit is used for this step. (The open circuit capacitance is different with each connector type.) Now the values for E_{DF} directivity, E_{SF} source match, and E_{RF} reflection frequency response are computed and stored (refer to [Figure 5-18](#)).

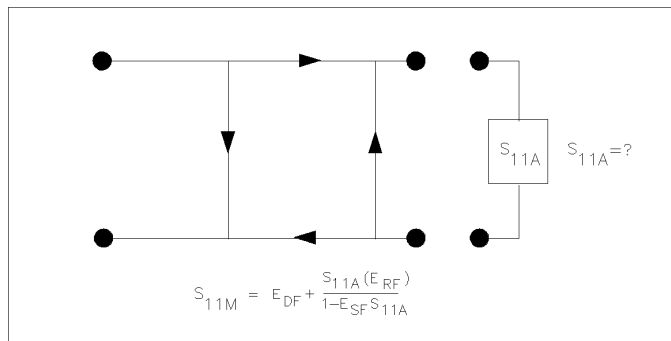


pg657d

Figure 5-18. Open Circuit Termination

Now the unknown is measured to obtain a value for the measured response, S_{11M} , at each frequency (refer to [Figure 5-19](#)).

What is Measurement Calibration?



pg658d

Figure 5-19. Measured S_{11}

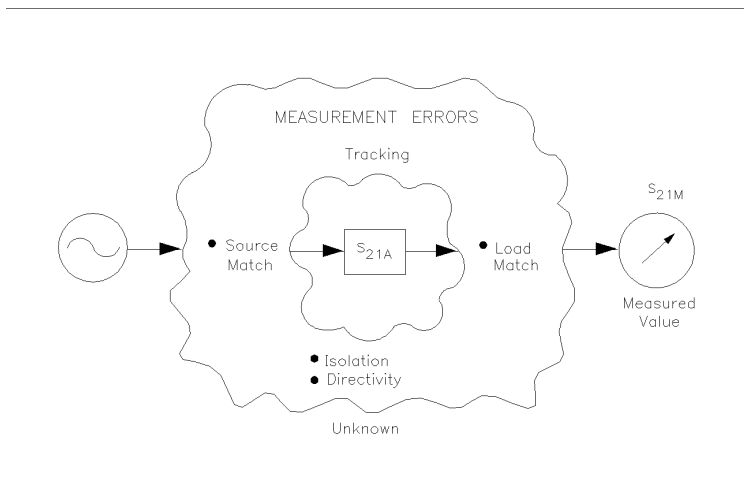
This is the one-port error model equation solved for S_{11A} . Since the three errors and S_{11M} are now known for each test frequency, S_{11A} can be computed as follows:

$$S_{11A} = S_{11M} - E_{DF} / [E_{SF} (S_{11M} - E_{DF}) + E_{RF}]$$

For reflection measurements on two-port devices, the same technique can be applied, but the test device output port must be terminated in the system characteristic impedance. This termination should have as low a reflection coefficient as the load used to determine directivity. The additional reflection error caused by an improper termination at the test device's output port is not incorporated into the one-port error model.

Two-port error model

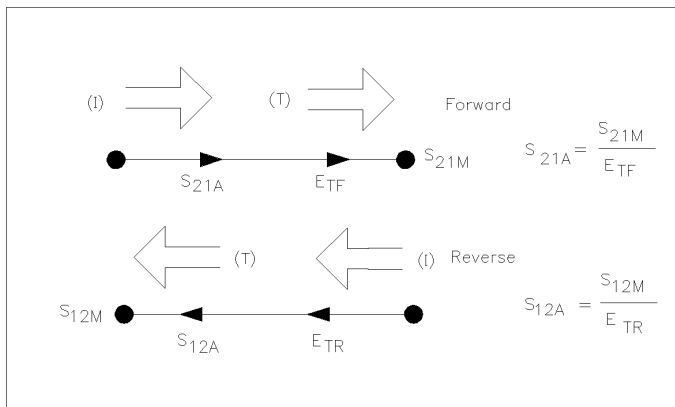
The error model for measurement of the transmission coefficients (magnitude and phase) of a two-port device is derived in a similar manner. The potential sources of error are frequency response (tracking), source match, load match, and isolation (refer to [Figure 5-20](#)). These errors are effectively removed using the full two-port error model.



pg659d

Figure 5-20. Major Sources of Error

The transmission coefficient is measured by taking the ratio of the incident signal (I) and the transmitted signal (T) (refer to [Figure 5-21](#)). Ideally, (I) consists only of power delivered by the source, and (T) consists only of power emerging at the test device output.

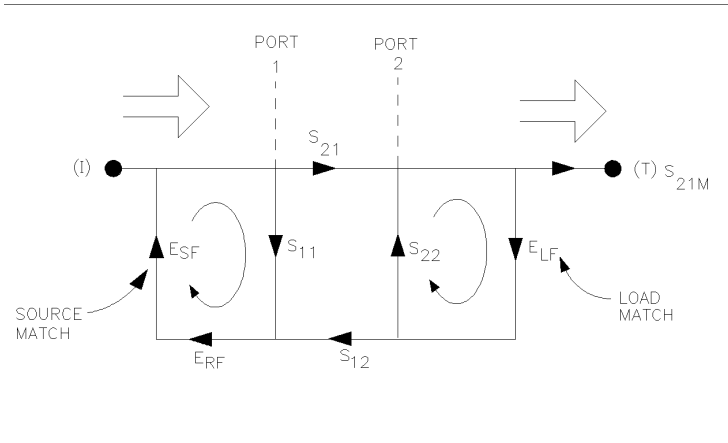


pg660d

Figure 5-21. Transmission Coefficient

What is Measurement Calibration?

As in the reflection model, source match can cause the incident signal to vary as a function of test device $S_{11}A$. Also, since the test setup transmission return port is never exactly the characteristic impedance, some of the transmitted signal is reflected from the test set port 2, and from other mismatches between the test device output and the receiver input, to return to the test device. A portion of this signal may be re-reflected at port 2, thus affecting $S_{21}M$, or part may be transmitted through the device in the reverse direction to appear at port 1, thus affecting $S_{11}M$. This error term, which causes the magnitude and phase of the transmitted signal to vary as a function of $S_{22}A$, is called load match, E_{LF} (refer to Figure 5-22).



pg661d

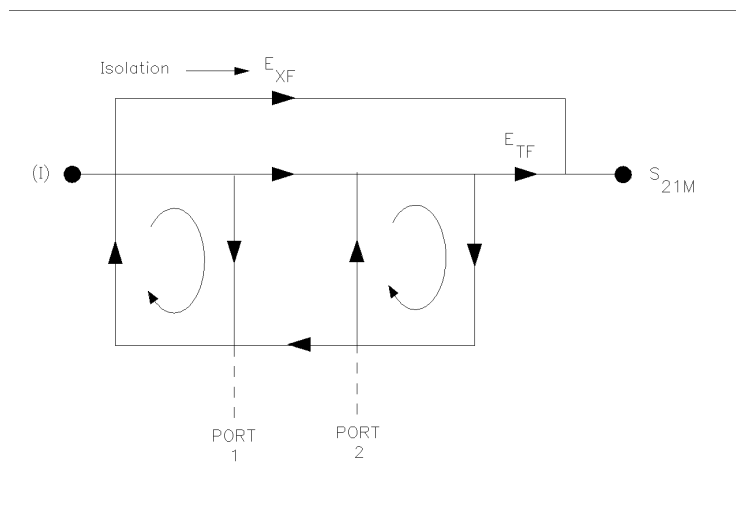
Figure 5-22. Load Match E_{LF}

The measured value, $S_{21}M$, consists of signal components that vary as a function of the relationship between E_{SF} and $S_{11}A$, as well as E_{LF} and $S_{22}A$, so the input and output reflection coefficients of the test device must be measured and stored for use in the $S_{21}A$ error correction computation. Thus, the test setup is calibrated as described above for reflection to establish the directivity, E_{DF} , source match, E_{SF} , and reflection frequency response, E_{RF} , terms for the reflection measurements.

Now that a calibrated port is available for reflection measurements, the thru is connected and load match, E_{LF} , is determined by measuring the reflection coefficient of the thru connection.

Transmission signal path frequency response is then measured with the thru connected. The data is corrected for source and load match effects, then stored as transmission frequency response, E_{TF} .

Isolation, E_{XF} , represents the part of the incident signal that appears at the receiver without actually passing through the test device (refer to [Figure 5-23](#)). Isolation is measured with the test set in the transmission configuration and with terminations installed at the points where the test device will be connected.



pg662c

Figure 5-23. Isolation E_{XF}

There are two sets of error terms, forward and reverse, with each set consisting of six error terms, as follows:

- Directivity, E_{DF} (forward) and E_{DR} (reverse)
- Isolation, E_{XF} and E_{XR}
- Source Match, E_{SF} and E_{SR}
- Load Match, E_{LF} and E_{LR}
- Transmission Tracking, E_{TF} and E_{TR}
- Reflection Tracking, E_{RF} and E_{RR}

The Agilent 8702E's built-in S-parameter test set can measure both the forward and reverse characteristics of the test device without the need to manually remove and physically reverse the device. The full two-port error model illustrated in [Figure 5-24](#) effectively removes both the forward and reverse error terms for transmission and reflection measurements.

What is Measurement Calibration?

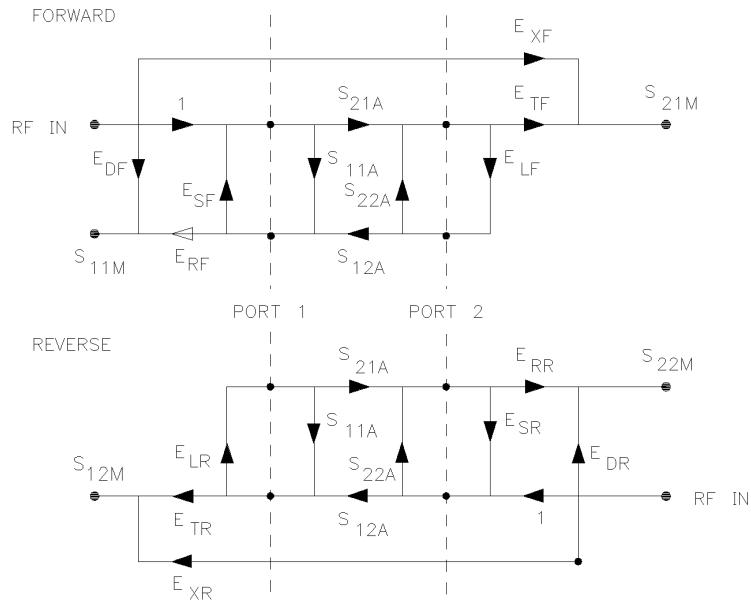


Figure 5-24. Full Two-Port Error Model

Figure 5-25 shows the full two-port error model equations for all four S-parameters of a two-port device. Note that the mathematics for this comprehensive model use all forward and reverse error terms and measured values. Thus, to perform full error correction for any one parameter, all four S-parameters must be measured.

Applications of these error models are provided in the calibration procedures described in the *Agilent 8702E User's Guide*.

$$S_{11A} = \frac{\left[\left(\frac{S_{11M} - E_{DF}}{E_{RF}} \right) \left[1 + \left(\frac{S_{22M} - E_{DR}}{E_{RR}} \right) E_{SR} \right] \right] - \left[\left(\frac{S_{21M} - E_{XF}}{E_{TF}} \right) \left(\frac{S_{12M} - E_{XR}}{E_{TR}} \right) E_{LF} \right]}{\left[1 + \left(\frac{S_{11M} - E_{DF}}{E_{RF}} \right) E_{SF} \right] \left[1 + \left(\frac{S_{22M} - E_{DR}}{E_{RR}} \right) E_{SR} \right] - \left[\left(\frac{S_{21M} - E_{XF}}{E_{TF}} \right) \left(\frac{S_{12M} - E_{XR}}{E_{TR}} \right) E_{LF} E_{LR} \right]}$$

$$S_{21A} = \frac{\left[1 + \left(\frac{S_{22M} - E_{DR}}{E_{RR}} \right) \left(E_{SR} - E_{LF} \right) \right] \left(\frac{S_{21M} - E_{XF}}{E_{TF}} \right)}{\left[1 + \left(\frac{S_{11M} - E_{DF}}{E_{RF}} \right) E_{SF} \right] \left[1 + \left(\frac{S_{22M} - E_{DR}}{E_{RR}} \right) E_{SR} \right] - \left[\left(\frac{S_{21M} - E_{XF}}{E_{TF}} \right) \left(\frac{S_{12M} - E_{XR}}{E_{TR}} \right) E_{LF} E_{LR} \right]}$$

$$S_{12A} = \frac{\left[1 + \left(\frac{S_{11M} - E_{DF}}{E_{RF}} \right) \left(E_{SF} - E_{LR} \right) \right] \left(\frac{S_{12M} - E_{XR}}{E_{TR}} \right)}{\left[1 + \left(\frac{S_{11M} - E_{DF}}{E_{RF}} \right) E_{SF} \right] \left[1 + \left(\frac{S_{22M} - E_{DR}}{E_{RR}} \right) E_{SR} \right] - \left[\left(\frac{S_{21M} - E_{XF}}{E_{TF}} \right) \left(\frac{S_{12M} - E_{XR}}{E_{TR}} \right) E_{LF} E_{LR} \right]}$$

$$S_{22A} = \frac{\left[\left(\frac{S_{22M} - E_{DR}}{E_{RR}} \right) \left[1 + \left(\frac{S_{11M} - E_{DF}}{E_{RF}} \right) E_{SF} \right] \right] - \left[\left(\frac{S_{21M} - E_{XF}}{E_{TF}} \right) \left(\frac{S_{12M} - E_{XR}}{E_{TR}} \right) E_{LR} \right]}{\left[1 + \left(\frac{S_{11M} - E_{DF}}{E_{RF}} \right) E_{SF} \right] \left[1 + \left(\frac{S_{22M} - E_{DR}}{E_{RR}} \right) E_{SR} \right] - \left[\left(\frac{S_{21M} - E_{XF}}{E_{TF}} \right) \left(\frac{S_{12M} - E_{XR}}{E_{TR}} \right) E_{LF} E_{LR} \right]}$$

pg6128d

Figure 5-25. Full Two-Port Error Model Equations

What is Measurement Calibration?

In addition to the errors removed by accuracy enhancement, other systematic errors exist due to limitations of dynamic accuracy, test set switch repeatability, and test cable stability. These, combined with random errors, also contribute to total system measurement uncertainty. Therefore, after accuracy enhancement procedures are performed, residual measurement uncertainties remain.

Correcting for measurement errors

The CAL key leads to a series of menus that implement the accuracy enhancement concepts described in this section. Accuracy enhancement (error correction) is performed as a calibration step before measurement of a test device.

There are twelve different error terms for a two-port measurement that can be corrected by accuracy enhancement in the analyzer. These are directivity, source match, load match, isolation, reflection tracking, and transmission tracking, each in both the forward and reverse direction. The analyzer has several different measurement calibration routines to characterize one or more of the systematic error terms and remove their effects from the measured data. The procedures range from a simple frequency response calibration to a full two-port calibration that effectively removes all twelve error terms.

Response calibration

The response calibration provides a normalization of the test setup for reflection or transmission measurements. This calibration procedure may be adequate for measurement of well matched low-loss devices. This is the simplest error correction to perform, and should be used when extreme measurement accuracy is not required.

Response and isolation calibration

The response and isolation calibration provides a normalization for frequency response and crosstalk errors in transmission measurements, or frequency response and directivity errors in reflection measurements. This procedure may be adequate for measurement of well matched high-loss devices.

 S_{11} and S_{22} one-port calibration

The S_{11} and S_{22} one-port calibration procedures provide directivity, source match, and frequency response vector error correction for reflection measurements. These procedures provide high accuracy reflection measurements of one-port devices or properly terminated two-port devices.

Full two-port calibration

The full two-port calibration provides directivity, source match, load match, isolation, and frequency response vector error correction, in both forward and reverse directions, for transmission and reflection measurements of two-port devices. This calibration provides the best magnitude and phase measurement accuracy for both transmission and reflection measurements of two-port devices, and requires an S-parameter test set.

One-path two-port calibration

The one-path two-port calibration provides directivity, source match, load match, isolation, and frequency response vector error correction in one direction. It is used for high accuracy transmission and reflection measurements. You must use a full 2-port measurement calibration and put the analyzer in the test set hold mode to use this feature. You can access the test set hold mode by pressing, *CAL*, *MORE*, *TESTSET SW HLD*.

How effective is accuracy enhancement?

The uncorrected performance of the analyzer is sufficient for many measurements. However, the vector accuracy enhancement procedures, described in the *Agilent 8702E User's Guide*, will provide a much higher level of accuracy. [Figure 5-26](#) through [Figure 5-28](#) illustrate the improvements that can be made in measurement accuracy by using a more complete calibration routine. [Figure 5-26a](#) shows a measurement in log magnitude format with a response calibration only. [Figure 5-26b](#) shows the improvement in the same measurement using an S_{11} one-port calibration. [Figure 5-27a](#) shows the measurement on a Smith chart with response calibration only, and [Figure 5-27b](#) shows the same measurement with an S_{11} one-port calibration.

What is Measurement Calibration?

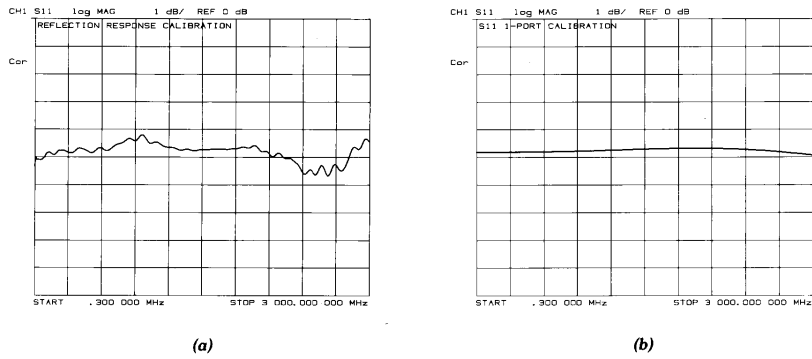


Figure 5-26. (a) Response versus S_{11} , (b) 1-Port Calibration on Log Magnitude Format

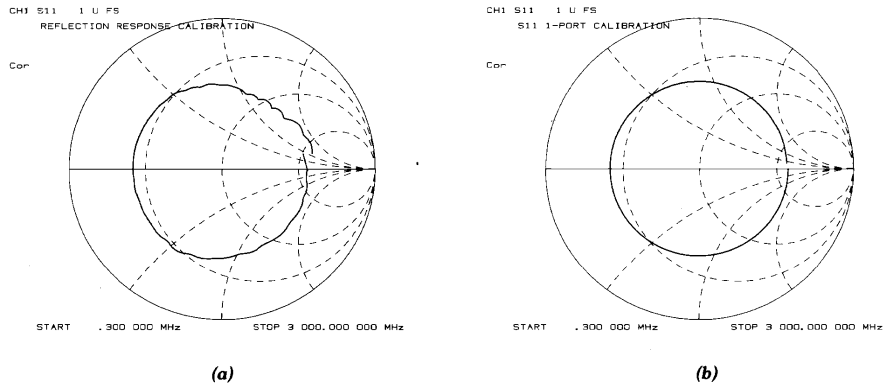


Figure 5-27. (a) Response versus S_{11} , (b) 1-Port Calibration on Smith Chart

Figure 5-28 shows the response of a low-loss device in a log magnitude format, using a response calibration in Figure 5-28a and a full two-port calibration in Figure 5-28b.

pg6167_c

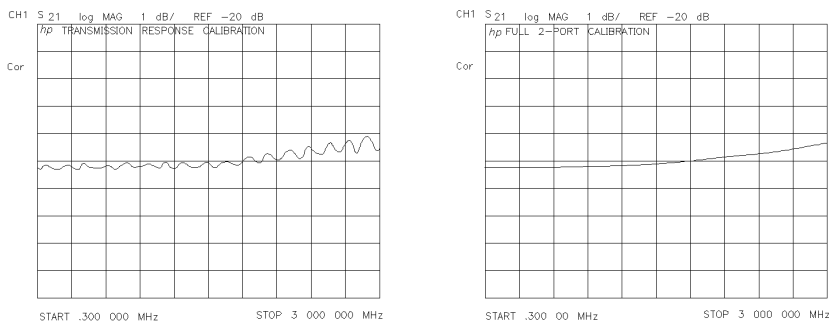


Figure 5-28. Response versus Full Two-Port Calibration

Ensuring a valid calibration

Unless interpolated error correction is on, measurement calibrations are valid only for a specific stimulus state, which must be set before calibration is begun. The stimulus state consists of the selected frequency range, number of points, sweep time, temperature, output power, and sweep type. Changing the frequency range, number of points, or sweep type with correction on invalidates the calibration and turns it off. Changing the sweep time or output power changes the status notation **Cor**, at the left of the screen, to **C?**, to indicate that the calibration is in question. If correction is turned off or in question after the stimulus changes are made, pressing **CORRECTION ON** recalls the original stimulus state for the current calibration.

Interpolated error correction

The interpolated error correction feature allows you to select a subset of the frequency range or a different number of points without recalibration. Interpolation is activated by a softkey. When interpolation is on, the system errors for the newly selected frequencies are calculated from the system errors of the original calibration.

System performance is unspecified when using interpolated error correction. The quality of the interpolated error correction is dependent on the amount of phase shift and the amplitude change between measurement points. If phase shift is no greater than 180° per approximately 5 measurement points, interpolated error correction offers a great improvement over uncorrected measurements. The accuracy of interpolated error correction improves as the phase shift and amplitude change between adjacent points decrease. When

What is Measurement Calibration?

you use the analyzer in linear frequency sweep, perform the original calibration with at least 67 points per 1 GHz of frequency span for greatest accuracy with interpolated error correction.

Interpolated error correction functions in three sweep modes: linear frequency, power sweep, and CW time.

If there is a valid correction array for a linear frequency sweep, this may be interpolated to provide correction at the CW frequency used in power sweep or CW time modes. This correction is part of the interpolated error correction feature and is not specified.

Channel coupling Up to two sets of measurement calibration data can be defined for each instrument state, one for each channel. If the two channels are stimulus coupled and the input ports are the same for both channels, they share the same calibration data. If the two channel inputs are different, they can have different calibration data. If the two channels are stimulus uncoupled, the measurement calibration applies to only one channel.

Measurement parameters Calibration procedures are parameter-specific, rather than channel-specific. When a parameter is selected, the instrument checks the available calibration data, and uses the data found for that parameter. For example, if a transmission response calibration is performed for B/R, and an S_{11} 1-port calibration for A/R, the analyzer retains both calibration sets and corrects whichever parameter is displayed. Once a calibration has been performed for a specific parameter or input, measurements of that parameter remain calibrated in either channel, as long as stimulus values are coupled. In the response and response and isolation calibrations, the parameter must be selected before calibration: other correction procedures select parameters automatically. Changing channels during a calibration procedure invalidates the part of the procedure already performed.

Device measurements In calibration procedures that require measurement of several different devices, for example a short, an open, and a load, the order in which the devices are measured is not critical. Any standard can be remeasured, until the *DONE* key is pressed. The change in trace during measurement of a standard is normal.

Response and response and isolation calibrations require measurement of only one standard device. If more than one device is measured, only the data for the last device is retained.

- Omitting isolation calibration** Isolation calibration can be omitted for most measurements, except where wide dynamic range is a consideration. Use the following guidelines. When the measurement requires a dynamic range of:
- 80 dB: Omit isolation calibration for most measurements.
 - 80 to 100 dB: Isolation calibration is recommended with approximately 0 dBm into the R input. If an isolation calibration is used, averaging should be turned on with an averaging factor of 16 for the isolation calibration, and four for the measurement after calibration.
 - 100 dB: Averaging should be turned on with an averaging factor of 16, both for the isolation calibration and for the measurement after calibration.
- Restarting a calibration** If you interrupt a calibration to go to another menu, you can continue the calibration by pressing the *RESUME CAL SEQUENCE* softkey in the correction menu.
- Saving calibration data** You should save the calibration data, either in the internal non-volatile memory or on a disk. If you do not save it, it will be lost if you select another calibration procedure for the same channel, or if you change stimulus values. Instrument preset, power on, and instrument state recall will also clear the calibration data.

The calibration standards

During measurement calibration, the analyzer measures actual, well-defined standards and mathematically compares the results with ideal “models” of those standards. The differences are separated into error terms which are later removed during error correction. Most of the differences are due to systematic errors, repeatable errors introduced by the analyzer, test set, and cables, which are correctable.

The standard devices required for system calibration are available in compatible calibration kits with different connector types. Each kit contains at least one short circuit, one open circuit, and two impedance-matched loads. In kits that require adapters for interface to the test set ports, the adapters are phase-matched for calibration prior to measurement of non-insertable and non-reversible devices. Other standard devices can be used by specifying their characteristics in a user-defined kit, as described in [“Modifying calibration kits” on page 5-43](#).

What is Measurement Calibration?

The accuracy improvement of the correction is limited by the quality of the standard devices, and by the connection techniques used. For maximum accuracy, use a torque wrench for final connections.

Frequency response of calibration standards

In order for the response of a reference standard to indicate as a dot on the display, it must have no phase shift with respect to frequency. Standards that exhibit such “perfect” response are the following:

- 7 mm short (with no offset)
- type-N male short (with no offset)

There are two reasons why other types of reference standards show phase shift after calibration:

- The reference plane of the standard is electrically offset from the mating plane of the test port. Such devices exhibit the properties of a small length of transmission line, including a certain amount of phase shift.
- The standard is an open termination, which by definition exhibits a certain amount of fringe capacitance (and therefore phase shift). Open terminations which are offset from the mating plane will exhibit a phase shift due to the offset in addition to the phase shift caused by the fringe capacitance.

The most important point to remember is that these properties will not affect your measurements. The analyzer compensates for them during measurement. [Figure 5-29 on page 5-42](#) shows sample displays of various calibration standards after calibration.

Electrical Offset

Some standards have reference planes that are electrically offset from the mating plane of the test port. These devices will show a phase shift with respect to frequency. [Table 5-2 on page 5-41](#) shows which reference devices exhibit an electrical offset phase shift. The amount of phase shift can be calculated with the formula:

$$\phi = (360 \times f \times l) / c$$

where:

f = frequency

l = electrical length of the offset

c = speed of light (3×10^8 meters/second)

Fringe capacitance

All open circuit terminations exhibit a phase shift over frequency due to fringe capacitance. Offset open circuits have increased phase shift because the offset

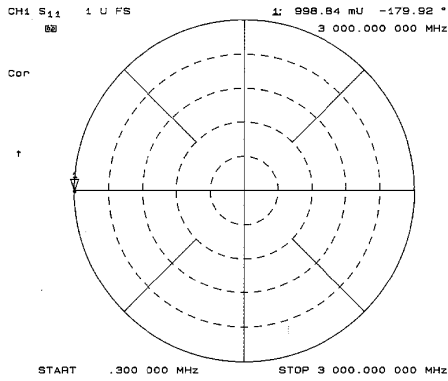
acts as a small length of transmission line. Refer to [Table 5-2](#).

Table 5-2. Calibration Standard Types and Expected Phase Shift

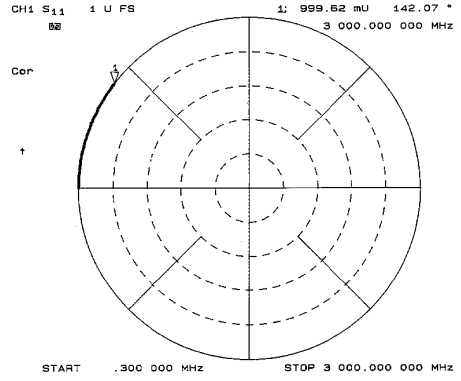
Test Port Connector Type	Standard Type	Expected Phase Shift
7 mm Type N male	Short	180°
3.5 mm male 3.5 mm female Type N female	Offset Short	$180^\circ + (360 \times f \times l)/c$
7 mm Type N male	Open	$0^\circ + \phi_{\text{capacitance}}$
3.5 mm male 3.5 mm female Type N female	Offset Open	$0^\circ + \phi_{\text{capacitance}} + (360 \times f \times l)/c$
	Open	$0^\circ + \phi_{\text{capacitance}} + (360 \times f \times l)/c$

Concepts

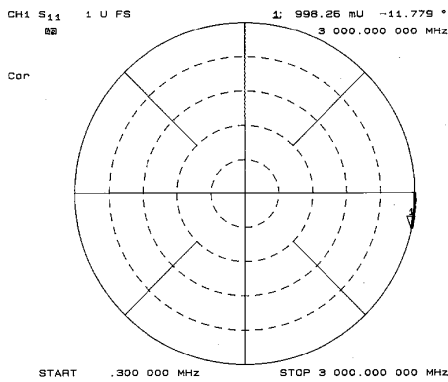
What is Measurement Calibration?



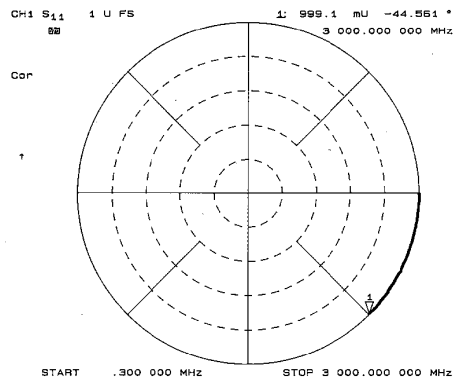
**7 mm or Type-N Male
Short (No Offset)**



**Type-N Female,
3.5 mm Male or Female Offset Short**



**7 mm or Type-N Male
Open (No Offset)**



**Type-N Female,
3.5 mm Male or Female Offset Open**

pg6185_c

Figure 5-29. Typical Responses of Calibration Standards after Calibration

Specifying calibration kits

In addition to the menus for the different calibration procedures, the CAL key provides access to a series of menus used to specify the characteristics of calibration standards. Several default calibration kits with different connector types have predefined standards and are valid for most applications. The numerical definitions for most Agilent Technologies calibration kits can be referenced in the calibration kit operating and service manuals, or can be viewed on the analyzer. The standard definitions can also be modified to any set of standards used.

Modifying calibration kits

Modifying calibration kits is necessary only if unusual standards (such as in TRL*) are used or the very highest accuracy is required. Unless a calibration kit model is provided with the calibration devices used, a solid understanding of error correction and the system error model are absolutely essential to making modifications.

To improve your understanding of modifying calibration kits, you should read *Application Note 8510-5A*, Agilent Technologies part number 5956-4352, before attempting to modify calibration standard definitions. Although the application note is written for the Agilent 8510 family of network analyzers, it also applies to the Agilent 8702E.

Several situations exist that may require a user-defined calibration kit:

- A calibration is required for a connector interface different from the four default calibration kits. (Examples: SMA, TNC, or waveguide.)
- A calibration with standards (or combinations of standards) that are different from the default calibration kits is required. (Example: Using three offset shorts instead of open, short, and load to perform a 1-port calibration.)
- The built-in standard models for default calibration kits can be improved or refined. Remember that the more closely the model describes the actual performance of the standard, the better the calibration. (Example: The 7 mm load is determined to be 50.4 ohms instead of 50.0 ohms.)

Definitions

The following are definitions of terms:

- A “standard” is a specific, well-defined, physical device used to determine systematic errors.
- A standard “type” is one of five basic types that define the form or structure of

What is Measurement Calibration?

the model to be used with that standard (for example, short or load).

- Standard “coefficients” are numerical characteristics of the standards used in the model selected.
- A standard “class” is a grouping of one or more standards that determines which standards are used in a particular calibration procedure.

Procedure

The following steps are used to modify or define a user kit:

- 1** To modify a cal kit, first select the predefined kit to be modified. This is not necessary for defining a new cal kit.
- 2** Define the standards. For each standard, define which “type” of standard it is and its electrical characteristics.
- 3** Specify the class where the standard is to be assigned.
- 4** Store the modified cal kit.

Refer to [“Using the front panel to examine or modify calibration constants” on page 5-53](#) for detailed instructions.

Modify calibration kit menu

This menu is accessed from the CAL key. This leads, in turn, to additional series of menus associated with modifying cal kits.

DEFINE STANDARD makes the standard number the active function, and brings up the define standard menus. The standard number (1 to 8) is an arbitrary reference number used to reference standards while specifying a class. The standard numbers for the predefined calibration kits are as follows:

1	short
2	open
3	broadband load
4	thru
5	sliding load
6	lowband load
7	short
8	open

<i>SPECIFY CLASS</i>	leads to the specify class menu. After the standards are modified, use this key to specify a class to consist of certain standards.
<i>LABEL CLASS</i>	leads to the label class menu, to give the class a meaningful label for future reference.
<i>LABEL KIT</i>	leads to a menu for constructing a label for the user-modified cal kit. If a label is supplied, it will appear as one of the five softkey choices in the select cal kit menu. The approach is similar to defining a display title, except that the kit label is limited to ten characters.
<i>KIT DONE</i>	terminates the cal kit modification process, after all standards are defined and all classes are specified. Be sure to save the kit with the <i>SAVE USER KIT</i> softkey, if it is to be used later.

Define standard menus

Standard definition is the process of mathematically modeling the electrical characteristics (delay, attenuation, and impedance) of each calibration standard. These electrical characteristics (coefficients) can be mathematically derived from the physical dimensions and material of each calibration standard, or from its actual measured response. The parameters of the standards can be listed in [Table 5-3](#).

What is Measurement Calibration?

Table 5-3. Standard Definitions

System Z_0 ^a = _____

Disk File Name: _____ **Calibration Kit Label:** _____

Standard ^b	C0 x $10^{-15}F$	C1 x $10^{-27}F/Hz$	C2 x $10^{-36}F/Hz^2$	C3 x $10^{-45}F/Hz^3$	Fixed ^c or Sliding	Term ^d Imped Ω	Offset		Freq (GHz)		Coax or WG	Std Label
							Delay s	Z_0 Ω	Loss Ω/s	Min		
1												
2												
3												
4												
5												
6												
7												
8												

- a. Ensure system Z_0 of analyzer is set to this value.
- b. Open, short, load, delay/thru, or arbitrary impedance.
- c. Load or arbitrary impedance only.
- d. Arbitrary impedance only, device terminating impedance.

Each standard must be identified as one of five “types”: open, short, load, delay/thru, or arbitrary impedance.

After a standard number is entered, selection of the standard type will present one of five menus for entering the electrical characteristics (model coefficients) corresponding to that standard type. These menus are tailored to the current type, so that only characteristics applicable to the standard type can be modified.

Any standard type can be further defined with offsets in delay, loss, and standard impedance; assigned minimum or maximum frequencies over which the standard applies; and defined as coax or waveguide. Press the *SPECIFY OFFSET* key, and refer to the specify offset menu.

A distinct label can be defined and assigned to each standard, so that the analyzer can prompt the user with explicit standard labels during calibration (for example, “SHORT”). Press the *LABEL STD* softkey. The function is similar to defining a display title, except that the label is limited to ten characters.

After each standard is defined, including offsets, press *STD DONE (DEFINED)* to terminate the standard definition.

OPEN defines the standard type as an open, used for calibrating reflection measurements. Opens are assigned a terminal impedance of infinite ohms, but delay and loss offsets may still be added. Pressing this key also brings up a menu for defining the open, including its capacitance.

As a reflection standard, an open termination offers the advantage of broadband frequency coverage. At microwave frequencies, however, an open rarely has perfect reflection characteristics because fringing (capacitance) effects cause phase shift that varies with frequency. This can be observed in measuring an open termination after calibration, when an arc in the lower right circumference of the Smith chart indicates capacitive reactance. These effects are impossible to eliminate, but the calibration kit models include the open termination capacitance at all frequencies for compatible calibration kits. The capacitance model is a cubic polynomial, as a function of frequency, where the polynomial coefficients are user-definable. The capacitance model equation is:

$$C = (C0) + (C1 \times F) + (C2 \times F^2) + (C3 \times F^3)$$

where: F is the measurement frequency

The terms in the equation are defined with the specify open menu as follows:

<i>C0</i>	used to enter the C0 term, which is the constant term of the cubic polynomial and is scaled by 10^{-15} Farads.
<i>C1</i>	used to enter the C1 term, expressed in F/Hz (Farads/Hz) and scaled by 10^{-27} .
<i>C2</i>	used to enter the C2 term, expressed in F/Hz ² and scaled by 10^{-36} .
<i>C3</i>	used to enter the C3 term, expressed in F/Hz ³ and scaled by 10^{-45} .
<i>SHORT</i>	defines the standard type as a short, for calibrating reflection measurements. Shorts are assigned a terminal impedance of 0 ohms, but delay and loss offsets may still be added.
<i>LOAD</i>	defines the standard type as a load (termination). Loads are assigned a terminal impedance equal to the system characteristic impedance Z0, but delay and loss offsets may still be added. If the load impedance is not Z0, use the arbitrary impedance standard definition.
<i>FIXED</i>	defines the load as a fixed (not sliding) load.

What is Measurement Calibration?

<i>SLIDING</i>	defines the load as a sliding load. When such a load is measured during calibration, the analyzer will prompt for several load positions, and calculate the ideal load value from it.
<i>DELAY/THRU</i>	defines the standard type as a transmission line of specified length, for calibrating transmission measurements.
<i>ARBITRARY IMPEDANCE</i>	defines the standard type to be a load, but with an arbitrary impedance (different from system Z_0).
<i>TERMINAL IMPEDANCE</i>	used to specify the (arbitrary) impedance of the standard, in ohms.
<i>FIXED</i>	defines the load as a fixed (not sliding) load.
<i>SLIDING</i>	defines the load as a sliding load. When such a load is measured during calibration, the analyzer will prompt for several load positions, and calculate the ideal load value from it.

Specify offset menu

The specify offset menu allows additional specifications for a user-defined standard. Features specified in this menu are common to all five types of standards.

Offsets may be specified with any standard type. This means defining a uniform length of transmission line to exist between the standard being defined and the actual measurement plane. (Example: a waveguide short circuit terminator, offset by a short length of waveguide.) For reflection standards, the offset is assumed to be between the measurement plane and the standard (one-way only). For transmission standards, the offset is assumed to exist between the two reference planes (in effect, the offset is the thru). Three characteristics of the offset can be defined: its delay (length), loss, and impedance.

In addition, the frequency range over which a particular standard is valid can be defined with a minimum and maximum frequency. This is particularly important for a waveguide standard, since its behavior changes rapidly beyond its cutoff frequency. Note that several band-limited standards can together be defined as the same "class" (see specify class menu). Then, if a measurement calibration is performed over a frequency range exceeding a single standard, additional standards can be used for each portion of the range.

Lastly, the standard must be defined as either coaxial or waveguide. If it is waveguide, dispersion effects are calculated automatically and included in the standard model.

OFFSET DELAY used to specify the one-way electrical delay from the measurement (reference) plane to the standard, in seconds (s). (In a transmission standard, offset delay is the delay from plane to plane.) Delay can be calculated from the precise physical length of the offset, the permittivity constant of the medium, and the speed of light.

In coax, group delay is considered constant. In waveguide, however, group delay is dispersive, that is, it changes significantly as a function of frequency. Hence, for a waveguide standard, offset delay must be defined at an infinitely high frequency.

OFFSET LOSS used to specify energy loss, due to skin effect, along a one-way length of coax offset. The value of loss is entered as ohms/nanosecond (or Giga ohms/second) at 1 GHz. (Such losses are negligible in waveguide, so enter 0 as the loss offset.)

OFFSET Z0 used to specify the characteristic impedance of the coax offset. (Note: This is not the impedance of the standard itself.) (For waveguide, the offset impedance is always assigned a value equal to the system Z0.)

MINIMUM FREQUENCY used to define the lowest frequency at which the standard can be used during measurement calibration. In waveguide, this must be the lower cutoff frequency of the standard, so that the analyzer can calculate dispersive effects correctly (refer to *OFFSET DELAY* above).

MAXIMUM FREQUENCY used to define the highest frequency at which the standard can be used during measurement calibration. In waveguide, this is normally the upper cutoff frequency of the standard.

COAX defines the standard (and the offset) as coaxial. This causes the analyzer to assume linear phase response in any offsets.

WAVEGUIDE defines the standard (and the offset) as rectangular waveguide. This causes the analyzer to assume a dispersive

What is Measurement Calibration?

delay (refer to *OFFSET DELAY* above).

Label standard menu

This menu is used to label (reference) individual standards during the menu-driven measurement calibration sequence. The labels are user-definable using a character set shown on the display that includes letters, numbers, and some symbols, and they may be up to ten characters long. The analyzer will prompt you to connect standards using these labels, so they should be meaningful to you, and distinct for each standard.

By convention, when sexed connector standards are labeled male (m) or female (f), the designation refers to the test port connector sex, not the connector sex of the standard.

Specify class menus

Once a standard is specified, it must be assigned to a standard “class”. This is a group of from one to seven standards that is required to calibrate for a single error term. The standards within a single class are assigned to locations A through G as listed in [Table 5-4](#). A class often consists of a single standard, but may be composed of more than one standard if band-limited standards are used. (Example: All default calibration kits for the analyzer have a single load standard per class, since all are broadband in nature. However, if there were two load standards - a fixed load for low frequencies, and a sliding load for high frequencies - then that class would have two standards.)

Table 5-4. Standard Class Assignments

Calibration Kit Label: _____								
Disk File Name: _____								
Class	A	B	C	D	E	F	G	Standard Class Label
S ₁₁ A								
S ₁₁ B								
S ₁₁ C								
S ₂₂ A								
S ₂₂ B								
S ₂₂ C								
Forward Transmission								
Reverse Transmission								
Forward Match								
Reverse Match								

Table 5-4. Standard Class Assignments

Calibration Kit Label: _____								
Disk File Name: _____								
Class	A	B	C	D	E	F	G	Standard Class Label
Response								
Response and Isolation								

The number of standard classes required depends on the type of calibration being performed, and is identical to the number of error terms corrected. (Examples: A response cal requires only one class, and the standards for that class may include an open, or short, or thru. A 1-port cal requires three classes. A full 2-port cal requires 10 classes, not including two for isolation.) The number of standards that can be assigned to a given class may vary from none (class not used) to one (simplest class) to seven. When a certain class of standards is required during calibration, the analyzer will display the labels for all the standards in that class (except when the class consists of a single standard). This does not, however, mean that all standards in a class must be measured during calibration. Unless band-limited standards are used, only a single standard per class is required. Note that it is often simpler to keep the number of standards per class to the bare minimum needed (often one) to avoid confusion during calibration.

Standards are assigned to a class simply by entering the standard's reference number (established while defining a standard) under a particular class.

Each class can be given a user-definable label as described under the Label Class Menus.

S11A RE SW MTCH used to enter the standard numbers for the first class required for an S_{11} 1-port calibration. (For default cal kits, this is the open.)

S11B LN FW MTCH used to enter the standard numbers for the second class required for an S_{11} 1-port calibration. (For default cal kits, this is the short.)

S11C LN FW TRAN used to enter the standard numbers for the third class required for an S_{11} 1-port calibration. (For default kits, this is the load.)

S22A RE RV MTCH used to enter the standard numbers for the first class required for an S_{22} 1-port calibration. (For default cal kits,

What is Measurement Calibration?

this is the open.)

S22B LN RV MTCH used to enter the standard numbers for the second class required for an S_{22} 1-port calibration. (For default cal kits, this is the short.)

S22C LN RV TRAN used to enter the standard numbers for the third class required for an S_{22} 1-port calibration. (For default kits, this is the load.)

Pressing the MORE softkey leads to the following softkeys:

FWD TRANS used to enter the standard numbers for the forward transmission thru calibration. (For default kits, this is the thru.)

REV TRANS used to enter the standard numbers for the reverse transmission (thru) calibration. (For default kits, this is the thru.)

FWD MATCH used to enter the standard numbers for the forward match (thru) calibration. (For default kits, this is the thru.)

REV MATCH used to enter the standard numbers for the reverse match (thru) calibration. (For default kits, this is the thru.)

RESPONSE used to enter the standard numbers for a response calibration. This calibration corrects for frequency response in either reflection or transmission measurements, depending on the parameter being measured when a calibration is performed. (For default kits, the standard is either the open or short for reflection measurements, or the thru for transmission measurements.)

RESPONSE & ISOL'N used to enter the standard numbers for a response & isolation calibration. This calibration corrects for frequency response and directivity in reflection measurements, or frequency response and isolation in transmission measurements.

Pressing the MORE softkey leads to the following softkeys:

TRL THRU used to enter the standard numbers for a TRL thru calibration.

TRL REFLECT used to enter the standard numbers for a TRL reflection calibration.

TRL LINE OR MATCH used to enter the standard numbers for a TRL line or match

calibration.

Label class menus The label class menus are used to define meaningful labels for the calibration classes. These then become softkey labels during a measurement calibration. Labels can be up to ten characters long.

Label kit menu After a new calibration kit has been defined, be sure to specify a label for it. Choose a label that describes the connector type of the calibration devices. This label will then appear in the *CAL KIT* softkey label in the correction menu and the *MODIFY* label in the select cal kit menu. It will be saved with calibration sets.

This menu is accessed with the *LABEL KIT* softkey in the modify cal kit menu, and is identical to the label class menu and the label standard menu described above. It allows definition of a label up to eight characters long.

Verify performance

Once a measurement calibration has been generated with a user-defined calibration kit, its performance should be checked before making device measurements. To check the accuracy that can be obtained using the new calibration kit, a device with a well-defined frequency response (preferably unlike any of the standards used) should be measured. The verification device must not be one of the calibration standards: measurement of one of these standards is merely a measure of repeatability.

To achieve more complete verification of a particular measurement calibration, accurately known verification standards with a diverse magnitude and phase response should be used. NIST traceable or Agilent Technologies standards are recommended to achieve verifiable measurement accuracy.

NOTE

The published specifications for the Agilent 8702E analyzer system include accuracy enhancement with compatible calibration kits. Measurement calibrations made with user-defined or modified calibration kits are not subject to the Agilent 8702E specifications, although a procedure similar to the system verification procedure may be used.

Using the front panel to examine or modify calibration

What is Measurement Calibration?**constants**

Calibration constants can be loaded into the analyzer's user-defined kit via front panel entry. Follow the procedure below to enter, modify, or examine standard definitions on the Agilent 8702E analyzer.

- 1** Press *CAL*, *CAL KIT & STDS*, *SELECT CAL KIT*, *MORE*. If necessary, press *MORE* to select the desired calibration kit.
- 2** Select the softkey that corresponds to the kit you want to modify or examine.
- 3** Press *RETURN*, *MODIFY CAL KIT*.
- 4** Press *DEFINE STANDARD* and use the front panel entry keys to enter the number of the standard you want to examine or modify. For example, to select a short press: 1, x1.
- 5** Press the underlined softkey. If you selected a short in the previous step, *SHORT* should be the underlined softkey.
- 6** This step applies only to the *open*. Go to the next step if you selected any other standard.

Press *C0*. Observe the value on the analyzer screen. To change the value, use the entry keys on the front panel. Repeat this step for *C1*, *C2*, and *C3*.

- 7** This step applies only to the *load*. Go to the next step if you selected any other standard.

Ensure that the correct load type is underlined: *FIXED* or *SLIDING*.

- 8** Press *SPECIFY OFFSET*.
- 9** Press *OFFSET DELAY* and observe the value on the analyzer screen. To change the value, use the entry keys on the front panel. Repeat this step for the softkeys listed below:
 - *OFFSET LOSS*
 - *OFFSET Z0*
 - *MINIMUM FREQUENCY*
 - *MAXIMUM FREQUENCY*
- 10** Ensure that the correct transmission line is underlined: *COAX* or *WAVEGUIDE*.
- 11** Press *STD OFFSET DONE*, *STD DONE (DEFINED)*.
- 12** Repeat [Step 4](#) through [Step 11](#) for the remaining standards.

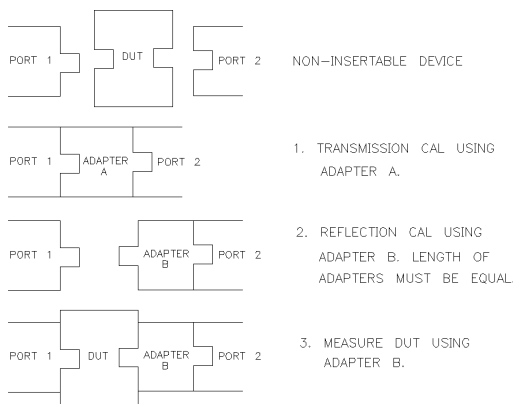
Saving the modified calibration constants

If you made modifications to any of the standard definitions, follow the remaining steps in this procedure to assign a kit label and store them in the non-volatile memory. The new set of standard definitions will be available under *USER KIT* until they are overwritten by another kit or become modified and saved.

- 13 Press *LABEL KIT, ERASE TITLE*. Use the front panel knob to move the pointer to a character and press *SELECT LETTER*.
- 14 Press *DONE, KIT DONE (DEFINED)*.
- 15 To save the standard definitions in the user-defined kit, press *SAVE USER KIT*.

Calibrating for non-insertable devices

A test device having the same sex connector on both the input and output cannot be connected directly into a transmission test configuration. Therefore, the device is considered to be *non-insertable*, and the following calibration method must be performed.



pg6136d

Figure 5-30. Calibrating for Non-Insertable Devices

With this method, you use two precision matched adapters which are “equal.” To be equal, the adapters must have the same match, Z_0 , insertion loss, and electrical delay.

To use this method, refer to [Figure 5-30](#) and perform the following steps:

What is Measurement Calibration?

- 1 Perform a transmission calibration using the first adapter.
- 2 Remove adapter A, and place adapter B on port 2. Adapter B becomes the effective test port.
- 3 Perform a reflection cal.
- 4 Measure the test device with adapter B in place.

The errors remaining after calibration with this method are equal to the differences between the two adapters that are used.

TRL*/LRM* calibration

The Agilent 8702E analyzer has the capability for making calibrations using the “TRL” (thru-reflect-line) method. This method is convenient in that calibration standards can be fabricated for a specific measurement environment, for example, a transistor test fixture or microstrip. This convenience allows for accurate measurements of chip packages, MMIC’s, RFIC’s, beam-lead devices, and so on.

For coaxial, waveguide and other environments where high-quality impedance standards are readily available, the traditional short, open, load, thru (SOLT) method still provides the most accurate results since all of the significant systematic errors are reduced. This method is implemented in the Agilent 8702E in the form of the S_{11} 1-port, S_{22} 1-port, and full 2-port calibration selections.

In all measurement environments, the user must provide calibration standards for the desired calibration to be performed. The advantage of TRL is that only three standards need to be characterized as opposed to 4 in the traditional open, short, load, and thru full 2-port calibrations. Further, the requirements for characterizing the T, R, and L standards are less stringent and these standards are more easily fabricated.

Notice that the letters TRL, LRL, LRM are often interchanged depending the standards used. For example, “LRL” indicates that two lines and a reflect standard are used; “TRM” indicates that a thru, reflection and match standards are used. All of these refer to the same basic method.

The TRL*/LRM* calibration used in the Agilent 8702E relies on the characteristic impedance of simple transmission lines rather than on a set of discrete impedance standards. Since transmission lines are relatively easy to fabricate (in a microstrip, for example), the impedance of these lines can be determined from the physical dimensions and substrate’s dielectric constant. For a fixture, TRL* can eliminate the effects of the fixture’s loss and length, but

does not completely remove the effects due to the mismatch of the fixture. (This is in contrast to the “pure” TRL technique used by the Agilent 8510 microwave network analyzers; see *Product Note 8510-8A*, literature number 5091-3645E. The Agilent 8510 hardware includes measurements made by an additional reference measurement port to completely correct for source and load match errors. Also, refer to *Product Note 8720-2*, literature number 5091-1943E for more detail on TRL* as implemented on the Agilent 8720C, which is basically the same as the Agilent 8702E implementation.)

Because the technique relies on the characteristic impedance of transmission lines, the mathematically equivalent method LRM* (for line-reflect-match) may be substituted for TRL*. Since a well matched termination is, in essence, an infinitely long transmission line, it is well suited for low (RF) frequency calibrations. Achieving a long line standard for low frequencies is oftentimes physically unrealizable, as will be demonstrated below.

Fabricating and defining calibration standards for TRL*/LRM*

When calibrating an analyzer, the actual calibration standards must have known physical characteristics. For the reflect standard, these characteristics include the offset in electrical delay (seconds) and the loss (ohms/second of delay). The characteristic impedance, *OFFSET Z0*, is not used in the calculations in that it is determined by the line standard. The reflection coefficient magnitude should optimally be 1.0, but need not be known since the same reflect standard must be applied to both ports.

The thru standard may be a zero-length or known length of transmission line. The value of length must be converted to electrical delay, just like that done for the reflect standard. The loss term must also be specified.

The line standard must meet specific frequency related criteria, in conjunction with the length used by the thru standard. In particular, the insertion phase of the line must not be the same as the thru. The optimal line length is 1/4 wavelength (90 degrees) relative to a zero length thru at the center frequency of interest, and between 20 and 160 degrees of phase difference over the frequency range of interest.

NOTE:

These phase values can be $\pm N \times 180$ degrees where N is an integer.

If two lines are used (LRL), the difference in electrical length of the two lines should meet these optimal conditions. Measurement uncertainty will increase significantly when the insertion phase nears zero an integer multiple of 180 degrees, and it is not recommended.

What is Measurement Calibration?

For a transmission media that exhibits linear phase over the frequency range of interest, the following expression can be used to determine a suitable line length of one-quarter wavelength at the center frequency (which equals the sum of the start frequency and stop frequency divided by 2):

$$\text{Electrical length (cm)} = (\text{LINE} - \text{zero length THRU})$$

$$\text{Electrical length (cm)} = (5000 \times \text{VF}) / [f_1 \text{ (MHz)} + f_2 \text{ (MHz)}]$$

let:

$$f_1 = 1000 \text{ MHz}$$

$$f_2 = 2000 \text{ MHz}$$

$$\text{VF} = \text{Velocity Factor} = 1 \text{ (for this example)}$$

Thus, the length to initially check is 5 cm

Next, use the following to verify the insertion phase at f_1 and f_2 :

$$\text{Phase (degrees)} = (360 \times f \times l) / v$$

where:

$$f = \text{frequency}$$

$$l = \text{length of line}$$

$$v = \text{velocity} = \text{speed of light} \times \text{velocity factor}$$

which can be reduced to the following using frequencies in MHz and length in centimeters:

$$\text{Phase (degrees) approx} = 0.012 \times f \text{ (MHz)} \times l \text{ (cm)} / \text{VF}$$

So for an air line (velocity factor approximately 1) at 1000 MHz, the insertion phase is 60 degrees for a 5 cm line; it is 120 degrees at 2000 MHz. This line would be a suitable line standard.

For microstrip and other fabricated standards, the velocity factor is significant. In those cases, the phase calculation must be divided by that factor. For example, if the dielectric constant for a substrate is 10, and the corresponding "effective" dielectric constant for microstrip is 6.5, then the "effective" velocity factor equals 0.39 ($1 \div \text{square root of } 6.5$).

Using the example frequencies and equation 1, the initial length to test is 1.95 cm. This length provides an insertion phase at 1000 MHz of 60 degrees; at 2000 MHz, 120 degrees (the insertion phase should be the same as the air line because the velocity factor was accounted for when using equation 1).

Another reason for showing this example is to point out the potential problem in calibrating at low frequencies using TRL*. For example, one-quarter wavelength (in vacuum) at 50 MHz is:

$$\text{Length} = 7500 \times VF / f_c$$

where:

f_c = center frequency

$$\text{Length} = 7500 / 50 \text{ MHz} = 150 \text{ cm or } 1.5 \text{ m}$$

Such a line standard would not only be difficult to fabricate, but its long term stability and usability would be questionable as well.

Thus at lower frequencies and/or broadband measurements, fabrication of a “match” or termination may be deemed more practical. Since a termination is, in essence, an infinitely long transmission line, it fits the TRL model mathematically, and is sometimes referred to as a “TRM” calibration.

For information on how to modify calibration constants for TRL*/LRM*, and how to perform a TRM* calibration, refer to the *Agilent 8702E User's Guide*.

Power meter calibration

An GPIB-compatible power meter can monitor and correct RF source power to achieve leveled power at the test port. To correct the power going to the test device, power meter calibration samples the power at each measurement point across the frequency band of interest. It then constructs a correction data table which the instrument uses to correct the power output of the internal source. The correction table may be saved in an instrument state register with the *SAVE* key.

The correction table may be updated on each sweep (in a leveling application) or during an initial single sweep. In the sample-and-sweep mode the power meter is not needed for subsequent sweeps. The correction table may be read or modified through GPIB.

Primary applications

- When you are testing a system with significant frequency response errors. For example, a coupler with significant roll-off, or a long cable with a significant amount of loss.
- When you are measuring devices that are very sensitive to actual input power

What is Measurement Calibration?

for proper operation.

- When you require a reference for receiver power calibration.

Calibrated power level

By setting the analyzer calibrated power to the desired value at the power meter, this power level will be maintained at that port during the entire sweep. First set the source power so that the power at the test device is approximately correct. This reduces residual power errors when only one reading is taken. When power meter calibration is on, the annotation **PC** is displayed. This indicates that the source power is being changed during the sweep. Calibrated power level becomes the active entry if any of the following softkeys are pressed:

```
PWRMTR CAL [OFF]
EACH SWEEP
ONE SWEEP
POWER (if power meter cal is on)
```

Regardless of the measurement application, the analyzer's source can only supply corrected power within the selected power range. If power outside this range is requested, the annotation will change to **PC?**.

Compatible sweep types

Power meter calibration may be used in linear, log, list, CW, and power sweep modes. In power sweep, the power at each point is the true power at the power meter, not the power at the analyzer's source output.

Loss of power meter calibration data

The power meter calibration data will be lost by committing any of the following actions:

Turning power off

Turning off the instrument erases the power meter calibration table.

Changing sweep type

If the sweep type is changed (linear, log, list, CW, power) while power meter calibration is on, the calibration data will be lost. However, calibration data is retained if you change the sweep type while power meter calibration is off.

Changing frequency

Power meter calibration data will also be lost if the frequency is changed in log or list mode, but it is retained in linear sweep mode.

Pressing PRESET.

Presetting the instrument will erase power meter calibration data. If the instrument state has been saved in a register using the SAVE/RECALL key, you may recall the instrument state and the data will be restored. Saving the instrument state will not protect the data if the instrument is turned off.

Interpolation in power meter calibration

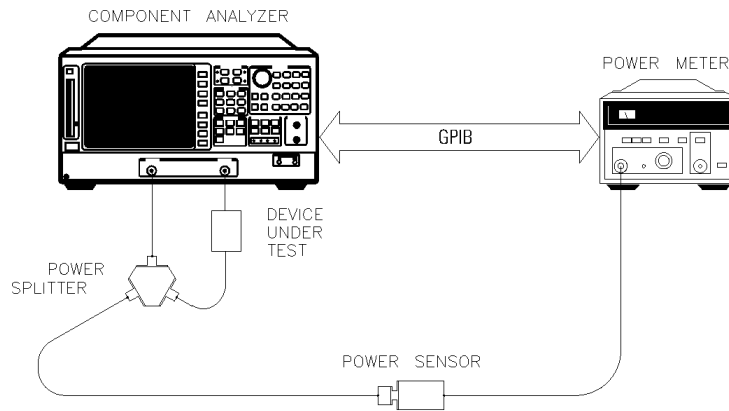
If the frequency is changed in linear sweep, or the start/stop power is changed in power sweep, then the calibration data is interpolated for the new range.

If calibration power is changed in any of the sweep types, the data array is increased or decreased to reflect the new power level. Some accuracy is lost when this occurs.

Power meter calibration modes of operation**Continuous sample mode**

You can set the analyzer to update the correction table at each sweep (as in a leveling application), using the continuous sample mode. In this mode, the analyzer checks the power level at every frequency point each time it sweeps. You can also have more than one sample/correction iteration at each frequency point.

While using the continuous sample mode, the power meter must remain connected as shown in [Figure 5-31](#). A power splitter or directional coupler samples the actual power going to the test device and is measured by the power meter. The power meter measurement provides the information necessary to update the correction table via GPIB.

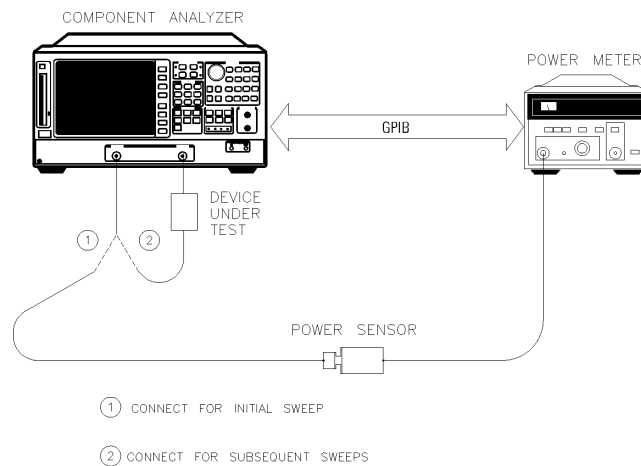
What is Measurement Calibration?

pg680d

Figure 5-31. Test Setup for Continuous Sample Mode

Continuous correction slows the sweep speed considerably, especially when low power levels are being measured by the power meter. It may take up to 10 seconds per point if the power level is less than -20 dBm. For faster operation, you can use the sample-and-sweep mode. If you use a directional coupler, you must enter the attenuation of the coupled arm with respect to the through arm using the *POWER LOSS* softkey.

Sample-and-sweep mode You can use the sample-and-sweep mode to correct the analyzer output power and update the power meter calibration data table during the initial measurement sweep. In this mode of operation, the analyzer does not require the power meter for subsequent sweeps. You may use a power splitter or directional coupler, or simply connect the power sensor directly to the analyzer to measure the power for the initial sweep prior to connecting and measuring the test device (refer to [Figure 5-32](#)).



pg698d

Figure 5-32. Test Setup for Sample-and-Sweep Mode

The speed of the calibration will be slow while power meter readings are taken (refer to [Table 5-5, “Typical Speed and Accuracy,”](#) on page 5-65). However, once the sample sweep is finished, subsequent sweeps are power-corrected using the data table, and sweep speed increases significantly. Once the initial sweep is taken, sample-and-sweep correction is much faster than continuous sample correction.

If the calibrated power level is changed after the initial measurement sweep is done, the entire correction table is increased or decreased by that amount and the annotation *PCO* appears on the display. The resulting power will no longer be as accurate as the original calibration.

Power loss correction list

If a directional coupler or power splitter is used to sample the RF power output of the analyzer, the RF signal going to the power meter may be different than that going to the test device. A directional coupler will attenuate the RF signal by its specified coupling factor. The difference in attenuation between the through arm and the coupled arm (coupling factor) must be entered using the loss/sensor list menu. Non-linearities in either the directional coupler or power splitter can be corrected in the same way.

Power loss information is entered in much the same way as limit line parameters. Up to 12 segments may be entered, each with a different attenuation value. The entered data will not be lost if the instrument’s power is cycled.

What is Measurement Calibration?**Power sensor calibration factor list**

Two power sensor calibration data lists can be created in the analyzer. The first list is primarily intended to maintain data for power sensors being used with standard 3 GHz analyzers. For Option 006 (6 GHz) analyzers, however, a second lists must be used to cover the frequency range. No single power sensor covers the entire frequency range of 300 kHz to 6 GHz, therefore the calibration data for two different power sensors must be available. The entered data will not be lost if the instrument's power is cycled.

Speed and accuracy

The speed and accuracy of a power meter calibration vary depending on the test setup and the measurement parameters. When the number of readings = 1, accuracy is improved if you set the source power such that it is approximately correct at the measurement port. Power meter calibration should then be turned on.

[Table 5-5](#) shows typical sweep speed and power accuracy. The times given apply only to the test setup for continuous correction or for the first sweep of sample-and-sweep correction.

The typical values given in [Table 5-5](#) were derived under the following conditions:

Test equipment used

- Agilent 8702E component analyzer
- Agilent 436A power meter
- Agilent 8482A power sensor

Stimulus parameters

The time required to perform a power meter calibration depends on the source power and number of points tested. The parameters used to derive the typical values in [Table 5-5](#) are as follows:

- number of points: 51, 100 kHz to 3 GHz
- test port power: equal to calibration power

Sweep time is linearly proportional to the number of points measured. For example, a sweep taking 49 seconds at 51 points will take approximately 98 seconds if 101 points are measured.

Table 5-5. Typical Speed and Accuracy

Power Desired at Test Port (dBm)	Number of Readings	Sweep Time (seconds) ^a	Typical Accuracy (dB)
+5	1	49	±0.2
	2	94	±0.1
	3	136	±0.1
-15	1	49	±0.2
	2	95	±0.2
	3	138	±0.1
-25	1	56	±0.4
	2	98	±0.3
	3	147	±0.25

a. Sweep speed applies to every sweep in continuous correction mode, and to the first sweep in sample-and-sweep mode. Subsequent sweeps in sample-and-sweep mode will be much faster.

Notes on accuracy

The accuracy values in [Table 5-5](#) were derived by combining the accuracy of the power meter and linearity of the analyzer’s internal source, as well as the mismatch uncertainty associated with the test set and the power sensor.

Power meter calibration measures the source power output (at the measurement port) at a single stimulus point, and compares it to the calibrated power you selected. If the two values are different, power meter calibration changes the source output power by the difference. This process is repeated at every stimulus point. The accuracy of the result depends on the amount of correction required. If the selected number of readings = 1, the final measurement accuracy is significantly affected by a large power change. However, if the selected number of readings is >1, the power change on the second or third reading is much smaller: thus accuracy is much better.

The following methods can be used to perform power meter calibration. If the selected number of readings is >1, then it makes little difference which method is used. However, if number of readings = 1, then the first method provides better accuracy. The values in [Table 5-5](#) were derived using the second (worst case) method.

- Set source power approximately correct at the measurement port, then activate power meter calibration. This method can significantly increase the accuracy of the measurement when the selected number of readings = 1. Smaller accuracy improvements occur with a higher number of readings. Remember

What is Measurement Calibration?

that mismatch errors affect accuracy as well.

- Activate power meter calibration independent of the source's current power setting. There may be a large difference between the current power level and the desired calibrated power level. Power meter calibration will automatically adjust the power at the measurement port to match the desired calibrated power level. However, a large change in power affects accuracy, especially if the number of readings = 1.

NOTE

Power meter correction applies to one port only; the other port is not corrected.

Understanding and Using Time Domain

The analyzer can transform frequency domain data to the time domain or time domain data to the frequency domain.

In normal operation, the analyzer measures the characteristics of a test device as a function of frequency. Using a mathematical technique (the inverse Fourier transform), the analyzer transforms frequency domain information into the time domain, with time as the horizontal display axis. Response values (measured on the vertical axis) now appear separated in time or distance, providing valuable insight into the behavior of the test device beyond simple frequency characteristics.

The transform used by the analyzer resembles time domain reflectometry (TDR) measurements. TDR measurements, however, are made by launching an impulse or step into the test device and observing the response in time with a receiver similar to an oscilloscope. In contrast, the analyzer makes swept frequency response measurements, and mathematically transforms the data into a TDR-like display.

The analyzer has three frequency-to-time transform modes:

- Time domain bandpass mode is designed to measure band-limited devices and is the easiest mode to use. This mode simulates the time domain response to an impulse input.
- Time domain low pass step mode simulates the time domain response to a step input. As in a traditional TDR measurement, the distance to the discontinuity in the test device, and the type of discontinuity (resistive, capacitive, inductive) can be determined.
- Time domain low pass impulse mode simulates the time domain response to an impulse input (like the bandpass mode). Both low pass modes yield better time domain resolution for a given frequency span than does the bandpass mode. In addition, using the low pass modes you can determine the type of discontinuity. However, these modes have certain limitations that are defined in [“Time domain low pass” on page 5-73](#).

The analyzer has one time-to-frequency transform mode:

- Forward transform mode transforms CW signals measured over time into the

frequency domain, to measure the spectral content of a signal. This mode is known as the CW time mode.

In addition to these transform modes, this section discusses special transform concepts such as masking, windowing, and gating.

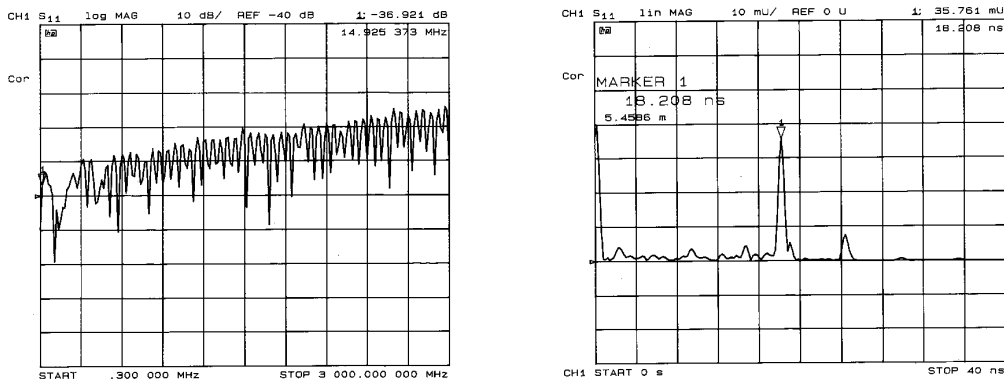
General theory

The relationship between the frequency domain response and the time domain response of the analyzer is defined by the Fourier transform. Because of this transform, it is possible to measure, in the frequency domain, the response of a linear test device and mathematically calculate the inverse Fourier transform of the data to find the time domain response. The analyzer's internal computer makes this calculation using the chirp-Z Fourier transform technique. The resulting measurement is the fully error-corrected time domain reflection or transmission response of the test device, displayed in near real-time.

[Figure 5-33](#) illustrates the frequency and time domain reflection responses of a test device. The frequency domain reflection measurement is the composite of all the signals reflected by the discontinuities present in the test device over the measured frequency range.

NOTE

In this section, all points of reflection are referred to as discontinuities.



(a) Frequency Domain

(b) Time Domain Bandpass

pg6198_c

Figure 5-33. Device Frequency Domain and Time Domain Reflection Responses

The time domain measurement shows the effect of each discontinuity as a function of time (or distance), and shows that the test device response consists of three separate impedance changes. The second discontinuity has a reflection coefficient magnitude of 0.035 (or, 3.5% of the incident signal is reflected). Marker 1 on the time domain trace shows the elapsed time to the discontinuity and back to the reference plane (where the calibration standards are connected): 18.2 nanoseconds. The distance shown (5.45 meters) is based on the assumption that the signal travels at the speed of light. The signal travels slower than the speed of light in most media (for example, coax cables). This slower velocity (relative to light) can be compensated for by adjusting the analyzer relative velocity factor. This procedure is described in [“Time domain bandpass” on page 5-69](#).

Time domain bandpass

This mode is called bandpass because it works with band-limited devices. Traditional TDR requires that the test device be able to operate down to dc. Using bandpass mode, there are no restrictions on the measurement frequency range. Bandpass mode characterizes the test device impulse response.

Understanding and Using Time Domain

Adjusting the relative velocity factor

A marker provides both the time ($x2$) and the electrical length ($x2$) to a discontinuity. To determine the physical length, rather than the electrical length, change the velocity factor to that of the medium under test:

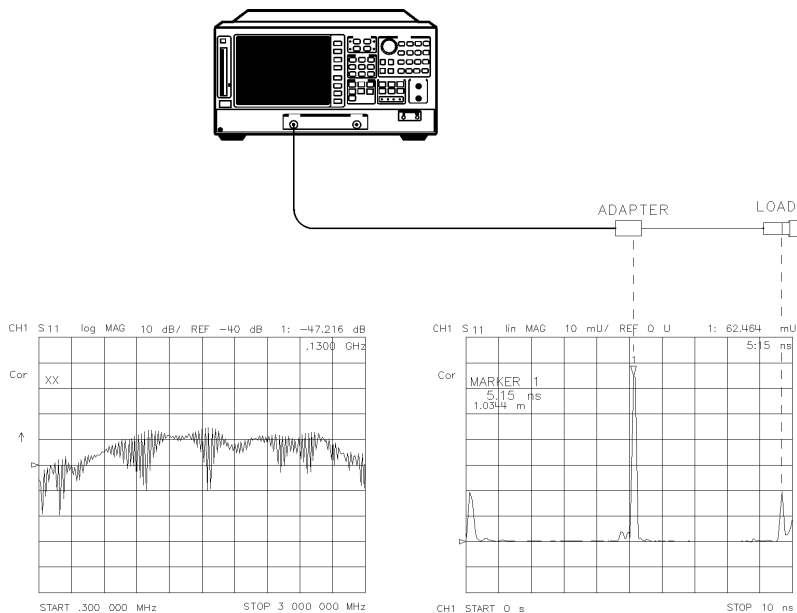
- 1 Press **CAL**, **MORE**, **VELOCITY FACTOR**.
- 2 Enter a velocity factor between 0 and 1.0 (1.0 corresponds to the speed of light in a vacuum). Most cables have a velocity factor of 0.66 (polyethylene dielectrics) or 0.70 (teflon dielectrics).

NOTE

To cause the markers to read the actual one-way distance to a discontinuity, rather than the two-way distance, enter one-half the actual velocity factor.

Reflection measurements using bandpass mode

The bandpass mode can transform reflection measurements to the time domain. [Figure 5-34a](#) shows a typical frequency response reflection measurement of two sections of cable. [Figure 5-34b](#) shows the same two sections of cable in the time domain using the bandpass mode.



pg612

Figure 5-34. A Reflection Measurement of Two Cables

The ripples in reflection coefficient versus frequency in the frequency domain measurement are caused by the reflections at each connector “beating” against each other.

One at a time, loosen the connectors at each end of the cable and observe the response in both the frequency domain and the time domain. The frequency domain ripples increase as each connector is loosened, corresponding to a larger reflection adding in and out of phase with the other reflections. The time domain responses increase as you loosen the connector that corresponds to each response.

Interpreting the bandpass reflection response horizontal axis

In bandpass reflection measurements, the horizontal axis represents the time it takes for an impulse launched at the test port to reach a discontinuity and return to the test port (the two-way travel time). In [Figure 5-34](#), each connector is a discontinuity.

Understanding and Using Time Domain

Interpreting the bandpass reflection response vertical axis

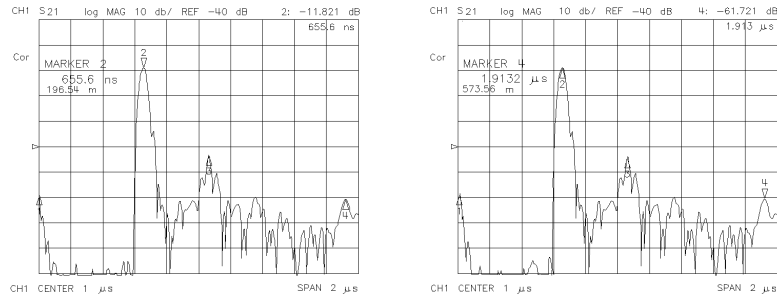
The quantity displayed on the vertical axis depends on the selected format. The common formats are listed in Table 5-6. The default format is LOG MAG (logarithmic magnitude), which displays the return loss in decibels (dB). LIN MAG (linear magnitude) is a format that displays the response as reflection coefficient (ρ). This can be thought of as an average reflection coefficient of the discontinuity over the frequency range of the measurement. Use the REAL format only in low pass mode.

Table 5-6. Time Domain Reflection Formats

Format	Parameter
LIN MAG	Reflection Coefficient (unitless) ($0 < \rho < 1$)
REAL	Reflection Coefficient (unitless) ($-1 < \rho < 1$)
LOG MAG	Return Loss (dB)
SWR	Standing Wave Ratio (unitless)

Transmission measurements using bandpass mode

The bandpass mode can also transform transmission measurements to the time domain. For example, this mode can provide information about a surface acoustic wave (SAW) filter that is not apparent in the frequency domain. Figure 5-35 illustrates a time domain bandpass measurement of a 321 MHz SAW filter.



pg678.

Figure 5-35. Transmission Measurement in Time Domain Bandpass Mode

Interpreting the bandpass transmission response horizontal axis

In time domain transmission measurements, the horizontal axis is displayed in units of time. The time axis indicates the propagation delay through the device. Note that in time domain transmission measurements, the value displayed is the actual delay (not $\times 2$). The marker provides the propagation delay in both time and distance.

Marker 2 in [Figure 5-35a](#) indicates the main path response through the test device, which has a propagation delay of 655.6 ns, or about 196.5 meters in electrical length. Marker 4 in [Figure 5-35b](#) indicates the triple-travel path response at 1.91 μ s, or about 573.5 meters. The response at marker 1 (at 0 seconds) is an RF feedthru leakage path. In addition to the triple travel path response, there are several other multi-path responses through the test device, which are inherent in the design of a SAW filter.

Interpreting the bandpass transmission response vertical axis

In the log magnitude format, the vertical axis displays the transmission loss or gain in dB; in the linear magnitude format it displays the transmission coefficient (τ). Think of this as an average of the transmission response over the measurement frequency range.

Time domain low pass

This mode is used to simulate a traditional time domain reflectometry (TDR) measurement. It provides information to determine the type of discontinuity (resistive, capacitive, or inductive) that is present. Low pass provides the best resolution for a given bandwidth in the frequency domain. It may be used to give either the step or impulse response of the test device.

The low pass mode is less general-purpose than the bandpass mode because it places strict limitations on the measurement frequency range. The low pass mode requires that the frequency domain data points are harmonically related from dc to the stop frequency. That is, $stop = n \times start$, where n = number of points. For example, with a start frequency of 300 kHz and 101 points, the stop frequency would be 30.3 MHz. Since the analyzer frequency range starts at 300 kHz, the dc frequency response is extrapolated from the lower frequency data. The requirement to pass dc is the same limitation that exists for traditional TDR.

Setting frequency range for time domain low pass

Before a low pass measurement is made, the measurement frequency range must meet the ($stop = n \times start$) requirement described above. The *SET FREQ LOW PASS* softkey performs this function automatically: the stop frequency is set close to the entered stop frequency, and the start frequency is set equal to stop/n.

If the low end of the measurement frequency range is critical, it is best to calculate approximate values for the start and stop frequencies before pressing *SET FREQ LOW PASS* and calibrating. This avoids distortion of the measurement results. To see an example, select the preset values of 201 points and a 300 kHz to 3 GHz frequency range. Now press *SET FREQ LOW PASS* and observe the change in frequency values. The stop frequency changes to 2.999 GHz, and the start frequency changes to 14.925 MHz. This would cause a distortion of measurement results for frequencies from 300 kHz to 14.925 MHz.

NOTE

If the start and stop frequencies do not conform to the low pass requirement before a low pass mode (step or impulse) is selected and transform is turned on, the analyzer resets the start and stop frequencies. If error correction is on when the frequency range is changed, this turns it off.

Minimum allowable stop frequencies

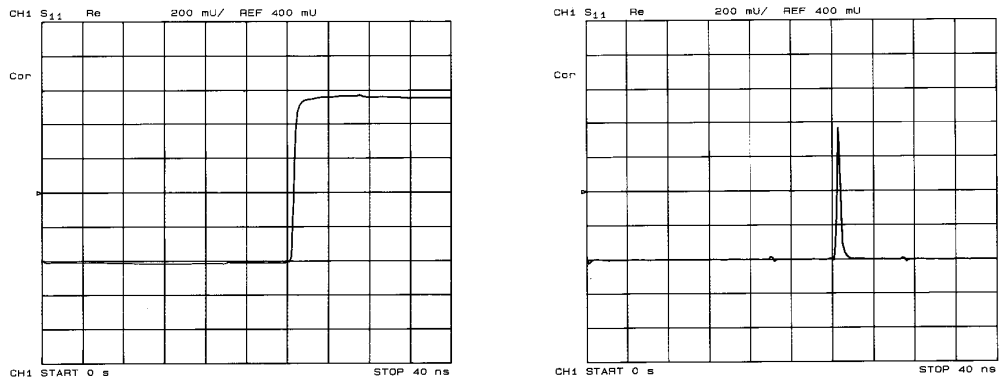
The lowest analyzer measurement frequency is 30 kHz, therefore for each value of n there is a minimum allowable stop frequency that can be used. That is, the *minimum stop frequency = $n \times 30$ kHz*. [Table 5-7](#) lists the minimum frequency range that can be used for each value of n for low pass time domain measurements.

Table 5-7. Minimum Frequency Ranges for Time Domain Low Pass

Number of Points	Minimum Frequency Range
3	30 kHz to 0.09 MHz
11	30 kHz to 0.33 MHz
26	30 kHz to 0.78 MHz
51	30 kHz to 1.53 MHz
101	30 kHz to 3.03 MHz
201	30 kHz to 6.03 MHz
401	30 kHz to 12.03 MHz
801	30 kHz to 24.03 MHz
1601	30 kHz to 48.03 MHz

Reflection measurements in time domain low pass

Figure 5-36 shows the time domain response of an unterminated cable in both the low-pass step and low-pass impulse modes.



pg6197_c

Figure 5-36. Time Domain Low Pass Measurements of an Unterminated Cable

Interpreting the low pass response horizontal axis

The low pass measurement horizontal axis is the two-way travel time to the discontinuity (as in the bandpass mode). The marker displays both the two-way time and the electrical length along the trace. To determine the actual physical length, enter the appropriate velocity factor as described in [“Time domain bandpass” on page 5-69](#).

Interpreting the low pass response vertical axis

The vertical axis depends on the chosen format. In the low pass mode, the frequency domain data is taken at harmonically related frequencies and extrapolated to dc. Because this results in the inverse Fourier transform having only a real part (the imaginary part is zero), the most useful low pass step mode format in this application is the real format. It displays the response in reflection coefficient units. This mode is similar to the traditional TDR response, which displays the reflected signal in a real format (volts) versus time (or distance) on the horizontal axis.

The real format can also be used in the low pass impulse mode, but for the best dynamic range for simultaneously viewing large and small discontinuities, use the log magnitude format.

Fault location measurements using low pass

As described, the low pass mode can simulate the TDR response of the test device. This response contains information useful in determining the type of discontinuity present.

[Figure 5-37](#) illustrates the low pass responses of known discontinuities. Each circuit element was simulated to show the corresponding low pass time domain S_{11} response waveform. The low pass mode gives the test device response either to a step or to an impulse stimulus. Mathematically, the low pass impulse stimulus is the derivative of the step stimulus.

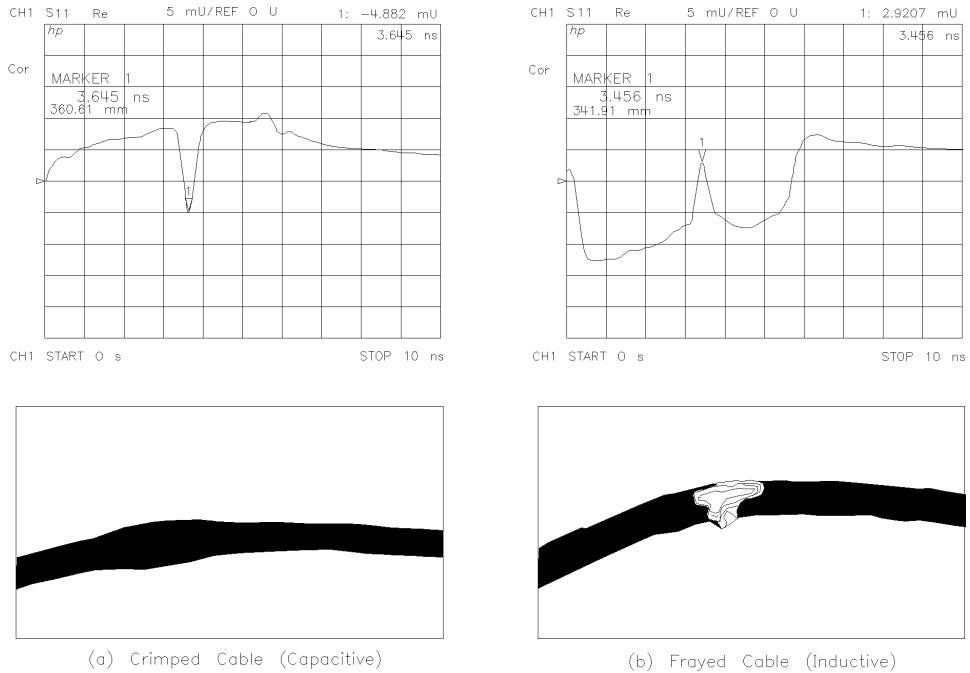
ELEMENT	STEP RESPONSE	IMPULSE RESPONSE
OPEN	 UNITY REFLECTION	 UNITY REFLECTION
SHORT	 UNITY REFLECTION, -180°	 UNITY REFLECTION, -180°
RESISTOR $R > Z_0$	 POSITIVE LEVEL SHIFT	 POSITIVE PEAK
RESISTOR $R < Z_0$	 NEGATIVE LEVEL SHIFT	 NEGATIVE PEAK
INDUCTOR	 POSITIVE PEAK	 POSITIVE THEN NEGATIVE PEAKS
CAPACITOR	 NEGATIVE PEAK	 NEGATIVE THEN POSITIVE PEAKS

pg6127d

Figure 5-37. Simulated Low Pass Step and Impulse Response Waveforms (Real Format)

Figure 5-38 shows example cables with discontinuities (faults) using the low pass step mode with the real format.

Concepts
Understanding and Using Time Domain



pg6123d

Figure 5-38. Low Pass Step Measurements of Common Cable Faults (Real Format)

Transmission measurements in time domain low pass

Measuring small signal transient response using low pass step

Use the low pass mode to analyze the test device's small signal transient response. The transmission response of a device to a step input is often measured at lower frequencies, using a function generator (to provide the step to the test device) and a sampling oscilloscope (to analyze the test device output response). The low pass step mode extends the frequency range of this type of measurement to 3 GHz (6 GHz with an analyzer Option 006).

The step input shown in [Figure 5-39](#) is the inverse Fourier transform of the frequency domain response of a thru measured at calibration. The step rise time is proportional to the highest frequency in the frequency domain sweep; the higher the frequency, the faster the rise time. The frequency sweep in [Figure 5-39](#) is from 10 MHz to 1 GHz.

Figure 5-39 also illustrates the time domain low pass response of an amplifier under test. The average group delay over the measurement frequency range is the difference in time between the step and the amplifier response. This time domain response simulates an oscilloscope measurement of the amplifier's small signal transient response. Note the ringing in the amplifier response that indicates an under-damped design.

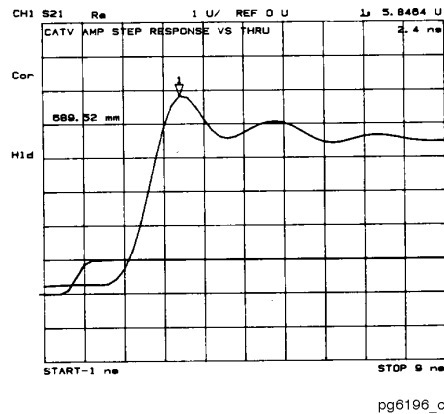


Figure 5-39. Time Domain Low Pass Measurement of an Amplifier Small Signal Transient Response

Interpreting the low pass step transmission response horizontal axis

The low pass transmission measurement horizontal axis displays the average transit time through the test device over the frequency range used in the measurement. The response of the thru connection used in the calibration is a step that reaches 50% unit height at approximately time = 0. The rise time is determined by the highest frequency used in the frequency domain measurement. The step is a unit high step, which indicates no loss for the thru calibration. When a device is inserted, the time axis indicates the propagation delay or electrical length of the device. The markers read the electrical delay in both time and distance. The distance can be scaled by an appropriate velocity factor as described in “Time domain bandpass” on page 5-69.

Understanding and Using Time Domain

Interpreting the low pass step transmission response vertical axis

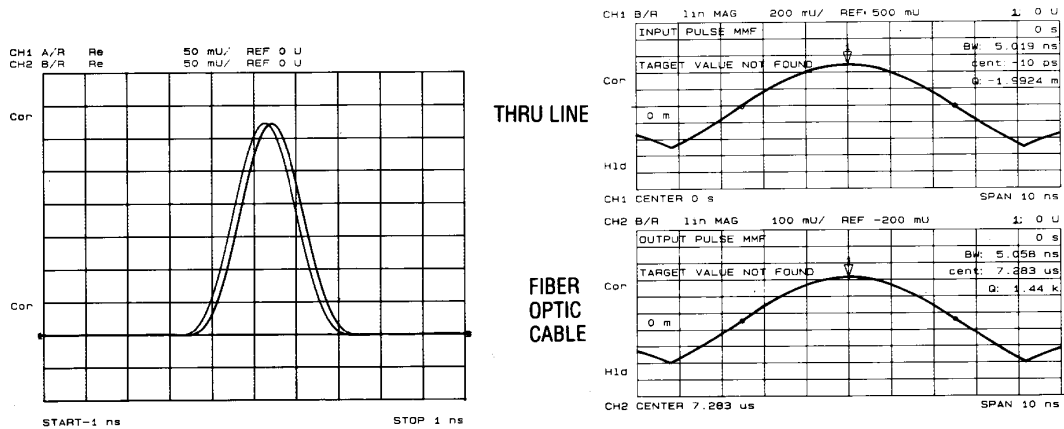
In the real format, the vertical axis displays the transmission response in real units (for example, volts). For the amplifier example in Figure 5-39, if the amplifier input is a step of 1 volt, the output, 2.4 nanoseconds after the step (indicated by marker 1), is 5.84 volts.

In the log magnitude format, the amplifier gain is the steady state value displayed after the initial transients die out.

Measuring separate transmission paths through the test device using low pass impulse mode

The low pass impulse mode can be used to identify different transmission paths through a test device that has a response at frequencies down to dc (or at least has a predictable response, above the noise floor, below 30 kHz). For example, use the low pass impulse mode to measure the relative transmission times through a multi-path device or to measure the pulse dispersion through a broadband transmission line, such as a fiber optic cable.

Both examples are illustrated in Figure 5-40. The horizontal and vertical axes can be interpreted as already described in this section under “Time domain bandpass” on page 5-69.



(a) Comparing Transmission Paths through a Power Divider

(b) Measuring Pulse Dispersion on a 1.5 km Fiber Optic Cable

pg6195_c

Figure 5-40. Transmission Measurements Using Low Pass Impulse Mode

Time domain concepts

Masking

Masking occurs when a discontinuity (fault) closest to the reference plane affects the response of each subsequent discontinuity. This happens because the energy reflected from the first discontinuity never reaches subsequent discontinuities. For example, if a transmission line has two discontinuities that each reflect 50% of the incident voltage, the time domain response (real format) shows the correct reflection coefficient for the first discontinuity ($\rho=0.50$). However, the second discontinuity appears as a 25% reflection ($\rho=0.25$) because only half the incident voltage reached the second discontinuity.

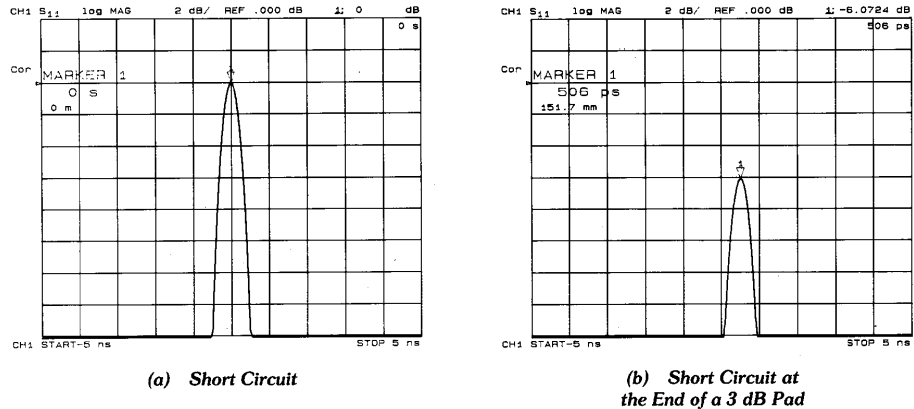
NOTE

This example assumes a loss-less transmission line. Real transmission lines, with non-zero loss, attenuate signals as a function of the distance from the reference plane.

As an example of masking due to line loss, consider the time domain response of a 3 dB attenuator and a short circuit. The impulse response (log magnitude format) of the short circuit alone is a return loss of 0 dB, as shown in [Figure 5-41a](#).

When the short circuit is placed at the end of the 3 dB attenuator, the return loss is -6 dB, as shown in [Figure 5-41b](#). This value actually represents the forward and return path loss through the attenuator, and illustrates how a lossy network can affect the responses that follow it.

Concepts
Understanding and Using Time Domain



pg6194_c

Figure 5-41. Masking Example

Windowing

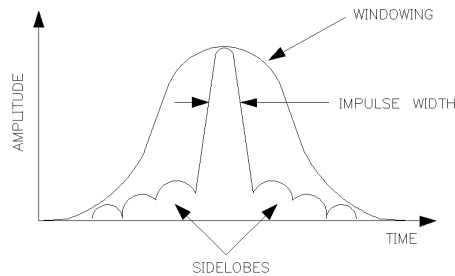
The analyzer provides a windowing feature that makes time domain measurements more useful for isolating and identifying individual responses. Windowing is needed because of the abrupt transitions in a frequency domain measurement at the start and stop frequencies. The band limiting of a frequency domain response causes overshoot and ringing in the time domain response, and causes a non-windowed impulse stimulus to have a $\text{sin}(kt)/kt$ shape, where: $k = \pi/\text{frequency span}$ and $t = \text{time}$ (refer to Figure 5-42). This has two effects that limit the usefulness of the time domain measurement:

Finite impulse width (or rise time)

Finite impulse width limits the ability to resolve between two closely spaced responses. The effects of the finite impulse width cannot be improved without increasing the frequency span of the measurement (refer to Table 5-8).

Sidelobes

The impulse sidelobes limit the dynamic range of the time domain measurement by hiding low-level responses within the sidelobes of higher level responses. The effects of sidelobes can be improved by windowing (refer to Table 5-8).



pg665d

Figure 5-42. Impulse Width, Sidelobes, and Windowing

Windowing improves the dynamic range of a time domain measurement by filtering the frequency domain data prior to converting it to the time domain, producing an impulse stimulus that has lower sidelobes. This makes it much easier to see time domain responses that are very different in magnitude. The sidelobe reduction is achieved, however, at the expense of increased impulse width. The effect of windowing on the step stimulus (low pass mode only) is a reduction of overshoot and ringing at the expense of increased rise time.

To select a window, press `SYSTEM`, `TRANSFORM MENU`, `WINDOW`. A menu is presented that allows the selection of three window types (refer to [Table 5-8](#)).

Table 5-8. Impulse Width, Sidelobe Level, and Windowing Values

Window Type	Impulse Sidelobe Level	Low Pass Impulse Width (50%)	Step Sidelobe Level	Step Rise Time (10 – 90%)
Minimum	-13 dB	0.60/Freq Span	-21 dB	0.45/Freq Span
Normal	-44 dB	0.98/Freq Span	-60 dB	0.99/Freq Span
Maximum	-75 dB	1.39/Freq Span	-70 dB	1.48/Freq Span

NOTE

The bandpass mode simulates an impulse stimulus. Bandpass impulse width is twice that of low pass impulse width. The bandpass impulse sidelobe levels are the same as low pass impulse sidelobe levels.

Understanding and Using Time Domain

Choose one of the three window shapes listed in [Table 5-8](#). Or you can use the knob to select any windowing pulse width (or rise time for a step stimulus) between the softkey values. The time domain stimulus sidelobe levels depend only on the window selected.

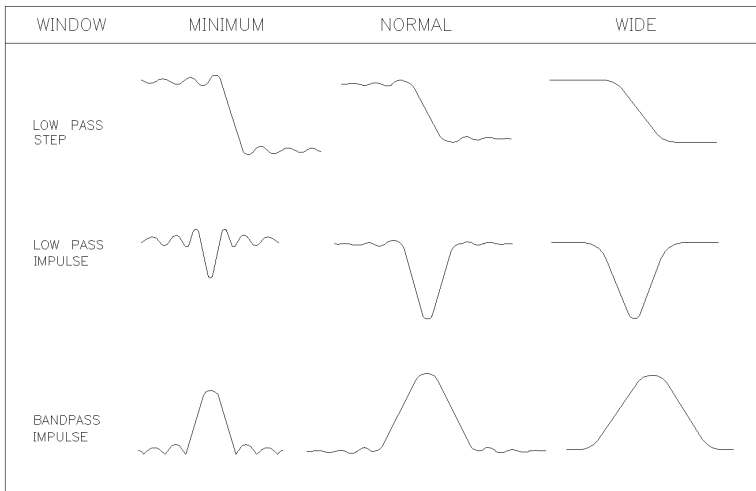
MINIMUM is essentially no window. Consequently, it gives the highest sidelobes.

NORMAL (the preset mode) gives reduced sidelobes and is the mode most often used.

MAXIMUM window gives the minimum sidelobes, providing the greatest dynamic range.

USE MEMORY on OFF remembers a user-specified window pulse width (or step rise time) different from the standard window values.

A window is activated only for viewing a time domain response, and does not affect a displayed frequency domain response. [Figure 5-43](#) shows the typical effects of windowing on the time domain response of a short circuit reflection measurement.



pg666d

Figure 5-43. The Effects of Windowing on the Time Domain Responses of a Short Circuit

Range

In the time domain, range is defined as the length in time that a measurement can be made without encountering a repetition of the response, called aliasing. A time domain response repeats at regular intervals because the frequency domain data is taken at discrete frequency points, rather than continuously over the frequency band.

Measurement range is equal to $1/\Delta F$ (ΔF is the spacing between frequency data points).

Measurement range = (number of points – 1)/frequency span (Hz).

Example:

Measurement	= 201 points 1 MHz to 2.001 GHz
Range = $1/\Delta F$ or (number of points – 1)/frequency span	= $1/(10 \times 10^6)$ or $(201 - 1)/(2 \times 10^9)$ = 100×10^{-9} seconds
Electrical length	= range x the speed of light (3×10^8 m/s) = $(100 \times 10^{-9} \text{ s}) \times (3 \times 10^8 \text{ m/s})$ = 30 meters

In this example, the range is 100 ns, or 30 meters electrical length. To prevent the time domain responses from overlapping, the test device must be 30 meters or less in electrical length for a transmission measurement (15 meters for a reflection measurement). The analyzer limits the stop time to prevent the display of aliased responses.

To increase the time domain measurement range, first increase the number of points, but remember that as the number of points increases, the sweep speed decreases. Decreasing the frequency span also increases range, but reduces resolution.

Resolution

Two different resolution terms are used in the time domain:

- Response resolution
- Range resolution

Response resolution

Time domain response resolution is defined as the ability to resolve two closely-spaced responses, or a measure of how close two responses can be to each other and still be distinguished from each other. For responses of equal amplitude, the response resolution is equal to the 50% (–6 dB) impulse width. It is inversely proportional to the measurement frequency span, and is also a function of the window used in the transform. The approximate formulas for calculating the 50% impulse width are given in [Table 5-8 on page 5-83](#). For example, using the formula for the bandpass mode with a normal windowing function for a 1 MHz to 3.001 GHz measurement (3 GHz span):

Understanding and Using Time Domain

$$\begin{aligned} 50\% \text{ calculated impulse width} &= 0.98 \times (1/3 \text{ GHz}) \times 2 \\ &= 0.65 \text{ nanoseconds} \\ \text{Electrical length (in air)} &= (0.65 \times 10^{-9} \text{ s}) \times (30 \times 10^9 \text{ cm/s}) \\ &= 19.6 \text{ centimeters} \end{aligned}$$

With this measurement, two equal responses can be distinguished when they are separated by at least 19.6 centimeters. In a 6 GHz measurement with an Option 006 analyzer, two equal responses can be distinguished when they are separated by at least 9.8 cm. Using the low pass mode (the low pass frequencies are slightly different) with a minimum windowing function, you can distinguish two equal responses that are about 5 centimeters or more apart.

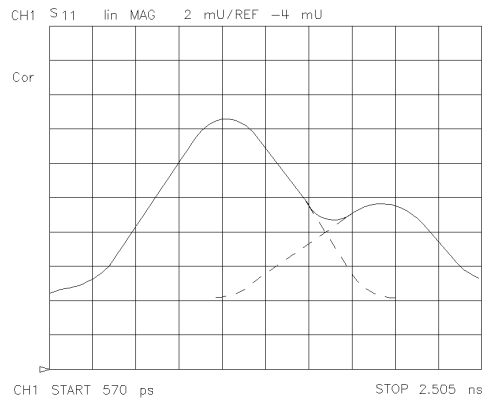
For reflection measurements, which measure the two-way time to the response, divide the response resolution by 2. Using the example above, you can distinguish two faults of equal magnitude provided they are 2.5 centimeters (electrical length) or more apart.

NOTE

Remember, to determine the physical length, enter the relative velocity factor of the transmission medium under test.

For example, a cable with a teflon dielectric (0.7 relative velocity factor), measured under the conditions stated above, has a fault location measurement response resolution of 1.7 centimeters. This is the maximum fault location response resolution. Factors such as reduced frequency span, greater frequency domain data windowing, and a large discontinuity shadowing the response of a smaller discontinuity, all act to degrade the effective response resolution.

[Figure 5-44](#) illustrates the effects of response resolution. The solid line shows the actual reflection measurement of two approximately equal discontinuities (the input and output of an SMA barrel). The dashed line shows the approximate effect of each discontinuity, if they could be measured separately.



pg682d

Figure 5-44. Response Resolution

While increasing the frequency span increases the response resolution, keep the following points in mind:

- The time domain response noise floor is directly related to the frequency domain data noise floor. Because of this, if the frequency domain data points are taken at or below the measurement noise floor, the time domain measurement noise floor is degraded.
- The time domain measurement is an average of the response over the frequency range of the measurement. If the frequency domain data is measured out-of-band, the time domain measurement is also the out-of-band response.

You may (with these limitations in mind) choose to use a frequency span that is wider than the test device bandwidth to achieve better resolution.

Range resolution

Time domain range resolution is defined as the ability to locate a single response in time. If only one response is present, range resolution is a measure of how closely you can pinpoint the peak of that response. The range resolution is equal to the digital resolution of the display, which is the time domain span divided by the number of points on the display. To get the maximum range resolution, center the response on the display and reduce the time domain span. The range resolution is always much finer than the response resolution (refer to [Figure 5-45](#)).

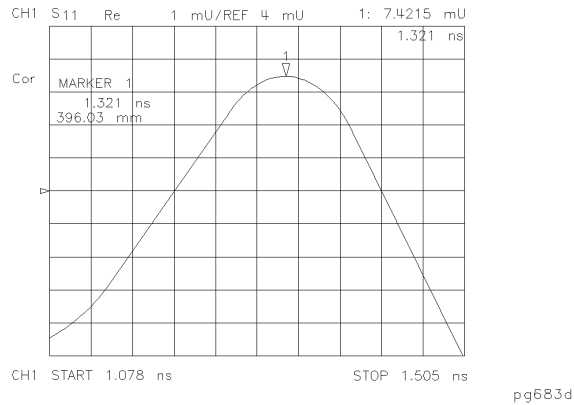


Figure 5-45. Range Resolution of a Single Discontinuity

The Transform Parameter feature can be used to view the current values of the range, response resolution and range resolution by pressing SYSTEM, TRANSFORM MENU, TRANSFORM PARAMETERS.

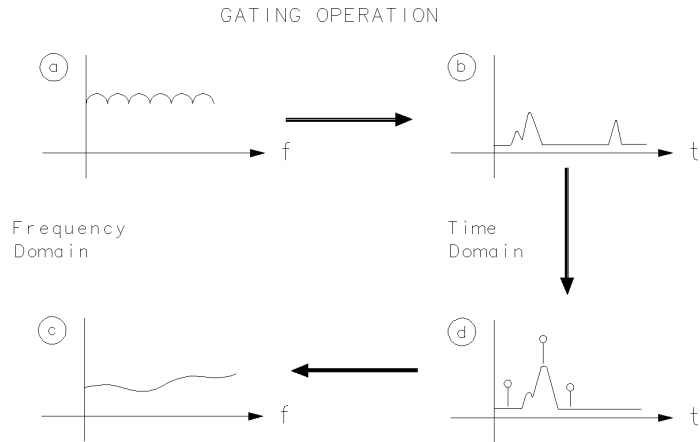
Gating

Gating provides the flexibility of selectively removing time domain responses. The remaining time domain responses can then be transformed back to the frequency domain. For reflection (or fault location) measurements, use this feature to remove the effects of unwanted discontinuities in the time domain. You can then view the frequency response of the remaining discontinuities. In a transmission measurement, you can remove the effects of multiple transmission paths.

Figure 5-46a shows the frequency response of an electrical airline and termination. Figure 5-46b shows the response in the time domain. The discontinuity on the left is due to the input connector. The discontinuity on the right is due to the termination. We want to remove the effect of the connector so that we can see the frequency response of just the airline and termination.

Figure 5-46c shows the gate applied to the connector discontinuity.

Figure 5-46d shows the frequency response of the airline and termination, with the connector “gated out.”



pgf

Figure 5-46. Sequence of Steps in Gating Operation

Setting the gate

Think of a gate as a bandpass filter in the time domain (refer to [Figure 5-47](#)). When the gate is on, responses outside the gate are mathematically removed from the time domain trace. Enter the gate position as a start and stop time (not frequency) or as a center and span time. The start and stop times are the bandpass filter -6 dB cutoff times. Gates can have a negative span, in which case the responses inside the gate are mathematically removed. The gate's start and stop flags define the region where gating is *on*.

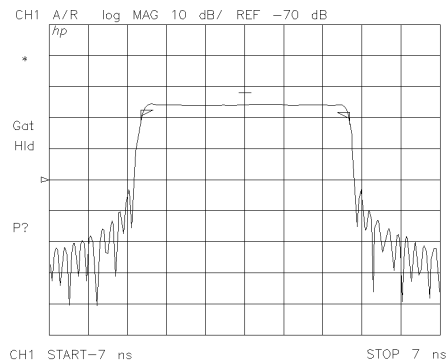


Figure 5-47. Gate Shape

Selecting gate shape

The four gate shapes available are listed in [Table 5-9](#). Each gate has a different passband flatness, cutoff rate, and sidelobe levels.

Table 5-9. Gate Characteristics

Gate Shape	Passband Ripple	Sidelobe Levels	Cutoff Time	Minimum Gate Span
Gate Span Minimum	±0.10 dB	-48 dB	1.4/Freq Span	2.8/Freq Span
Normal	±0.01 dB	-68 dB	2.8/Freq Span	5.6/Freq Span
Wide	±0.01 dB	-57 dB	4.4/Freq Span	8.8/Freq Span
Maximum	±0.01 dB	-70 dB	12.7/Freq Span	25.4/Freq Span

The passband ripple and sidelobe levels are descriptive of the gate shape. The cutoff time is the time between the stop time (-6 dB on the filter skirt) and the peak of the first sidelobe, and is equal on the left and right side skirts of the filter. Because the minimum gate span has no passband, it is just twice the cutoff time. Always choose a gate span wider than the minimum. For most applications, do not be concerned about the minimum gate span, simply use the knob to position the gate markers around the desired portion of the time domain trace.

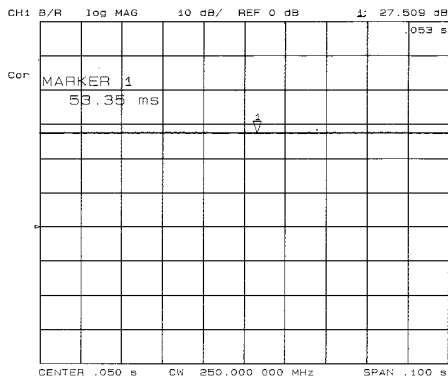
Transforming CW time measurements into the frequency domain

The analyzer can display the amplitude and phase of CW signals versus time. For example, use this mode for measurements such as amplifier gain as a function of warm-up time (for example, drift). The analyzer can display the measured parameter (for example, amplifier gain) for periods of up to 24 hours and then output the data to a digital plotter for hardcopy results.

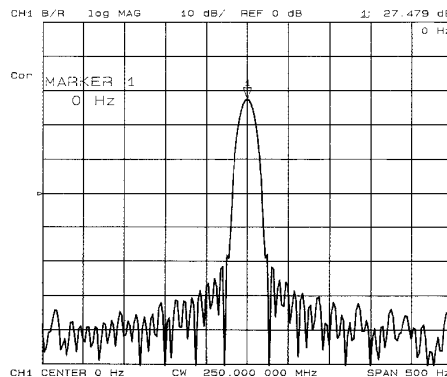
These “strip chart” plots are actually measurements as a function of time (time is the independent variable), and the horizontal display axis is scaled in time units. Transforms of these measurements result in frequency domain data. Such transforms are called forward transforms because the transform from time to frequency is a forward Fourier transform, and can be used to measure the spectral content of a CW signal. For example, when transformed into the frequency domain, a pure CW signal measured over time appears as a single frequency spike. The transform into the frequency domain yields a display that looks similar to a spectrum analyzer display of signal amplitude versus frequency.

Forward transform measurements

This is an example of a measurement using the Fourier transform in the forward direction, from the time domain to the frequency domain (refer to Figure 5-48).



(a) CW Time



(b) Transform to Frequency Domain

pg6189_c

Figure 5-48. Amplifier Gain Measurement

Interpreting the forward transform vertical axis

With the log magnitude format selected, the vertical axis displays dB. This format simulates a spectrum analyzer display of power versus frequency.

Interpreting the forward transform horizontal axis

In a frequency domain transform of a CW time measurement, the horizontal axis is measured in units of frequency. The center frequency is the offset of the CW frequency. For example, with a center frequency of 0 Hz, the CW frequency (250 MHz in the example) is in the center of the display. If the center frequency entered is a positive value, the CW frequency shifts to the right half of the display; a negative value shifts it to the left half of the display. The span value entered with the transform on is the total frequency span shown on the display. (Alternatively, the frequency display values can be entered as start and stop.)

Demodulating the results of the forward transform

The forward transform can separate the effects of the CW frequency modulation amplitude and phase components. For example, if a test device modulates the transmission response (S_{21}) with a 500 Hz AM signal, you can see the effects of that modulation as shown in [Figure 5-49](#). To simulate this effect, apply a 500 Hz sine wave to the analyzer rear panel EXT AM input.

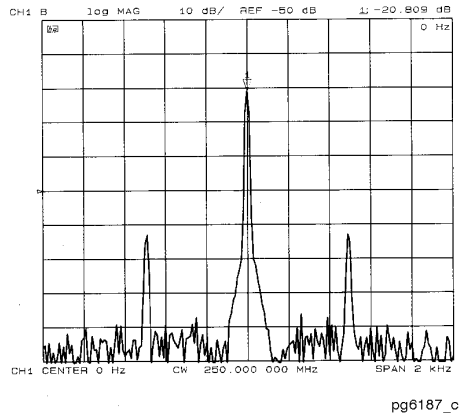
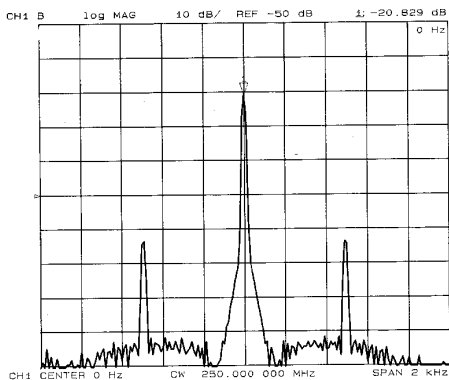


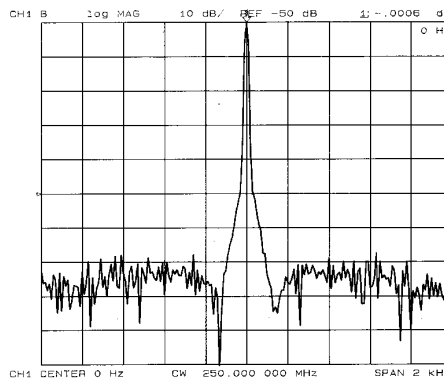
Figure 5-49. Combined Effects of Amplitude and Phase Modulation

Using the demodulation capabilities of the analyzer, it is possible to view the amplitude or the phase component of the modulation separately. The window menu includes the following softkeys to control the demodulation feature:

- | | |
|------------------|--|
| <i>DEMODOFF</i> | This is the normal preset state, in which both the amplitude and phase components of any test device modulation appear on the display. |
| <i>AMPLITUDE</i> | displays only the amplitude modulation, as illustrated in Figure 5-50a . |
| <i>PHASE</i> | displays only the phase modulation, as shown in Figure 5-50b . |



(a) Amplitude Modulation Component



(b) Phase Modulation Component

pg6188_c

Figure 5-50. Separating the Amplitude and Phase Components of Test-Device-Induced Modulation

Forward transform range

In the forward transform (from CW time to the frequency domain), range is defined as the frequency span that can be displayed before aliasing occurs, and is similar to range as defined for time domain measurements. In the range formula, substitute time span for frequency span.

Example:

$$\begin{aligned} \text{Range} &= (\text{Number of points} - 1) / \text{time span} \\ &= (201 - 1) / (200 \times 10^{-3}) \\ &= 1000 \text{ Hertz} \end{aligned}$$

For the example given above, a 201 point CW time measurement made over a 200 ms time span, choose a span of 1 kHz or less on either side of the center frequency (refer to [Figure 5-51](#)). That is, choose a total span of 2 kHz or less.

Understanding and Using Time Domain

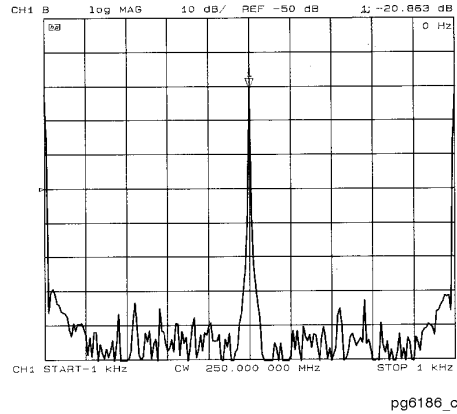


Figure 5-51. Range of a Forward Transform Measurement

To increase the frequency domain measurement range, increase the span. The maximum range is inversely proportional to the sweep time, therefore it may be necessary to increase the number of points or decrease the sweep time. Because increasing the number of points increases the auto sweep time, the maximum range is 2 kHz on either side of the selected CW time measurement center frequency (4 kHz total span). To display a total frequency span of 4 kHz, enter the span as 4000 Hz.

Instrument Preset State and Memory Allocation

The analyzer is capable of saving complete instrument states for later retrieval. It can store these instrument states into the internal memory, to the internal disk, or to an external disk. This section describes these capabilities in the following sections:

- instrument state definition
- memory allocation
- internal and external data storage
- description of analyzer state after preset

Types of memory and data storage

The analyzer utilizes two types of memory and can also utilize the internal disk drive or be connected to an external disk drive:

Volatile Memory

This is dynamic read/write memory, of approximately 2 Mbytes, that contains all of the parameters that make up the *current* instrument state. An instrument state consists of all the stimulus and response parameters that set up the analyzer to make a specific measurement.

Some data that you may think is part of the instrument state (such as calibration data and memory traces) are actually stored in battery-protected memory. Refer to “Battery-Protected Memory” to read more about the differences.

Volatile memory is cleared upon a power cycle of the instrument and, except as noted, upon instrument preset.

Battery-Protected Memory

This is read/write memory that is protected by a battery to provide storage of data when line power to the instrument is turned off. With this battery protection, data can be retained in memory for approximately 250 days at 70°C and for approximately 10 years at 25°C (typically.)

Battery-protected memory consists of a block of user-allocated memory and a block of fixed memory.

Instrument Preset State and Memory Allocation

The user-allocated memory is available for you to save the following data:

- instrument states
- measurement calibration data
- power meter calibration data
- user calibration kit definitions
- memory traces
- user preset

CAUTION

Even though calibration data is stored in battery-protected memory, if the associated instrument state is not saved, you will not be able to retrieve the calibration data after a power cycle.

The fixed memory is used to store the following data (you cannot change where this data is stored and it does not affect your memory availability for storing user-allocated data):

- GPIB addresses
- copy configuration (printer and plotter type, port, baud rate, handshake)
- power meter type (Agilent 436/438)
- display colors
- sequence titles
- sixth sequence
- power sensor calibration factors and loss tables
- user-defined calibration kits
- system Z0
- factory preset
- GPIB configuration
- display intensity default

The maximum number of instrument states, calibrations, and memory traces that can reside in battery-protected memory at any one time is limited to 31 instrument states, 128 calibrations (4 per instrument state, including the present instrument state), and 64 memory traces (2 per instrument state, including the present instrument state).

In addition, the number of instrument states and associated calibrations and memory traces are limited by the available memory. To display the amount of unused memory on the analyzer, press **SAVE/RECALL**. (Be sure you have selected *INTERNAL MEMORY* as your disk type.) In the upper righthand portion of the display, the value displayed as **Bytes free**: is the unused battery-protected memory. When you save to the internal memory, you will see the number of bytes free decrease. When you delete files, the number of bytes free increases. There is a maximum of 512 kbytes available.

If you have deleted registers since the last time the instrument was preset, the bytes available for you to use may be less than the actual “bytes free” that is displayed. Deleting registers to increase the available memory will work in cases where the registers being deleted and the registers needing to be added are of the same standard size (such as instrument states not having calibrations associated with them). In certain other cases, however, you may have to press PRESET after deleting registers so that the “bytes free” value equals the available memory value. During a preset, the analyzer runs a memory packer that defragments the free memory into one contiguous block.

[Table 5-10 on page 5-98](#) shows the memory requirements of calibration arrays and memory trace arrays to help you approximate memory requirements. For example, add the following memory requirements:

- a full 2-port calibration with 801 points (58 k)
- the memory trace array (4.9 k)
- the instrument state (3 k)

The total memory requirement is 65.9 kbytes. There is sufficient memory to store 7 calibrations of this type. However, the same calibration performed with 1601 points and 2 channels uncoupled would require 252 kbytes:

- a full 2-port calibration with 1601 points, two channels, uncoupled (230 k)
- the memory trace array (19 k)
- the instrument state (3 k)

Only two of these calibrations could reside in memory before the available memory would be depleted.

Instrument Preset State and Memory Allocation**Table 5-10. Memory Requirements of Calibration and Memory Trace Arrays**

Variable	Data Length (Bytes)	Approximate Totals (Bytes)			
		401 pts	801 pts	1601 pts	
		1 chan		1 chan	2 chan
Calibration Arrays					
Response	$N \times 6 + 52$	2.5 k	5 k	10 k	19 k
Response and Isolation	$N \times 6 \times 2 + 52$	5 k	10 k	19 k	38 k
1-Port	$N \times 6 \times 3 + 52$	7 k	14 k	29 k	58 k
E/O Response & Match	$N \times 6 \times 6 + 52$	14 k	28 k	56 k	113 k
O/E Response & Match	$N \times 6 \times 10 + 52$	24 k	47 k	94 k	188 k
2-Port	$N \times 6 \times 12 + 52$	29 k	58 k	115 k	230 k
Interpolated Cal	Same as above in addition to regular cal				
Power Meter Cal ^a	$(N^b \times 2 \times \text{number of channels}^c) + 208$	1 k	1.8 k	3.4 k	6.6 k
Measurement Data					
Memory Trace Array ^a	$N \times 6 + 52$	2.5 k	4.9 k	9.7 k	19 k
Instrument State ^d		3 k	3 k	3 k	3 k

a. This variable is allocated once per active channel.

b. The number of points that were set at the time the cal was turned on.

c. If the channels are coupled, this number is always 1. If the channels are uncoupled, this number refers to the number of channels that have power meter cal on.

d. This value may change with different firmware revisions.

The analyzer attempts to allocate memory at the start of a calibration. If insufficient memory is available, an error message is displayed. It is possible that the memory might be fragmented due to the sequence of saving and deleting states of various sizes. Another alternative would be to store the current state to disk and then press PRESET. The analyzer runs a memory packer which might regain some previously inaccessible memory. If memory is still inadequate, delete an instrument state and restart the calibration.

Storing Data to Disk

You can use the internal disk drive or connect an external disk drive for storage of instrument states, calibration data, measurement data, and plot files. (Refer to *Agilent 8702E User's Guide*, for more information on saving measurement data and plot files.)

The analyzer displays one file name per stored instrument state when you list the disk directory. In reality, several files are actually stored to the disk when you store the instrument state. Thus, when the disk directory is accessed from a remote system controller, the directory will show several files associated with a particular saved state. The maximum number of files that you can store on a disk depends on the directory size. You can define the directory size when you format a disk. Refer to “Preset Conditions” on page 2-43 for the default directory size for floppy disks and hard disks.

The maximum number of instrument states and calibrations that can reside on a disk is limited by the available disk space. To see the available disk space displayed on the analyzer, press SAVE RECALL. (Be sure you have selected either *INTERNAL DISK* or *EXTERNAL DISK* depending on your disk type.) In the upper righthand portion of the display, the value displayed as *Bytes free:* is the available disk space. If your disk is formatted in LIF, this value is the largest contiguous block of disk space. Since the analyzer is reporting the largest contiguous block of disk space, you may or may not see the bytes free number change when you delete files. If your disk is formatted in DOS, the number reported as bytes free is the total available disk space. That number is updated whenever you save to or delete files from the disk.

A disk file created by the analyzer appends a suffix to the file name. The suffix consists of one or two characters: the first character is the file type and the second is a data index. (Refer to Table 5-11 on page 5-99 for the definitions of each suffix character.)

Table 5-11. Suffix Character Definitions

Char 1	Definition	Char 2	Definition
I	Instrument State		
G	Graphics	1	Display Graphics
		0	Graphics Index
D	Error Corrected Data	1	Channel 1
		2	Channel 2
R	Raw Data	1 to 4	Channel 1, raw arrays 1 to 4
		5 to 8	Channel 2, raw arrays 5 to 8
F	Formatted Data	1	Channel 1
		2	Channel 2
C	Cal	K	Cal Kit
		R	Lightwave Receiver Cal Data
		S	Lightwave Source Cal Data

Table 5-11. Suffix Character Definitions

Char 1	Definition	Char 2	Definition
1	Cal Data, Channel 1	0	Stimulus State
		1 to 9	Coefficients 1 to 9
		A	Coefficient 10
		B	Coefficient 11
		C	Coefficient 12
2	Cal Data, Channel 2	0 to C	same as Channel 1
M	Memory Trace Data	1	Channel 1
		2	Channel 2

If correction is on at the time of an external store, the calibration set is stored to disk. (Note that inactive calibrations are not stored to disk.) When an instrument state is loaded into the analyzer from disk, the stimulus and response parameters are restored first. If correction is on for the loaded state, the analyzer will load a calibration set from disk that carries the same title as the one stored for the instrument state.

Conserving memory

If you are concerned about conserving memory, either internal memory or external disk space, some of the most memory-intensive operations include:

- two-port error correction
- interpolated error correction
- 1601 measurement points
- using time domain
- saving data arrays and graphics with the instrument state

Using saved calibration sets

When you are saving to internal memory, calibration sets are linked to the instrument state and measurement parameter for which the calibration was done. Therefore, a saved calibration can be used for multiple instrument states as long as the measurement parameter, frequency range, and number of points are the same. A full 2-port calibration is valid for any S-parameter mea-

surement with the same frequency range and number of points. When an instrument state is deleted from memory, the associated calibration set is also deleted if it is unused by any other state.

The following hints will help you avoid potential problems:

- If a measurement is saved with calibration and interpolated calibration on, it will be restored with interpolated calibration on.
- A calibration stored from one instrument and recalled by a different one will be invalid. To ensure maximum accuracy, always recalibrate in these circumstances.
- No record is kept in memory of the temperature when a calibration set was stored. Instrument characteristics change as a function of temperature, and a calibration stored at one temperature may be inaccurate if recalled and used at a different temperature.

Instrument Preset State and Memory Allocation**Table 5-12. Results of Power Loss to Non-Volatile Memory**

GPIB ADDRESSES are set to the following defaults:	
Agilent 8702E	16
USER DISPLAY	17
PLOTTER	5
PRINTER	1
POWER METER	13
DISK	0
DISK UNIT NUMBER	0
DISK VOLUME NUMBER	0
POWER METER TYPE is set to Agilent 438A/437	
INTERNAL REGISTER TITLES ^a are set to defaults: REG1 through REG32.	
EXTERNAL REGISTER TITLES ^a (store files) are set to defaults: FILE1 through FILE5.	
PRINT TYPE is set to default: MONOCHROME	
PRINTING/PLOTTING SETUPS are set to the following defaults:	
PARALLEL PORT	COPY
PLOTTER TYPE	PLOTTER
PLOTTER PLOT	SERIAL
PLOTTER BAUD RATE	9600
PLOTTER HANDSHAKE	Xon-Xoff
PRINTER TYPE	DESKJET
PRINTER PORT	PARALLEL
PRINTER BAUD RATE	19200
PRINTER HANDSHAKE	Xon-Xoff

a. Only applies to GPIB operation.

Index

A

- accessories, 2-5, 2-7
- accuracy enhancement
 - concepts, 5-17–5-66
 - effectiveness of, 5-35
 - what is, 5-17
- adapter kits, 2-6
- ADC, 5-7
- ADJ adjustment, 2-40
- admittance conversion, 5-15–5-16
- alphabetical listing of keys, 2-22–2-39, 2-40–2-42
- analog-to-digital converter, 5-7
- analyzer display features, 2-14
- attenuator, 5-3
- aux input connector, 2-40
- averaging, sweep-to-sweep, 5-7
- AVG menu map, 1-2
- avg status notation, 2-40

B

- bandpass mode
 - fault location measurements, 5-76
 - reflection measurements, 5-70
 - transmission measurements, 5-72
- battery backup for memory, 5-95
- bias connect connector, 2-40
- built-in test set, 5-3

C

- C? status notation, 2-40
- C2 = status notation, 2-40
- cabinet, 2-7
- cables
 - GPIB, 2-8
 - interface, 2-8
 - test port return, 2-6
- cal menu map, 1-3
- calibrated power level for power meter, 5-60
- calibration
 - channel coupling, 5-38
 - concepts, 5-17–5-66
 - cycle, 4-2
 - data lost, 5-96
 - device measurements, 5-38
 - for non-insertable devices, 5-55

- in memory, 5-95
- interpolated, 5-101
- interpolated error correction, 5-37
- measurement parameters, 5-38
- modifying kits, 5-43
- omitting isolation, 5-39
- power meter, 5-59
- response & match, 4-51
- restarting, 5-39
- saving data, 5-39
- sets, using, 5-100
- specifying kits, 5-43
- standard devices, 5-39
- temperature, 5-101
- TRL*/LRM*, 5-56
- using on multiple analyzers, 5-101
- validity of, 5-37
- verify performance of, 5-53
- calibration arrays memory requirements, 5-97
- calibration constants, viewing/modifying, 5-54
- calibration kit, 2-5
 - class assignments, 5-50
 - definitions, 5-43
 - modify menu, 5-44
 - standard definitions, 5-45
 - terminology, 5-43
- calibration standards
 - defining, 5-57
 - fabricating, 5-57
 - frequency response of, 5-40
 - fringe capacitance, 5-40
 - types, 5-41
- channel coupling calibration, 5-38
- characteristics
 - connector, 4-19
 - E/E, 4-24–4-49
 - E/O, 4-68–4-82
 - environmental, 4-22
 - error-corrected, 4-24–4-49
 - general, 4-18
 - measurement port, 4-24–4-47
 - O/E, 4-53–4-67
 - O/O, 4-83–4-93
 - operating, 4-22
 - Option 011, 4-10–4-17
 - standard instrument, 4-3–4-9
- classification, laser, 4-97
- CMOS memory, 5-95

Index

coefficient, linear reflection, 4-51
concepts
 accuracy enhancement, 5-17–5-66
 calibration, 5-17–5-66
 data processing, 5-5
 error correction, 5-17–5-66
 frequency domain, 5-67–5-94
 measurement calibration, 5-17–5-66
 response function, 5-10
 system overview, 5-2
 time domain, 5-67–5-94
connector
 10 MHz precision reference, 2-40
 aux input, 2-40
 bias connect, 2-40
 characteristics, 4-19
 DIN KYBD, 2-40
 EXT AM, 2-41
 EXT REF, 2-41
 EXT TRIG, 2-41
 for GPIB, 2-41
 limit test, 2-41
 parallel port, 2-41
 probe power, 2-42
 R channel, 2-13, 2-42
 rear panel, 2-16–2-18
 RS-232, 2-42
 test device, 5-3
 test seq, 2-42
 test set I/O interconnect, 2-42
constants, calibration, 5-54
continuous sample mode, 5-61
conversion
 menu, 5-15
 reflection impedance/admittance, 5-15
 transform, 5-8
 transmission impedance/admittance, 5-16
copy menu map, 1-5
Cor status notation, 2-40
crosstalk, 5-21
CW time-to-frequency domain, 5-90

D

data point, definition, 5-6
data processing, 5-4, 5-5
 flow diagram, 5-6
data retention time, internal memory, 4-21

data storage, types of, 5-95
declaration of conformity, 4-98
define standard menu, 5-45
defining calibration standards, 5-57
Del status notation, 2-40
delay block, 5-8
device measurements calibration, 5-38
dictionary reference, 2-2
dimensions of instrument, 4-22
DIN KYBD connector, 2-40
directivity, 5-19
directory size, 5-99
disk
 external, 5-98
 internal, 5-98
 storing data, 5-98
display
 features, 2-14
 formats, preset, 2-44
 memory, 5-9
display menu map, 1-6
documents, reference, 2-20
DOS format, 2-8
dynamic range, 4-3

E

E/E characteristics, 4-24–4-49
E/O characteristics, 4-68–4-82
electrical offset standards, 5-40
engaging hold mode, 2-42
environmental characteristics, 4-22
error correction
 concepts, 5-17, 5-66
 full two-port calibration, 5-35
 one-path two-port calibration, 5-35
 one-port, 5-34
 raw data, 5-4
 response and isolation, 5-34
 response calibration, 5-34
error messages
 alphabetically listed, 3-3
 numerically listed, 3-24
error model
 one-port, 5-22
 two-port, 5-28
EXT AM connector, 2-41
EXT REF connector, 2-41

ext status notation, 2-40
 EXT TRIG connector, 2-41
 external disk, 5-98

F

fault location measurements
 using low pass mode, 5-76
 file names, 5-99
 flatness measurement uncertainty, 4-51
 format arrays, 5-9
 format menu map, 1-6
 formatting data, 5-9
 forward transform, 5-91
 demodulating the results, 5-92
 range, 5-93
 frequency domain
 concepts, 5-67–5-94
 transform from CW time, 5-90
 frequency response, 5-22
 of calibration standards, 5-40
 frequency-to-time domain, 5-67
 Fresnel reflection, 4-51
 fringe capacitance, 5-40
 front panel features, 2-12
 full two-port calibration error correction, 5-35

G

Gat status notation, 2-41
 gating, 5-8
 time domain, 5-88
 general characteristics, 4-18
 GPIB
 cables, 2-8
 connector, 2-41
 interface, 4-96

H

H=2 status notation, 2-41
 H=3 status notation, 2-41
 Hld status notation, 2-41
 hold mode engaged, 2-42
 humidity, 4-2

I

IF detection, 5-7
 impedance conversion, 2-6
 initializing
 DOS, 2-8
 LIF, 2-8
 input ports menu, 5-15
 input power, 4-51
 insertion loss, 4-51
 instrument
 dimensions, 4-22
 options, 2-3
 specifications and characteristics, 4-3–4-9
 instrument state
 in memory, 5-95
 memory requirements, 5-97
 interface
 cables, 2-8
 GPIB, 4-96
 internal memory data retention time, 4-21
 interpolated
 calibration, 5-101
 error correction, 5-37
 interpolation, power meter calibration, 5-61
 isolation, 5-21
 calibration, 5-39

K

key menu maps, 1-2, 1-17
 keyboards, 2-9
 keycap listing, 2-22–2-39, 2-40–2-42
 kit
 adapter, 2-6
 calibration, 2-5
 verification, 2-5

L

label class menu, 5-53
 label kit menu, 5-53
 label standard menu, 5-50
 laser classification, 4-97
 LIF format, 2-8
 limit test connector, 2-41
 LINE key, 2-41
 linear reflection coefficient, 4-51
 line-power

Index

- cables, 2-10
- listing of keys, 2-22–2-39, 2-40–2-42
- load match, 5-20
- local menu map, 1-7
- loss of data, power meter calibration, 5-60
- low pass mode
 - reflection measurements, 5-75
 - setting frequency range, 5-74
 - transmission measurements, 5-78

M

- man status notation, 2-41
- marker fctn menu map, 1-9
- marker menu map, 1-8
- marker search menu map, 1-10
- masking, time domain, 5-81
- mass storage, 2-8
- meas menu map, 1-10
- measurement
 - calibration concepts, 5-17–5-66
 - parameters calibration, 5-38
 - port characteristics, 4-24–4-47
 - repeatability, 4-94
 - selecting, 5-14
 - times, typical, 4-18
- measurement errors
 - causes of, 5-18
 - correcting for, 5-34
 - crosstalk, 5-21
 - directivity, 5-19
 - frequency response, 5-22
 - isolation, 5-21
 - load match, 5-20
 - source match, 5-20
 - tracking, 5-22
- measurement uncertainty, flatness, 4-51
- memory
 - battery backup, 5-95
 - CMOS, 5-95
 - conserving, 5-100
 - display, 5-9
 - external disk, 5-98
 - internal disk, 5-98
 - non-volatile, 5-95
 - requirements, 5-97
 - saving data, 5-95
 - types of, 5-95

- volatile, 5-95
- memory trace arrays
 - memory requirements, 5-97
- memory-intensive operations, 5-100
- menu
 - conversion, 5-15
 - define standard, 5-45
 - inport ports, 5-15
 - label class, 5-53
 - label kit, 5-53
 - label standard, 5-50
 - S-parameter, 5-15
 - specify class, 5-50
 - specify offset, 5-48
- menu map, 1-2
 - AVG, 1-2
 - cal, 1-3
 - copy, 1-5
 - display, 1-6
 - format, 1-6
 - local, 1-7
 - marker, 1-8
 - marker fctn, 1-9
 - marker search, 1-10
 - meas, 1-10
 - power, 1-11
 - preset, 1-12
 - save/recall, 1-13
 - scale ref, 1-14
 - seq, 1-15
 - sweep setup, 1-11
 - system, 1-17
- menu maps, 1-17
- microprocessor, 5-4
- minimum loss pad, 2-6
- modes of operation, power meter calibration, 5-61
- modifying
 - calibration kit menu, 5-44
 - calibration kits, 5-43
- monitor, 2-9
- multiplexer, 5-4

N

- noise declaration, 4-97
- non-insertable devices
 - calibrating for, 5-55

non-volatile memory, 5-95

O

O/E characteristics, 4-53–4-67
 O/O characteristics, 4-83–4-93
 Of? status notation, 2-41
 offset, 5-9
 Ofs status notation, 2-41
 omitting isolation calibration, 5-39
 one-path/two-port error correction, 5-35
 one-port
 error correction, 5-34
 error model, 5-22
 operating characteristics, 4-22
 operation, of the analyzer, 5-2
 Option 011
 specifications and characteristics, 4-10–4-17
 options, instrument, 2-3
 overview of the system, 5-2

P

P? status notation, 2-41, 3-17
 P0 status notation, 2-41
 parallel port connector, 2-41
 PC status notation, 2-41
 PC? status notation, 2-41
 peripheral equipment, required, 5-4
 phase shift, 5-41
 plotters, 2-7
 power level, calibrating, 5-60
 power loss correction list, 5-63
 power menu map, 1-11
 power meter calibration, 5-59
 accuracy, 5-64
 applications, 5-59
 compatible sweep types, 5-60
 continuous sample mode, 5-61
 interpolation, 5-61
 loss of data, 5-60
 modes of operation, 5-61
 power loss correction list, 5-63
 power sensor calibration data, 5-64
 sample-and-sweep mode, 5-62
 speed, 5-64
 stimulus parameters, 5-64
 power sensor calibration factor list, 5-64

preset display formats, 2-44
 preset key, 2-41
 preset menu map, 1-12
 primary applications, power meter calibration,
 5-59
 printers, 2-7
 Prm status notation, 2-42
 probe power connector, 2-42
 processing data, 5-4

R

R channel connector, 2-13, 2-42
 rack mount cabinet, 2-7
 range, time domain, 5-85
 ratio calculations, 5-7
 raw data
 arrays, 5-7
 error correction, 5-4
 rear panel
 connectors, 2-16–2-18
 rear panel features, 2-16
 receiver block, 5-4
 receiver measurement repeatability, 4-94
 reference documents, 2-20
 reflection
 impedance conversion, 5-15
 sensitivity, 4-51
 reflection measurements
 using bandpass mode, 5-70
 using low pass mode, 5-75
 regulatory information, 4-97
 relative velocity factor, adjusting of, 5-70
 repeatability, measurement, 4-94
 required peripheral equipment, 5-4
 resolution, time domain, 5-85
 response & match calibration, 4-51
 response calibration error correction, 5-34
 response function, 5-10
 response/isolation calibration error correction,
 5-34
 restarting a calibration, 5-39
 return loss, 4-51
 RS-232 connector, 2-42

S

sample-and-sweep mode, 5-62

Index

- sampler/IF correction, 5-7
 - sampler/mixer, receiver block, 5-4
 - save/recall menu map, 1-13
 - saving calibration data, 5-39
 - scale, 5-9
 - scale ref menu map, 1-14
 - selecting the measurement, 5-14
 - sensitivity, reflection, 4-51
 - seq menu map, 1-15
 - signal power, 4-51
 - signal separation devices, 5-3
 - Smo status notation, 2-42
 - smoothing, 5-9
 - softkey listing, 2-22–2-39, 2-40–2-42
 - softkey menu maps, 1-2, 1-17
 - source, 5-3
 - source match, 5-20
 - S-parameter menu, 5-15
 - S-parameters, 5-11
 - specifications
 - definition of terms, 4-2
 - Option 011, 4-10–4-17
 - standard instrument, 4-3–4-9
 - specify class menu, 5-50
 - specify offset menu, 5-48
 - specifying calibration kits, 5-43
 - speed/accuracy, power meter calibration, 5-64
 - standard types, calibration, 5-41
 - standards, calibration, 5-39
 - start values possible, 2-14
 - step attenuator, 5-3
 - stimulus
 - start value, 2-14
 - stop value, 2-15
 - stimulus parameters, power meter calibration, 5-64
 - stop values possible, 2-15
 - storing
 - data, methods of, 5-95
 - to external disk, 2-8
 - to internal disk, 2-8
 - to internal memory, 2-8
 - sweep
 - definition, 5-6
 - types, power meter calibration, 5-60
 - sweep setup menu map, 1-16
 - synthesized source, 5-3
 - system
 - accessories, 2-7
 - cabinet, 2-7
 - overview, 5-2
 - performance, 4-50
 - system menu map, 1-17
 - systematic errors
 - characterizing, 5-22
- ## T
- temperature range, 4-2
 - test device connection, 5-3
 - test fixtures, transistors, 2-7
 - test seq connector, 2-42
 - test set I/O interconnect, 2-42
 - test set, built-in, 5-3
 - time domain
 - bandpass, 5-69
 - bandpass mode, 5-67
 - concepts, 5-67–5-94
 - gating, 5-88
 - general theory, 5-68
 - low pass, 5-67–5-78
 - masking, 5-81
 - range, 5-85
 - reflection bandpass mode, 5-70
 - relative velocity factor, 5-70
 - resolution, 5-85
 - transform, 5-8
 - transmission bandpass mode, 5-72
 - windowing, 5-82
 - time-to-frequency domain, 5-67
 - trace math operation, 5-8
 - tracking, 5-22
 - transform
 - CW time-to-frequency domain, 5-90
 - forward measurements, 5-91
 - frequency-to-time domain, 5-67
 - time-to-frequency domain, 5-67
 - transform modes
 - time domain bandpass, 5-67
 - time domain low pass impulse, 5-67
 - time domain low pass step, 5-67
 - transistor test fixtures, 2-7
 - transmission impedance conversion, 5-16
 - transmission measurements
 - using bandpass mode, 5-72
 - using low pass mode, 5-78

TRL*/LRM* calibration, 5-56
tsH display annotation, 2-42
two-port error
 correction, 5-35
 model, 5-28
typical measurement times, 4-18
typical system performance, 4-50

V

vector error correction, 5-8
verification kit, 2-5
verifying calibration performance, 5-53
volatile memory, 5-95

W

weight, 4-22
windowing, 5-8
 time domain, 5-82

Index